

Thermo Pride

wood / coal furnace

MODEL NO. WC-20, WC-27

INSTALLATION AND MAINTENANCE INSTRUCTIONS

PLEASE READ THESE INSTRUCTIONS PRIOR
TO INSTALLATION AND FIRING

Obsolete Per Ecn: 2301
Date: 6-25-92

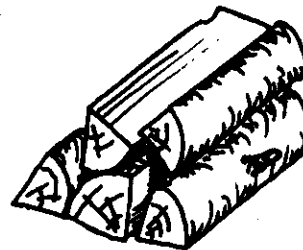
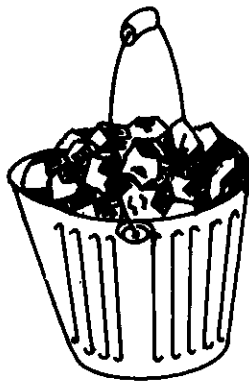

FOR YOUR SAFETY
DO NOT STORE GAS OR OTHER FLAMMABLE
LIQUIDS NEAR THIS OR ANY OTHER
APPLIANCE.

SERVICING
SERVICE TO THIS UNIT MUST BE PERFORMED
BY QUALIFIED SERVICE PERSONNEL

THESE INSTRUCTIONS MUST BE LEFT WITH HOMEOWNER

Thermo Products, Inc.
Box 217
North Judson, Indiana 46366

Thermo Products, Inc.
Box 237
Denton, North Carolina 27239

MW-100
Rev. 5/89

INDEX

I. INTRODUCTION

A. Description.....	1
B. Codes.....	1
C. Features.....	2

II. INSTALLATION

A. Chimney.....	3
B. Furnace Location.....	9
C. Clearances.....	9
D. Flue Pipe Connection.....	11
E. Ventilation For Combustion Air.....	12
F. Ductwork.....	12
G. Installation of An Indoor Coil.....	19
H. Installation of Two Piece Door Handles.....	20
I. Damper Motor Installation.....	21
J. Wiring.....	23
K. Furnace Disassembly Instructions.....	24
L. Refractory Replacement.....	25

III. Operation

A. Do's and Dont's.....	27
B. Lighting Procedure.....	28
C. Power Failure.....	29

IV. Fuel

A. Coal.....	29
B. Wood.....	32
C. Storage of Fuel.....	34

V. MAINTENANCE

A. Ash Removal.....	34
B. Regular Maintenance.....	35
C. Periodic.....	36

VI. CHIMNEY FIRE.....37

VII. TROUBLE SHOOTING PERFORMANCE PROBLEMS.....38

INTRODUCTION

Description

The WC/20 and WC/27 wood or coal central furnaces can be used as a supplementary or independent heat source for the home. The WC/20 and WC/27 must be installed by a qualified furnace installer. All instructions must be read before any attempt is made to install or operate the wood/coal furnace. For future reference, - S A V E T H E S E I N S T R U C T I O N S !

CODES

All installations must comply with local building codes or, in the absence local codes, with the National Fire Protection Association (NFPA) Standards (NFPA-211 & NFPA-97M), the Uniform Building Code, National Electrical Code ANSI/NFPA latest edition and these instructions. The installation must be inspected by the State and/or local Building Inspector, if required.

NOTE: THIS FURNACE IS NOT APPROVED OR RECOMMENDED FOR USE IN MOBILE HOMES.

FEATURES

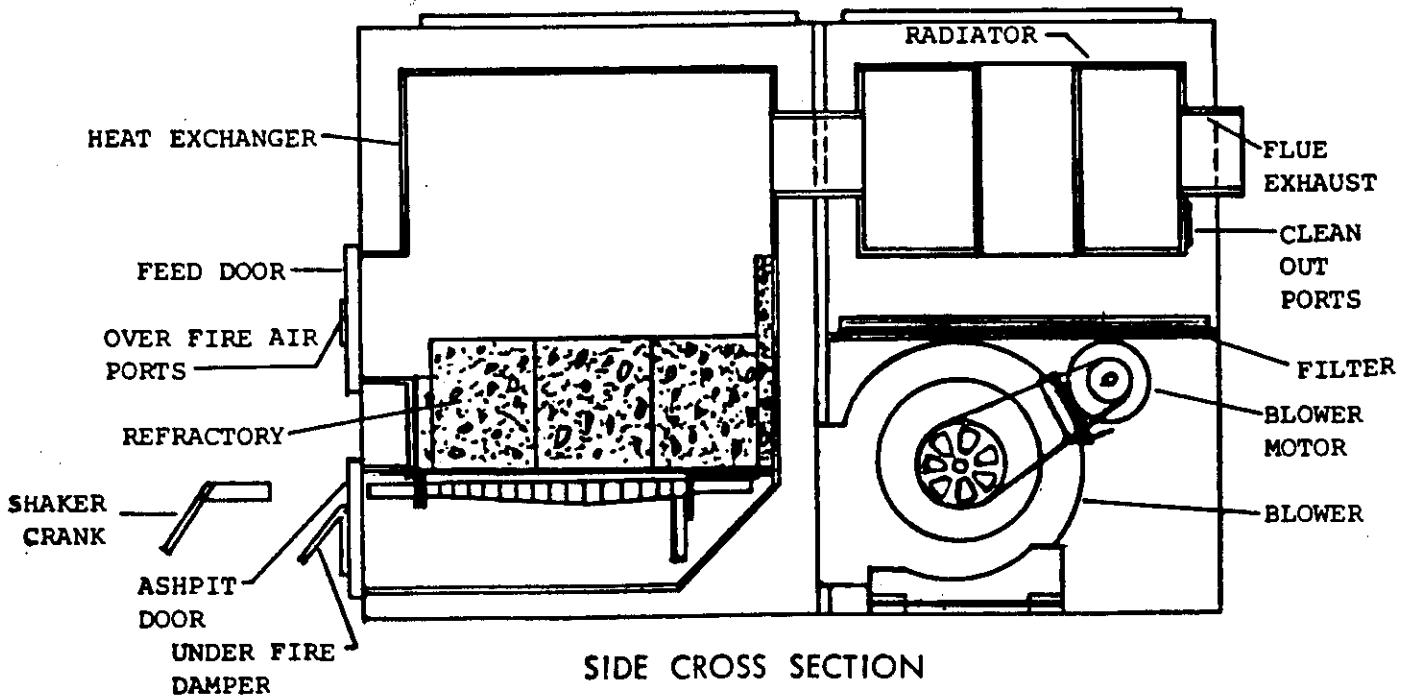

HEAT EXCHANGER: Commercial quality carbon steel, 10 gauge.
WC/20 can take 20" length log.....WC/27 can take 27" length logs.

All installations and services must be performed by qualified service personnel.

FEED DOOR: Cast Iron, 18" x 11" opening, provides access for refueling.

OVER-FIRE AIR PORTS: Adjustable ports which introduce secondary combustion air into the fire.

REFRACTORY: Ceramic brick which protect the metal of the heat exchanger when firing.

ASHPIT DOOR: Cast Iron, 18" X 11" opening, provides access for ash removal just below grate level.

GRATES: Two cast iron grates which swivel to dump ash into the ashpit below.

SHAKER CRANK: Fits onto either grate providing a means to turn grates to shake ashes down.

UNDERFIRE DAMPER: Introduces primary combustion air beneath the fire.

FLUE EXHAUST: WC/20 7" round flue, WC/27 8" round flue.

CLEAN-OUT PORTS: Provide access into the radiator for cleaning and inspection.

RADIATOR: 13 gauge Corten Steel, provides an additional source of convected heat.

FILTER: Permanent washable type, WC/20 - 20" x 16"; WC/27 - 20" x 20".

BLOWER MOTOR: 115 Volt, 1725 RPM, WC/20 - 1/2 HP Direct Drive, 4-SP, 3/4 HP Direct Drive, 4-SP.

BLOWER: Direct Drive blower, WC/20 - 10" Blower, WC/27 - 12" Blower.

The WC/20 and WC/27 can be ordered with an optional backdraft damper, which must be field installed. (Refer to the following diagram). The damper consists of swing shutter-like pieces supported by rods which fit into holes on two side tabs which are placed on the blower housing outlet.

The purpose of the blower backdraft damper is to stop air from circulating back through the wood/coal furnace when it is not operating. This damper may be important when the wood/coal furnace is installed with a companion oil or gas furnace. When the companion furnace is operating and the wood/coal furnace is not, air cannot circulate back through the wood/ coal furnace and into the return air plenum of the companion furnace thus, in effect, reducing normal circulation into the home's duct system.

All installations and services must be performed by qualified service personnel.

A backdraft damper can also be installed on the companion, gas or oil furnace, to facilitate normal air circulation when the WC furnace is operating. (See illustration on following page).

BACKDRAFT DAMPER ILLUSTRATION

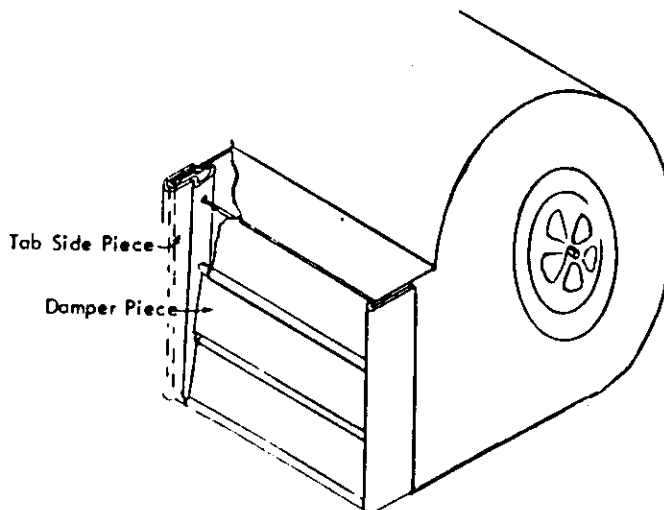

Each furnace comes equipped with a thermostat and a motorized damper motor to control the under-fire damper and the barochek draft regulator (to be installed in the flue pipe). When there is need for additional heat within the home, as determined by the thermostat setting, the under-fire damper will open and the barochek draft regulator will be allowed to swing freely (to achieve the maximum draft through the furnace provided the chimney is capable of creating sufficient draft). This, in turn, will increase the intensity of the fire provided there is sufficient fuel in the furnace. When the thermostat is satisfied, the ashpit door damper is automatically closed and the barochek draft regulator spaced open.

The barochek draft control, which is field installed, is located in the flue pipe connection to the chimney. Refer to instructions enclosed with barochek control for exact installation location and proper adjustment.

INSTALLATION

CHIMNEY:

The chimney is one of the most important system components affecting the performance of a solid fuel burning furnace. Besides being properly sized, it must be of sound construction and be thoroughly inspected by a qualified person prior to use with the wood and coal furnace. Prior to installation, check Local and/or State Codes & Ordinances on acceptance of a prefab-type chimney. Some areas disallow installation of this type of chimney and require a masonry lined chimney. A minimum of a 8" round for Wood/Coal 20 and 9" round for Wood/Coal 27 insulated prefab chimney would be required, if the prefab-type is acceptable.

All installations and services must be performed by qualified service personnel.

Thermo Products, Inc. recommends a masonry chimney flue, with the wood and coal furnace being the only appliance used on that chimney flue as the best installation. In such a case, the minimum square inch flue area required for the WC/20 is 38.5 square inches and for a WC/27 is 50.3 square inches. When a gas or oil furnace, water heater, or any other appliance is connected to the same chimney flue as the wood/coal, the inside dimension of the chimney flue should be equal to the size of the largest flue - plus 50% of the square inch area of all the smaller flue pipes.

EXAMPLE: Formula $\pi r^2 = \text{Sq. Inch Area of a Circle}$
 $\pi = 3.1416$
 $r = \text{Radius}$

Sq. Inch Area of-

8" Pipe = 50.3 sq. in.

6" Pipe = 28.3 sq. in.

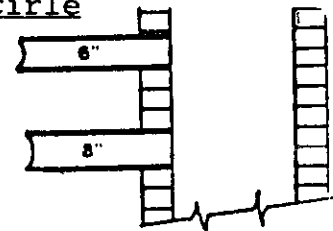

$50.3 + 1/2 (28.3) = 64.6 \text{ sq. in. of chimney area required}$
Approximately 8" x 8" Chimney Required

Following is a check list with illustrations to aid you in inspecting the chimney. Do not leave any item uninspected.

1. The chimney should be thoroughly inspected for sound construction. The inside of the chimney can be most easily inspected by inserting a mirror in the flue pipe hole. Cracks, loose mortar joints, or broken flue tile can cause air leaks as well as a place for soot and creosote to form and build-up. Air leaks can allow cold air to enter, which will weaken draft as well as to make it more difficult to initiate a draft.

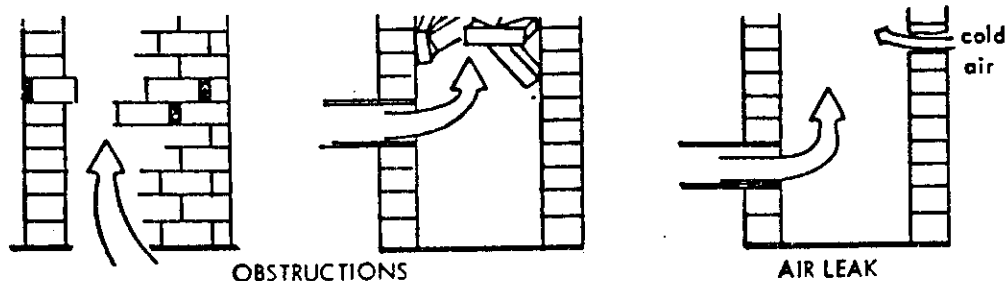

2. The chimney should be as straight as possible. An off-set chimney has a higher risk for build-up of soot and creosote. The best solution to this problem is to reconstruct the chimney so it goes straight up. If this is not possible, make the off-set as smooth as possible. (See drawing on next page).

All installations and services must be performed by qualified service personnel.

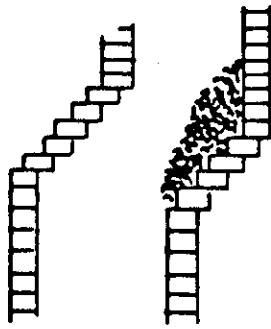

ROUGH OFF-SET

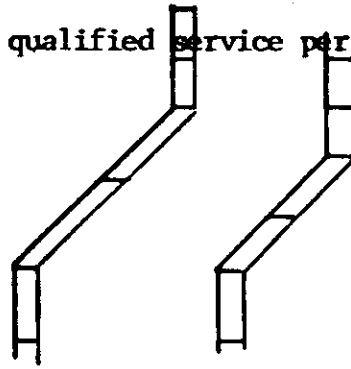

SMOOTH OFF-SET

3. The chimney should be proportioned as squarely as possible to the square inch size required. A chimney made in a long rectangular configuration will cause friction as the heat ascends making the chimney restrictive to the flow of the flue products. (See drawing below).

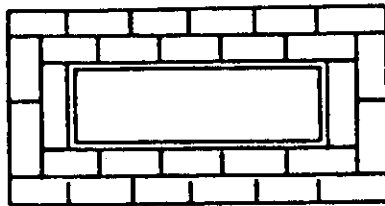

BAD

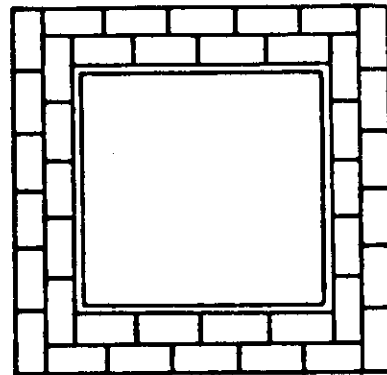

GOOD

4. Never install the wood/coal furnace in the same chimney with a fireplace. An open fireplace will admit cold air which will weaken the draft and hinder the operation of the furnace. Even a chimney with a metal damper cannot be made air tight.

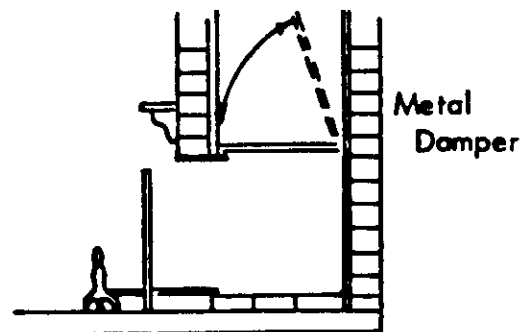

MAJOR COLD AIR LEAK

All installations and services must be performed by qualified service personnel.

Other appliances, connected to the same chimney with the WC/Furnace can also be a source of a cold air leak. A tight damper in the flue pipe of the other appliance can remedy the problem if that appliance will not be used when the wood/coal is in operation. If the appliance is an oil or gas unit, an automatic vent damper can be used.

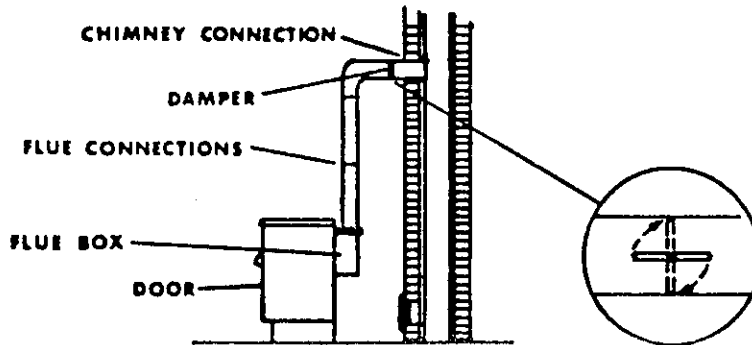

6. Some chimneys have a clean-out pan located at the bottom of the chimney. The door on the chimney that provides access to this pan must be made air tight.

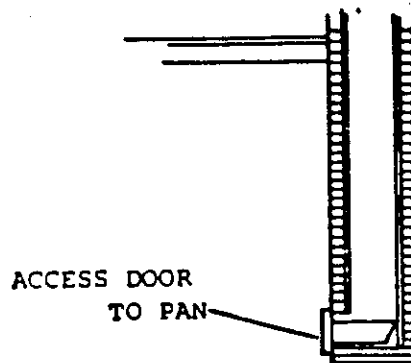

7. Chimney height is important. The top of the chimney should not be sheltered by a peak in the roof or surrounding buildings, trees, or terrain. If the roof peak is higher than the chimney, build the chimney up to a height of at least 2' above roof peak.

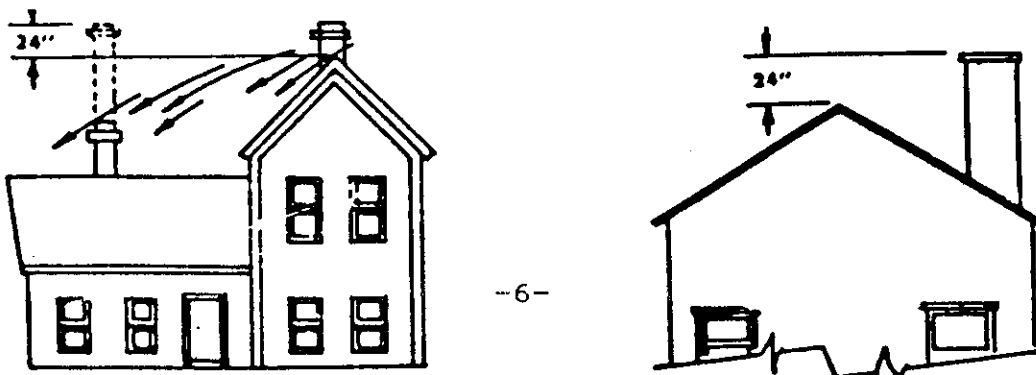

All installations and services must be performed by qualified service personnel.

When terrain or other high objects are sheltering the chimney, as shown below, a Flaring Hood mounted on the top of the chimney may prevent down-drafts.

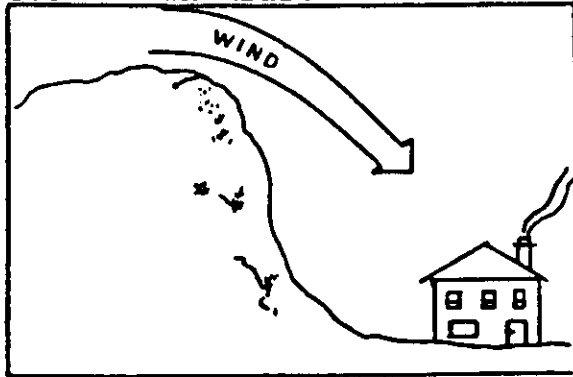

TERRAIN ABOVE CHIMNEY

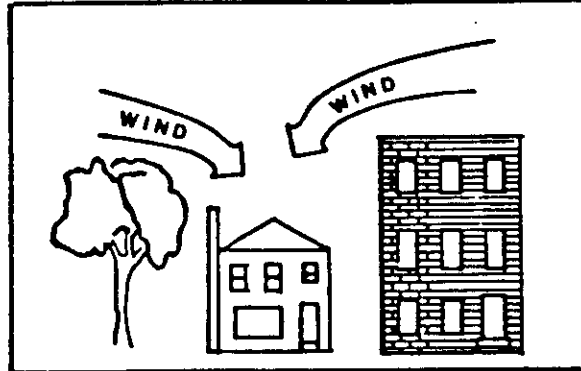

TREES OR BUILDINGS ABOVE CHIMNEY

The Flared Hood should be pyramid shaped on the top with a perfectly flat surface immediately above the chimney outlet. The hood should be attached by four (4) iron supports. Four plated flaring down, as shown below, can be added to help insure that the wind will pass straight over the chimney outlet. The four iron supports should be equal to the width of the chimney opening in height.

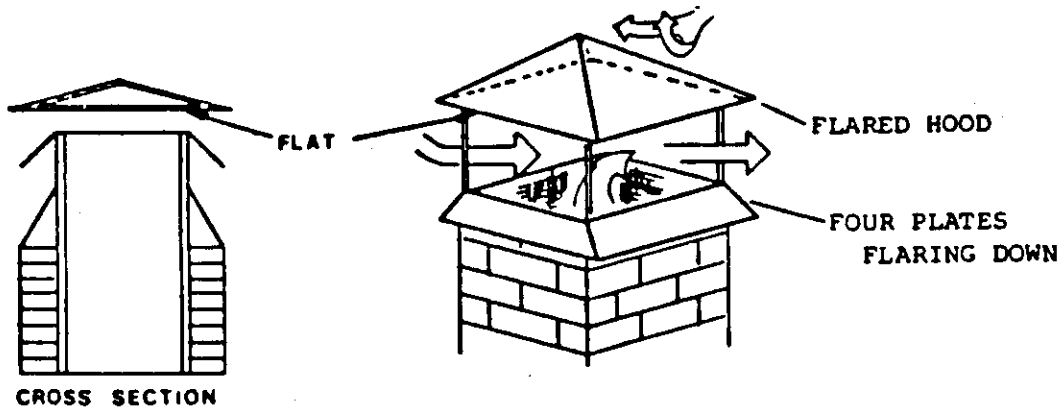

8. The pipe leading from the unit to the chimney should never descend into the chimney. A rise of 4" per 1' of pipe is preferred. (See drawing below).

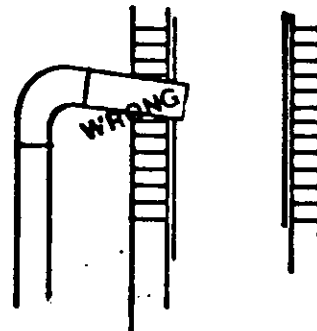

All installations and services must be performed by qualified service personnel.

9. Never extend the flue pipe connecting the WC/Furnace to the chimney past the inner wall of the chimney.

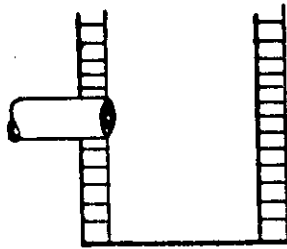

RIGHT

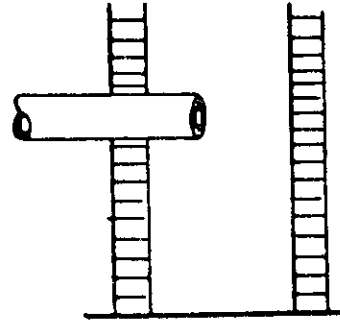

WRONG

If the pipe is extended too far in, you will restrict the flow of the flue products by reducing the area immediately outside the pipe.

10. A chimney that is located on the outside of a house may produce a weak or inadequate draft. The exposed sides of the chimney may cool the flue gas to a point that will allow condensing of the moisture contained in wood smoke and pose a serious problem. Insulation around the exposed sides of the chimney wall to the outside and, therefore improve draft and lessen creosote condensation. A chase can be built around the chimney to protect the insulation.

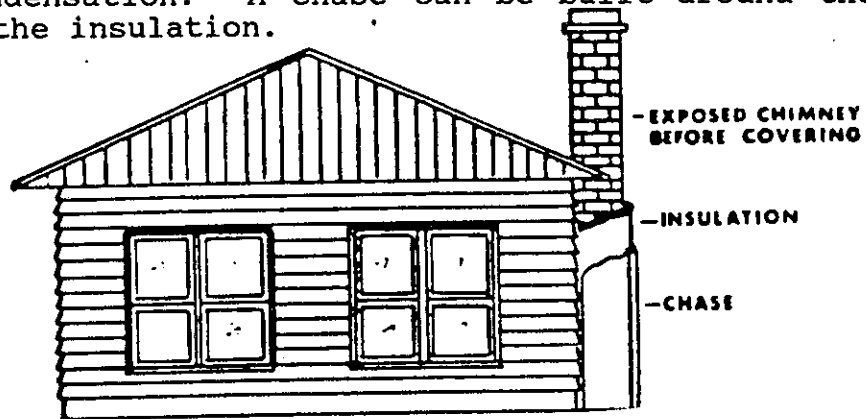

11. If an adequate draft of .04" to .06" water column cannot be achieved after the above conditions discussed, review construction and location of the chimney for any possible causes of restrictions, blockage or abnormal air flow around the top of the chimney. In "extreme" cases, where no solution can be found, a draft inducer may overcome the condition.

Measure the draft reading in the flue pipe as close to the WC/Furnace as possible ahead of the barochek draft regulator. Measure the draft while the WC/Furnace is in the call for heat mode so the furnace will produce the strongest draft possible with the under-fire damper and draft regulator at those particular settings. Use a draft guage which measures in hundredths of an inch water column.

All installations and services must be performed by qualified service personnel.

FURNACE LOCATION

When selecting the WC/20 and WC/27 furnace location, keep in mind the chimney location, existing ductwork arrangement and position of a companion oil, gas or electric furnace. It is advisable to install the WC/Furnace in a central location in relation to outlet registers to aid in gravity heat flow during power failure periods. The following sections of the instructions should help in selecting a proper location.

NOTE: The furnace must be installed lower than the ductwork to allow for proper air flow across the heat exchanger. Ideal places are: basements or cellars.

CLEARANCES

Definitions of "COMBUSTIBLE MATERIAL" and "NON-COMBUSTIBLE MATERIAL" as issued by National Fire Protection Association (NFPA) - Z11-1-3.

COMBUSTIBLE MATERIAL

Material made of or surfaced with wood, compressed paper, plant fibers, plastics, or other material that will ignite and burn whether flame proof or not, or whether plastered or unplastered.

NON-COMBUSTIBLE MATERIAL

Material which will not ignite and burn; such materials consisting entirely of steel, iron, brick, tile, concrete, slate, asbestos, glass, or plaster - combination thereof.

Notice: The WC/20 and WC/27 must be installed on a NON-COMBUSTIBLE FLOOR ONLY

Minimum clearances to unprotected combustible surfaces around the WC/Furnace are as follows: =

CLEARANCE TO COMBUSTIBLE MATERIAL (IN.)

TOP & SIDES OF RETURN & WARM AIR PLENUM	DUCTWORK WITHIN 3' OF FURNACE	DUCTWORK 3 - 6' FROM FURNACE	FRONT OF FURNACE	SIDES OF FURNACE	REAR OF FURNACE	FLUE PIPE
18	18	6	48	18	30	18

All installations and services must be performed by qualified service personnel.

See the following Table for reduced clearances provided the additional construction specified under the heading "TYPE OF PROTECTION" is installed.

IT IS NECESSARY TO ADHERE TO THE INSTALLATION CLEARANCES AND RESTRICTIONS-

Table VI
Reduction of Clearances with Specified Forms of Protection

Type of protection applied to and covering all surfaces of combustible material within the distance specified as the required clearance with no protection (See Figures 6, 7, and 8)	Where the required clearance with no protection from appliance, vent connector, or single wall metal pipe is:									
	36 inches	18 inches	12 inches	9 inches	6 inches					
	Allowable Clearances with Specified Protection, inches									
	Sides and Above Rear	Sides and Above Rear	Sides and Above Rear	Sides and Above Rear	Sides and Above Rear					
(a) 3/2 in. thick masonry wall without ventilated air space	—	24	—	12	—	9	—	6	—	5
(b) 1/2 in. insulation board over 1 in. glass fiber or mineral wool batts	24	18	12	9	9	6	6	5	4	3
(c) 0.024 (24 gauge) sheet metal over 1 in. glass fiber or mineral wool batts reinforced with wire on rear face with ventilated air space	18	12	9	6	6	4	5	3	3	3
(d) 3/4 in. thick masonry wall with ventilated air space	—	12	—	6	—	6	—	6	—	6
(e) 0.024 (24 gauge) sheet metal with ventilated air space	18	12	9	6	6	4	5	3	3	2
(f) 1/2 in. thick insulation board with ventilated air space	18	12	9	6	6	4	5	3	3	3
(g) 0.024 (24 gauge) sheet metal with ventilated air space over 0.024 (24 gauge) sheet metal with ventilated air space	18	12	9	6	6	4	5	3	3	3
(h) 1 in. glass fiber or mineral wool batts sandwiched between two sheets 0.024 (24 gauge) sheet metal with ventilated air space.	18	12	9	6	6	4	5	3	3	3

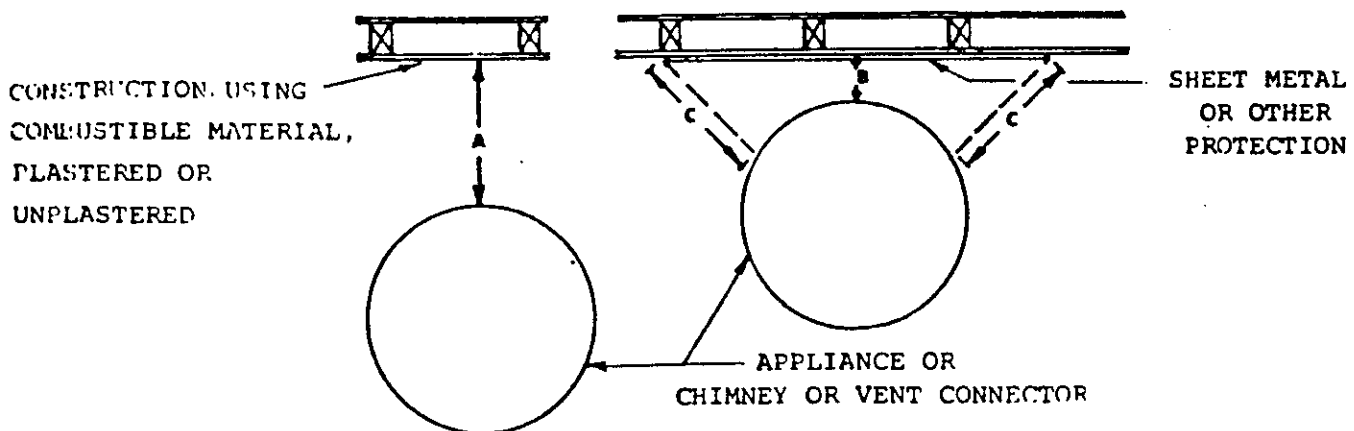

A. equals the required clearance with no protection.

B. equals the reduced clearance permitted in accordance with the Table above. The protection applied to the construction using combustible material should extend far enough in each direction to make C equal to A.

All installations and services must be performed by qualified service personnel.

FLUE PIPE CONNECTION:

When connecting the wood/coal furnace to the chimney, the connection should contain no more than two 90° elbows and have a horizontal reach of 8' maximum to the chimney. A rise of 4" per 1' of flue pipe is recommended for horizontal flue pipe connection runs. If any of the above conditions are not met, the flue pipe connection may be excessively restrictive.

The flue pipe must be made of 24 gauge (or thicker) corrosion-resistant steel.

When connecting two furnaces to a common chimney flue, always make certain that the WC/furnace connects above the flue pipe of the other unit, unless local codes specify otherwise.

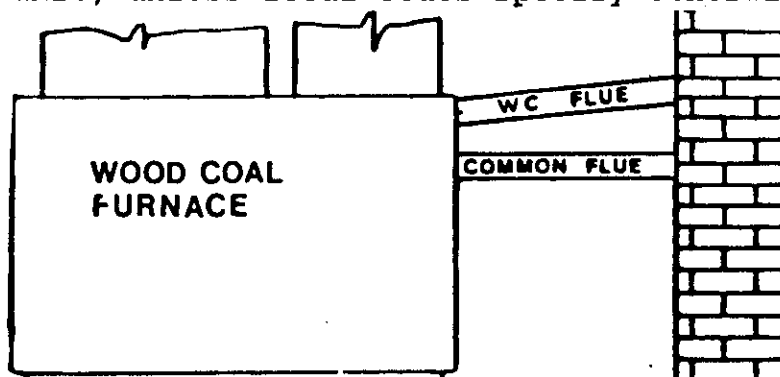

NOTE: No more than 2-90° ell's should be used when making the connection between the wood/coal furnace and the chimney. It is recommended that the maximum rise of the flue pipe connection from the wood/coal furnace be located within the first 2' of the furnace to help insure a proper draft.

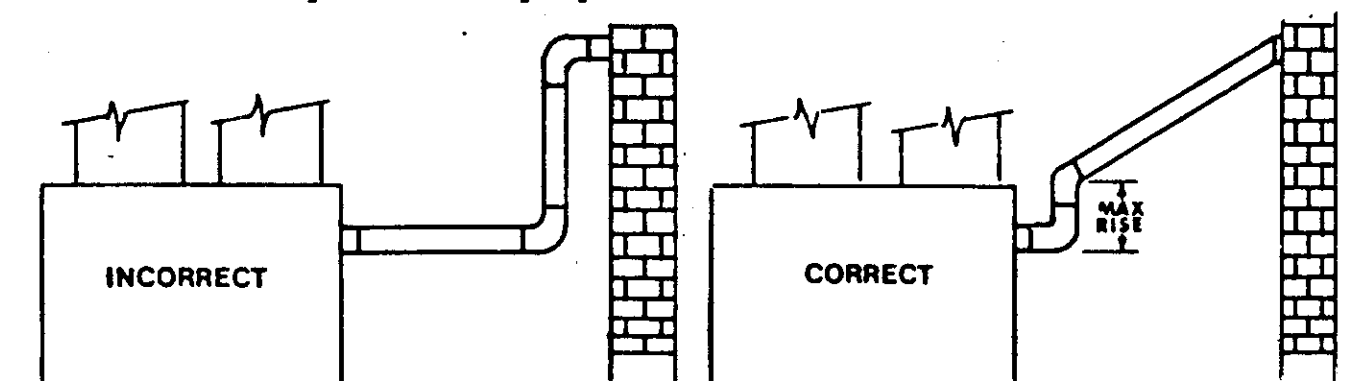

The flue pipe must not pass through a wall partition unless adequate protection is provided at the passageway. An acceptable passageway could be either an approved ventilated metal thimble, which is at least 12" larger in diameter than the flue or brick work at least 8" thick constructed into the wall and surrounding the flue pipe. (See Fig. A&B).

All installations and services must be performed by qualified service personnel.

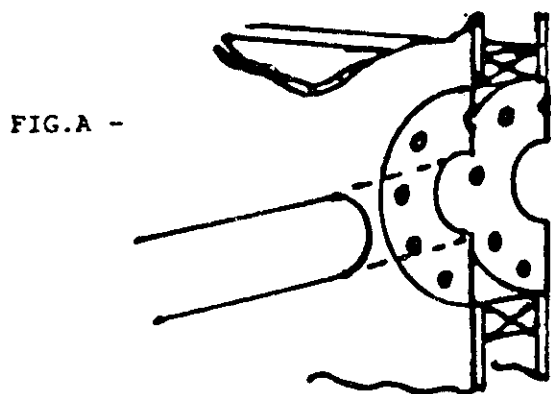
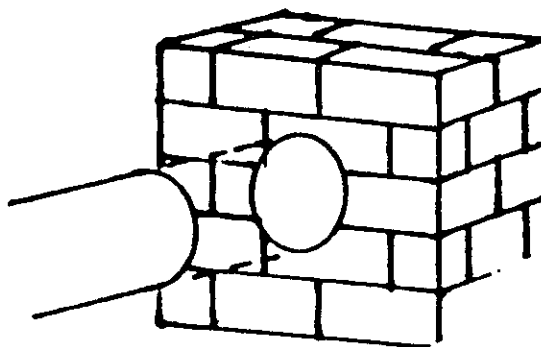

FIG.A -

VENTILATED
THIMBLE



- FIG.B -

FIRE PROOF
PASSAGEWAY

It is not recommended that the flue pipe be run through a cold wall or partition because the cold air mass may act as a restriction on the flue pipe causing poor draft.

VENTILATION FOR COMBUSTION AIR:

The WC/ furnaces may not be installed in a closet or alcove. The room in which the furnace is located must have a volume twelve (12) times the volume of the furnace.

If the WC/furnace is located in an unconfined space in a building of conventional frame, masonry, or metal construction with average window tightness and insulation, infiltration air normally is adequate to provide air for combustion and draft control operation.

If the WC/furnace is located in a building of unusually tight construction, as many new homes are, combustion air should be obtained from the outdoors or from spaces freely communicating with the outdoors.

To supply air from the outdoors, provide a permanent opening or openings, having a total free area of 28 sq. inches for WC/20, and 38 sq. inches for WC/ 27. Combustion air ductwork having a cross sectional area equal to the grill opening to which it is connected can be used to convey the make-up air from the outdoors to the furnace.

DUCTWORK:

The duct system should follow the design standards of Air Conditioning Contractors of America (ACCA) Manual D, or American Society of Heating, Refrigeration & Air Conditioning Engineers Inc. (ASHRAE) Latest Edition Fundamentals Volume. If power failures are a factor in the area, the duct system should be designed to offer the best possible gravity operation during power failure periods.

All installations and services must be performed by qualified service personnel.

In a companion furnace application, it is recommended that each unit be wired so as to have independent Fan & Limit control over each respective blower motor to thus provide separate blower operation. This will help assure proper air temperature delivery throughout the system when the demand for heat is being satisfied with only one furnace.

A minimum of 900 (Cubic Feet per Minute) for the WC/20 and 1300 CFM for the WC/27 is required when the WC/furnace is applied to an existing duct system. The desired dust system capacity for the WC/20 is 1000 CFM and for the WC/27 is 1500 CFM. When constructing a new duct system, the duct CFM capacity should equal the desired duct system CFM capacity specified above even if the house heat loss calculation dictates a duct system of lesser CFM capacity.

To achieve this air movement, the main trunk lines exiting the plenum must have the following square inch areas based on .10" Static Pressure (SP) loss on the supply systems.

DUCT SIZES FOR HOMES

VELOCITY APPROXIMATELY 800 FEET PER MINUTE

CFM	DIAM.	SQ. IN.	RECTANGULAR DUCT DIMENSIONS....INCHES							
45	4	12.5								
65	5	19.6								
100	6	28							6x6	9x4
150	7	38							8x6	12x4
200	8	50							10x6	14x4
250	9	63						8x8	12x6	18x4
300	9	63						9x8	14x6	20x4
400	10	78						12x8	16x6	25x4
500	12	113				10x10	14x8	19x6	30x4	
600	12	113				12x10	16x8	22x6	38x4	
700	12	113				14x10	18x8	26x6		
800	14	154			12x12	15x10	20x8	28x6		
900	14	154			14x12	17x10	22x8	32x6		
1000	16	201			15x12	18x10	24x8	36x6		
1100	16	201		14x14	16x12	20x10	26x8	40x6		
1200	16	201		15x14	17x12	22x10	28x8	42x6		
1300	16	201		16x14	18x12	22x10	30x8	46x6		
1400	18	255		16x14	19x12	24x10	32x8	48x6		
1500	18	255		17x14	20x12	26x10	34x8	50x6		
1600	18	255	16x16	18x14	22x12	26x10	36x8	54x6		
1700	18	255	17x16	20x14	22x12	28x10	38x8	58x6		
1800	18	255	18x16	20x14	24x12	30x10	40x8	62x6		
1900	20	314	18x16	22x14	26x12	32x10	44x8	64x6		
2000	20	314	20x16	22x14	26x12	34x10	46x8			
2200	20	314	18x18	20x16	24x14	28x12	36x10	48x8		

TO INSURE OBTAINING THE NECESSARY AIR HANDLING CAPACITY OF A DUCT SYSTEM EACH OF THE SYSTEM COMPONENTS (TRUNK LINES, TAKE-OFFS, RUNS AND REGISTER AND GRILL-FREE AREAS) MUST BE PROPERLY SIZED AND MATCHED TOGETHER. A 12X8 DUCT WITH A 400 CFM CAPACITY FOR EXAMPLE WILL NOT FLOW 400 CFM IF THE REGISTER(S) TO WHICH IT CONNECTS ONLY CAN FLOW A TOTAL OF 200 CFM.

All installations and services must be performed by qualified service personnel.

When sizing the return air duct system, the air handling capacity MUST BE EQUAL TO the supply system at a minimum. It is recommended to follow design parameters set down by ACCA or ASHRAE on the return air duct systems also.

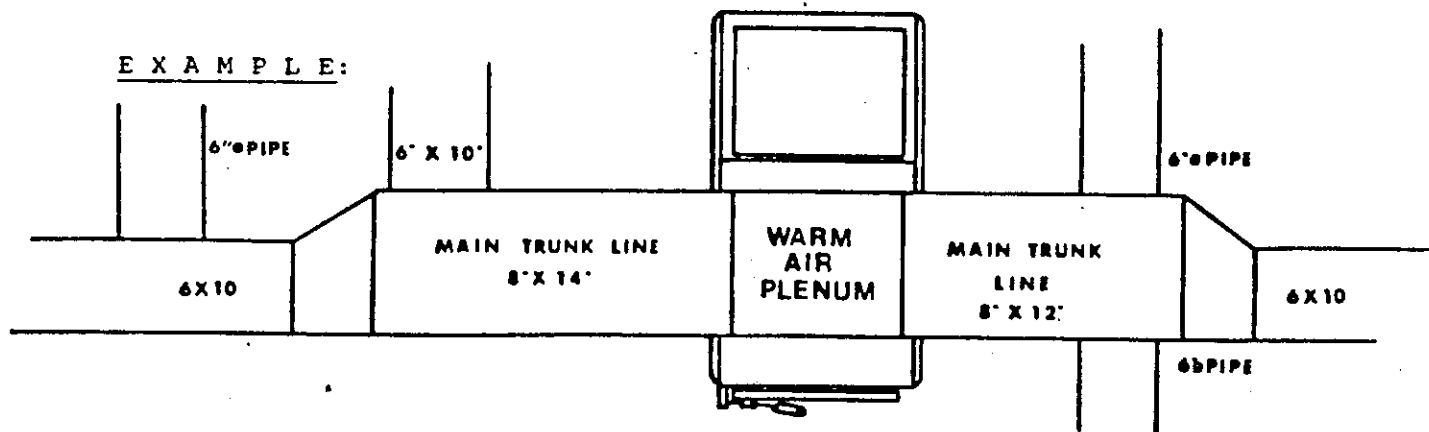

MAIN TRUNK	TAKE OFF'S
8x12 = 400 CFM	6x10 = 200 CFM
8x14 = 500	6x10 = 200
	6x10 = 200
<hr/>	60 = 100
900 CFM	60 = 100
	60 = 100
	<hr/>
	900 CFM

NOTE: Use register supplier catalog for proper sizing of outlet and return air registers to insure that the register will meet the CFM requirements of the run to which the register is connected.

When sizing the return air duct system, the air handling capacity MUST BE EQUAL TO the supply system at a minimum. It is recommended to follow design parameters set down by ACCA or ASHRAE on the return air duct systems also.

A plenum adapter kit is available to simplify the modification of a common warm air and return air plenum. The adapter can only be used when the WC/furnace is installed with a Thermo Pride Oil or Gas Companion Furnace. This kit is easily installed by sheet metal screwing it to the top of the furnaces.

NOTE: The companion installation can have the WC/Furnace on either side of the oil/gas furnace. (SEE ILLUSTRATION NEXT PAGE).

All installations and services must be performed by qualified service personnel.

PLENUM ADAPTER KIT ILLUSTRATION-

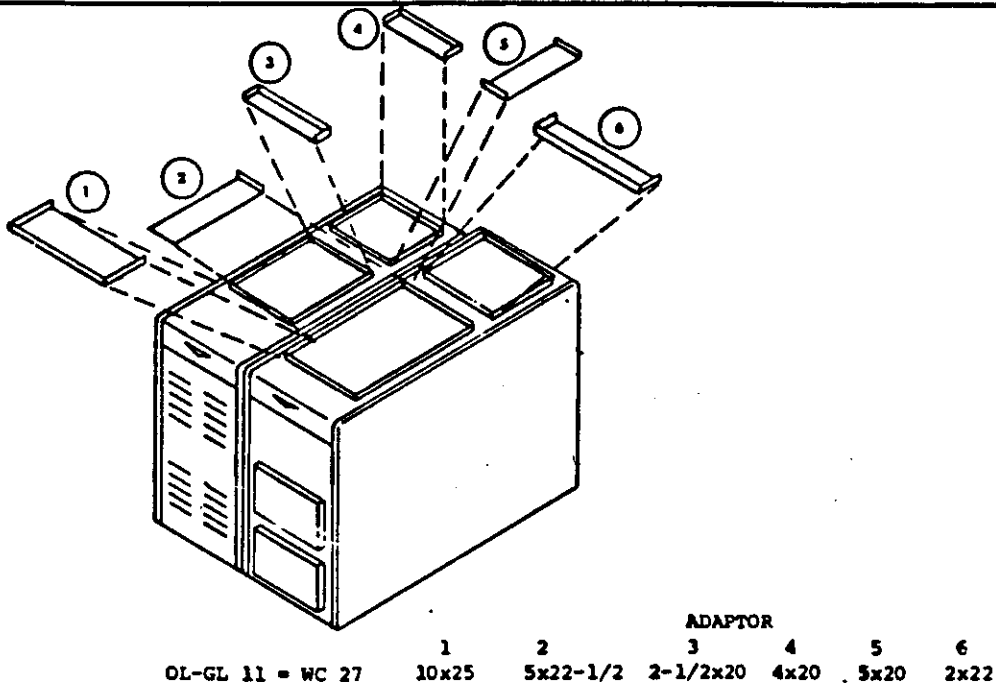
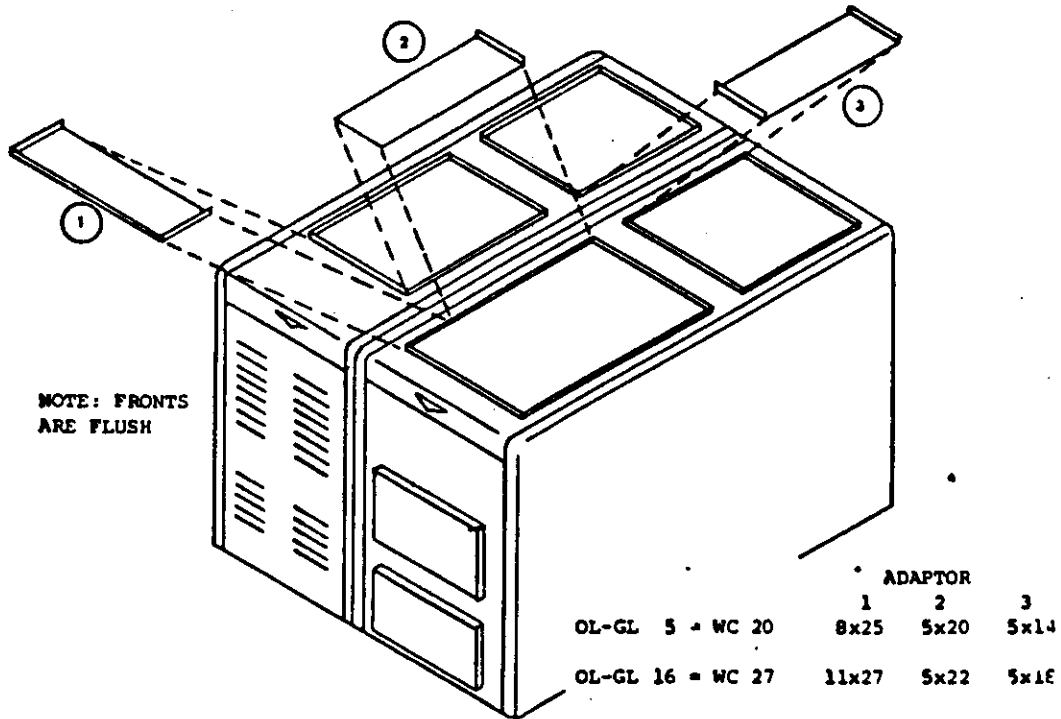

All installations and services must be performed by qualified service personnel.

FAN & LIMIT LOCATIONS-

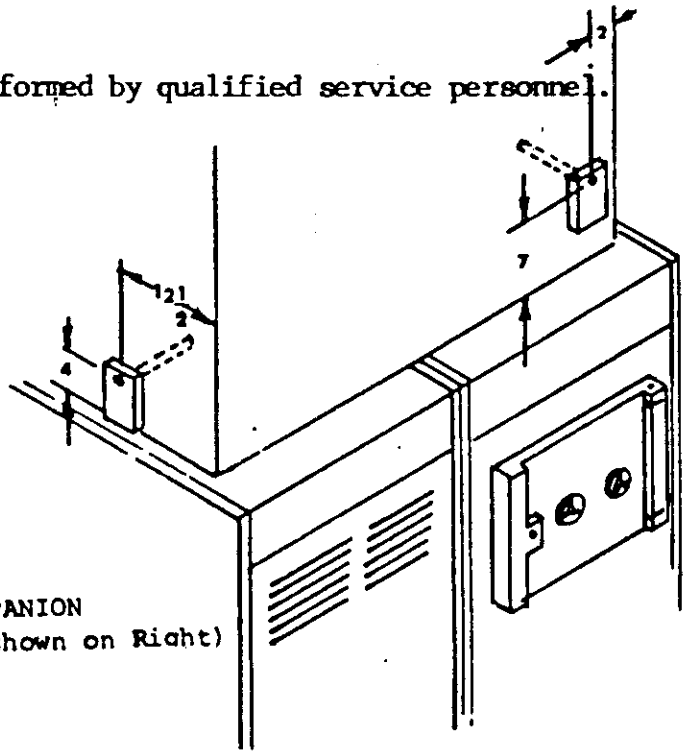
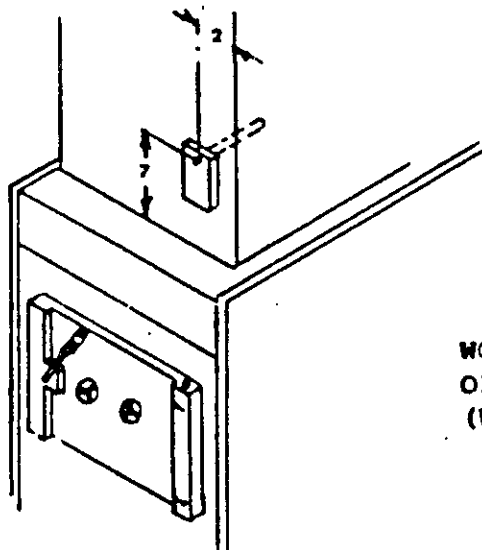

WOOD-COAL
OIL/GAS COMPANION
(Wood Coal shown on Right)

WOOD-COAL FURNACE ONLY

NOTE: The Fan & Limit may be located on the right or left side depending on which side the companion furnace is located.

A FEW ILLUSTRATIONS OF TYPICAL DUCT SYSTEMS
(WC & OIL/GAS FURNACE)

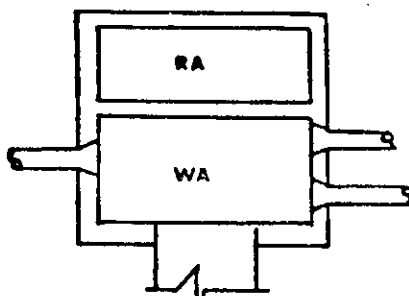

TRUNKLINE FRONT
RUNS L&R

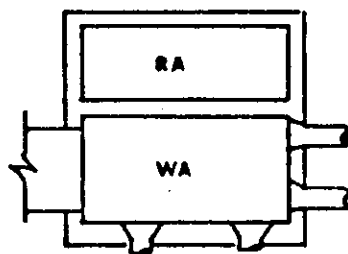

TRUNKLINE LEFT
RUNS FRONT & R

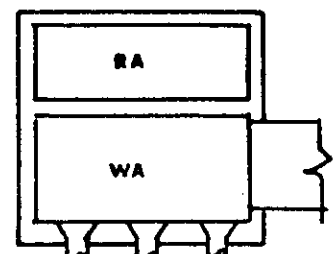

TRUNKLINE RIGHT
RUNS FRONT ONLY

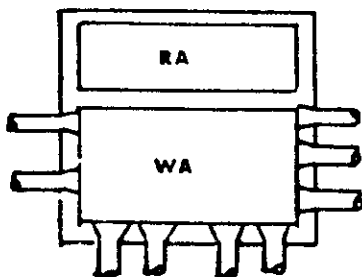

ALL INDIVIDUAL RUNS

When connecting duct work to a WC - Gas/Oil unit installed, under a common warm air and common return air plenum, the duct system should be designed in the same manner as a single furnace system. The furnaces are wired independently and each blower operates only when there is heat available. The common plenum is pressurized with heated air and will deliver uniformly in all directions.

NOTE: When a return air register is located in the same room as the WC/Furnace, the register should be at least 20' away from the wood/coal furnace.

All installations and services must be performed by qualified service personnel.

WARNING.....The WC/Furnace must be installed with 90% of the outlet supply registers at least 1' higher in an upward direction than the height of the outlet plenum of the furnaces. This will aid in gravity flow of heat away from the furnace in periods of power outages. It is not recommended to try and force the warm air downward below the level of the height of the outlet plenum.

If the existing oil/gas furnace in the home does not require replacement, the wood/coal unit may very readily connect into the existing duct system as follows:

- A) Set wood/coal unit in the most practical location parallel to the existing oil/gas unit with 18" between the furnaces.
- B) Construct the largest size possible cross-over duct. Cut plenums and connect cross-over duct to each plenum.
- C) Repeat for the return air plenum.
- D) Do not modify the wiring or control locations on the existing oil/gas furnace.
- E) Wire the wood/coal unit, as shown on Page 23, and install the fan-limit control, as shown on Page 16.

The cross-over duct permits air from the wood/coal unit (when operating) to enter the original furnace plenum and be properly distributed throughout the original furnace plenum and throughout the original duct system. The minimum size for the cross-over duct for the WC/20 is 201 sq. inches, and for the WC/27 it is 314 sq. inches. However, it is recommended that the cross-over be as large as the plenum size that the existing furnace will permit (Step B) so the least restriction to air flow exists.

All installations and services must be performed by qualified service personnel.

The following sketch shows a typical basement model oil/gas furnace cross connected to a wood/coal unit (wood/coal may be on the left or right side). If ductwork is already connected to the existing furnace plenum on the side the cross-over duct is to be connected, simply modify this duct and reconnect it to the wood/coal plenum. (See illustration at bottom of page).

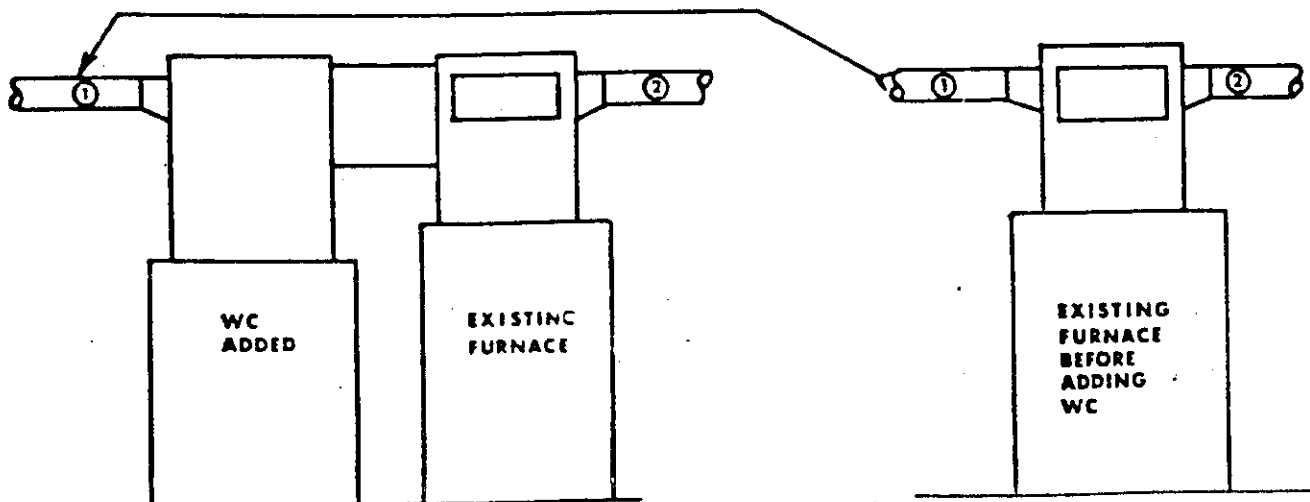
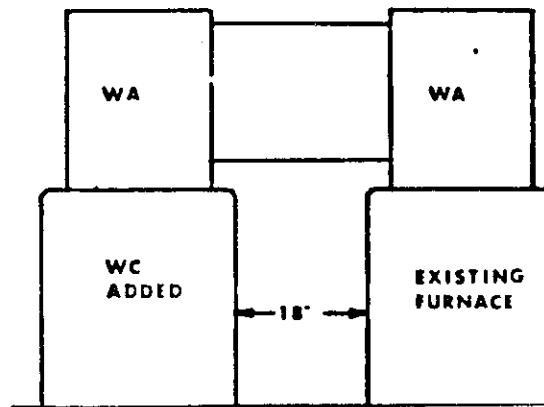
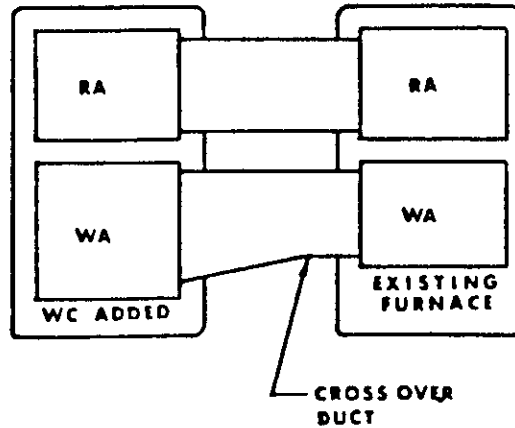

All installations and services must be performed by qualified service personnel.

INSTALLATION OF AN INDOOR (AIR CONDITIONING OR HEAT PUMP) COIL -

If an indoor coil is added to a system involving a wood/coal unit, the following guidelines are offered:

A) If a wood/coal and another furnace is ducted together either under a common plenum or using a cross-over, the indoor AE (A-shaped) coil must be installed over the supplementary furnace NOT the wood/coal.

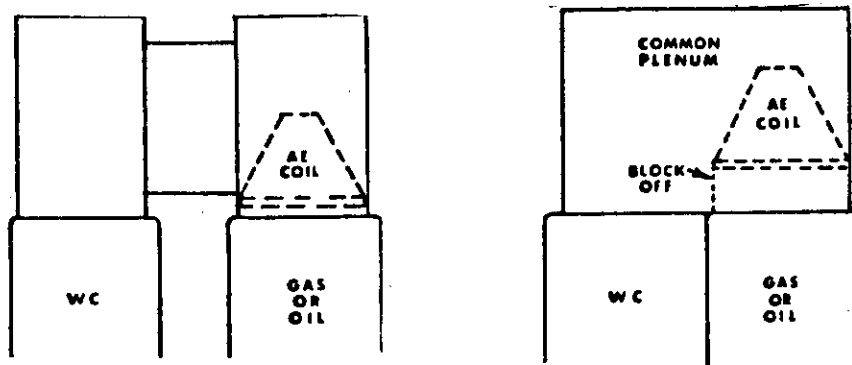

When installing the indoor AE coil over the oil/gas furnace, construct the necessary block-off inside the plenum to make certain that all air from the oil/gas blower passes through the AE coil.

B) If an indoor coil is to be added to the WC/Furnace only, a horizontal (HE) slab type coil must be installed in the trunkline downstream from the wood/coal furnace.

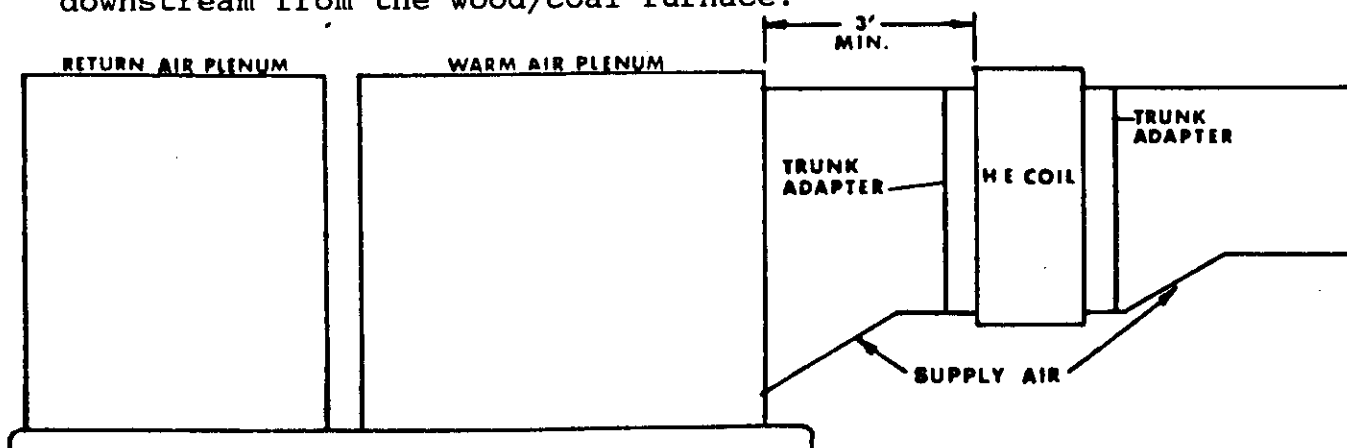

When the HE coil is mounted in the trunk, full size trunk adaptors into and out of the coil must be constructed. After the outlet adapter, the supply truck may be reduced to size desired. The HE coil fin area should be a minimum of 3' downstream from the WC/Furnace warm air plenum.

NOTE: All (100%) of the air supply must pass through the HE coil for proper cooling.

All installations and services must be performed by qualified service personnel.

WARNING: An AE Coil cannot be mounted immediately over the warm air outlet of the WC/Furnace because the coil is too restrictive on the air flow. Also, radiant heat from the WC/Furnace may become too excessive and cause damage to the expansion valve and coil.

It is not recommended to install an AE coil on the return air side of any furnace, due to the possibility of condensate forming inside the furnace. This could cause excessive rust and deterioration of the heat exchanger. Such an installation will void the warranty on the Thermo Pride furnace heat exchanger.

INSTALLATION OF TWO PIECE DOOR HANDLE:

These door handles are designed to be field installed easily and quickly. These handles are also adjustable to compensate for any wear that might occur. This enables the homeowner to keep the door handle at the proper position when it is completely latched. **NOTE:** When the door is latched tightly, the wooden handle should not be directly in front of the heat which radiates out of the over-fire air ports. This may cause the wooden handle to dry and crack. (See Illustration Below).

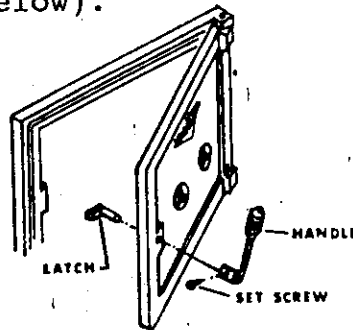

To install the door handles, follow these steps:

- 1) Place the latch through the door into the handle.
- 2) Tighten the bolt (set screw) taking care that the bolt is in line with the flat, which is on the rod portion of the latch.
- 3) Close and latch the door tightly pulling the door snugly against the rope gasketing. Check the position of the handle. If it is between the 1:00 and 2:00 o'clock position, it should not be exposed to excess heat nor will the handle ever fall backwards and become unlatched. (See illustration below).

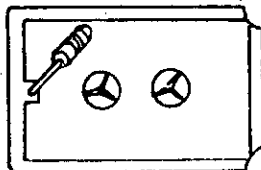

All installations and services must be performed by qualified service personnel.

DAMPER MOTOR INSTALLATION:

Supplied with the wood/coal furnace is a damper motor, barocek draft regulator, transformer, thermostat and (4) pulleys with chain. These items allow the thermostat to automatically vary the burning intensity of the fuel and thus create more heat when needed.

When the thermostat is not calling for heat, or the furnace is in a checked position, the damper door is closed and the barocek draft regulator is held approximately 1/3 - 2/3 open. The effect of these settings is that extra air needed for the chimney draft will go thru the draft regulator rather than through the furnace. When the thermostat calls for heat, the damper motor pulls the damper door open and lets the barocek swing free in turn maintaining the desired maximum draft through the furnace, thus increasing the burning rate.

INSTALL THE ABOVE ITEMS AS FOLLOWS:

1. Mount damper motor near the ceiling on either side of the wood/coal furnace.

a) Secure the crank arm to the damper motor with screw and spacer provided. (See Illustration Below).

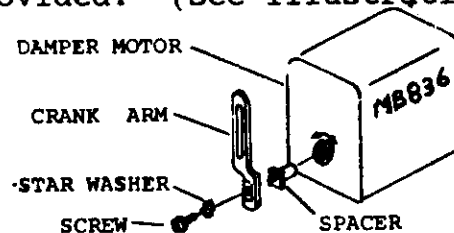

b) Mount the damper motor on the mounting bracket with two (2) 10/24 x 1/2 screws provided, and then mount to the ceiling.

2. Position the (4) pulleys provided, as shown on next page, with one pulley directly above the damper door eye and one in line with the damper motor arm and at 90° to the pulley over the damper door. Mount the third pulley directly over the barocek draft regulator in the flue pipe. Place the fourth pulley in line with the damper motor arm at 90° to the one over the barocek draft regulator.

3. Connect the chain, as shown on page. **NOTE:** When damper motor is in the OFF or CLOSED position, the damper door must be closed completely and the barocek draft regulator held approximately 1/3 - 2/3 open, as stated in the instructions provided with the draft regulator. When the damper motor is energized by the thermostat, the damper door opens and the barocek swings free.

All installations and services must be performed by qualified service personnel.

Install the thermostat in a central location of the home in the natural circulating path of room air. The thermostat should not be exposed to cold air infiltrations from the drafts created by windows and doors. The thermostat should also not be exposed to heat from nearby fireplaces, appliances, lamps, registers and rays of the sun. The hole in the wall through which the wires from the thermostat run should be adequately sealed to prevent drafts from affecting the thermostat.

If less than a full open damper door position is desired when the thermostat calls for heat or less than a full open draft regulator position is desired when the thermostat is not calling for heat, some slack may be left in the chain at the appropriate end or both ends. The exact adjustment of the chain will depend on conditions unique to each installation. Variables such as fuel, the average time the thermostat calls for heat and the actual installation itself will vary the adjustments needed in the chain to achieve the desired performance of the wood and coal furnace. Experimentation will be necessary to find the settings most effective for each situation.

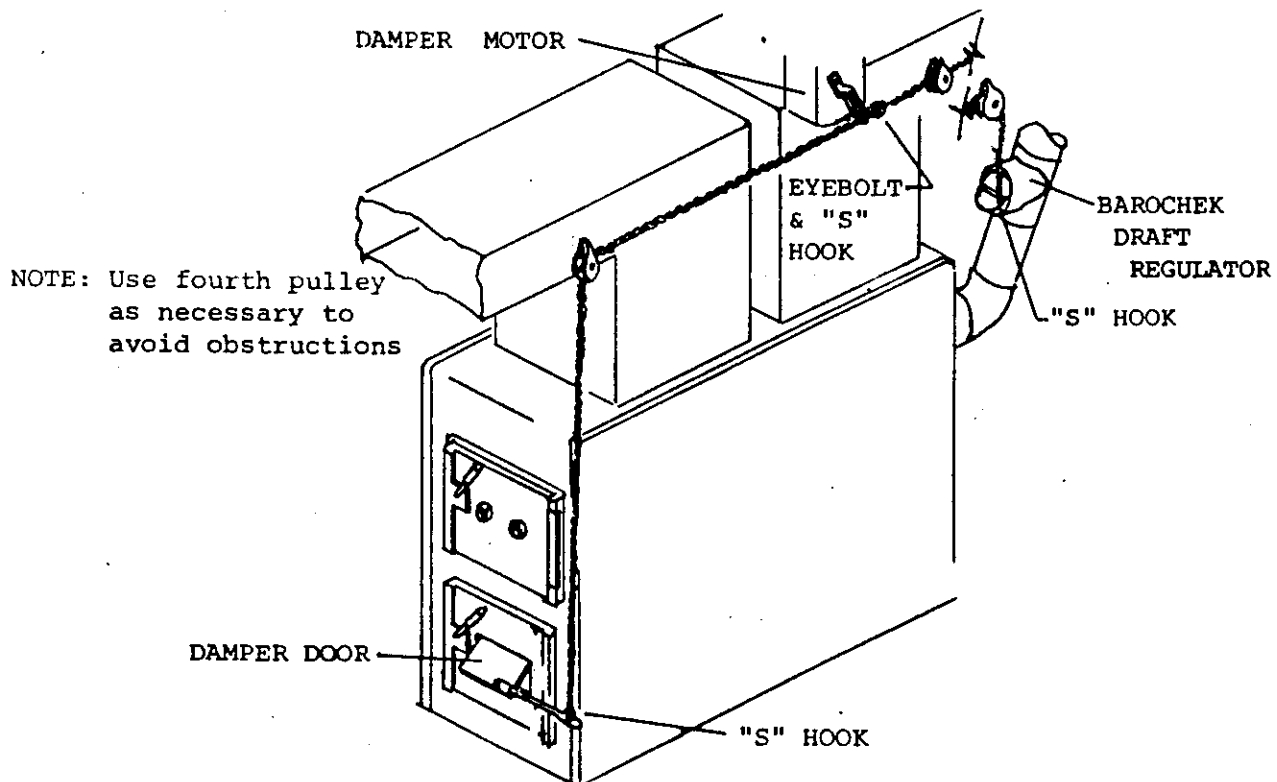

All installations and services must be performed by qualified service personnel.

WIRING DIAGRAM WOOD / COAL FURNACE

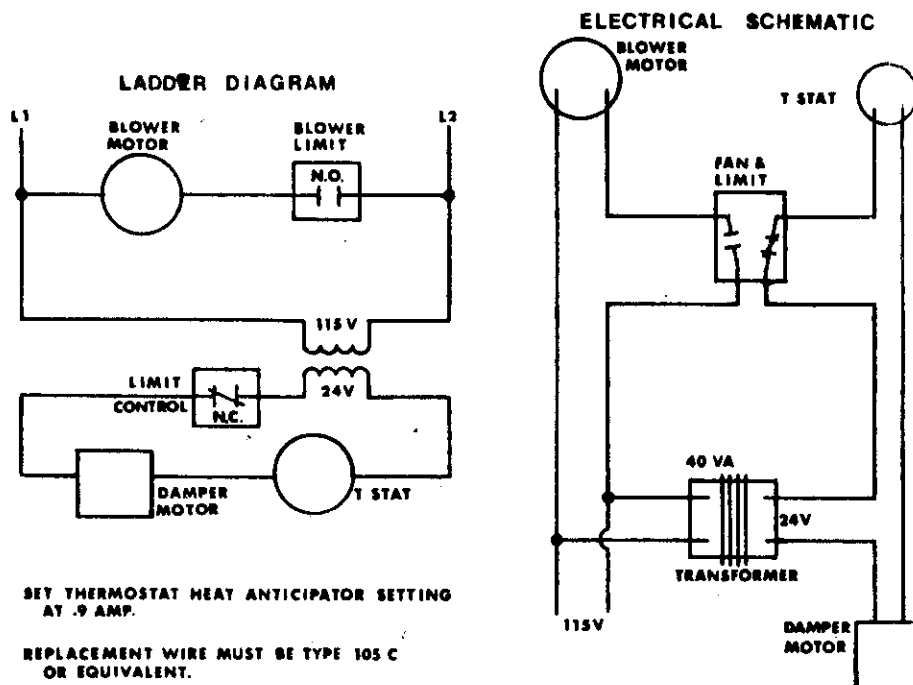

REMOVE TAB TO SEPARATE LOW VOLTAGE FROM HIGH VOLTAGE ON FAN & LIMIT CONNECTIONS

WIRING: The WC Furnace and companion furnace are wired independently of each other. The above wiring diagram for the WC Furnace depicts the recommended wiring hook-up. The companion gas or oil furnace should remain wired as specified by the manufacturer.

In order, set the heat anticipator exactly - it is necessary to measure the milli-ampere in the 24 volt system. To do this, remove the thermostat from the sub-base on the wall and connect a milli-amp meter to terminals on the sub-base. Adjust the heat anticipator to the reading on the milli-amp meter.

NOTE: All wiring must conform to the provisions of local codes or, in the absence of local codes, with the provisions of the National Electric Code (Latest Edition).

WOOD / COAL DIRECT DRIVE MOTOR AND BLOWER SPECIFICATIONS

When installing a replacement motor or adding air conditioning to the existing systems the following information should be considered. Please note: the motor speeds may need to be changed to complement the amount of air conditioning to be installed (400 CFM per ton).

MODEL NO.	W/C 20	W/C 27
H.P. OF 4 SPEED MOTOR (AT HIGH SPEED)	1/2	3/4
A.C. VOLTAGE	115	115
RPMS AT HIGH SPEED	1075	1075
RUN CAPACITOR	5 μ F	5 μ F
ROTATION (SHAFT END)	CLOCKWISE	CLOCKWISE
SHAFT DIAMETER:LENGTH	1/2 : 6	1/2 : 6
MOTOR DIAMETER:HEIGHT	5-5/8:5 -3/8	5-5/8:5-5/16
FULL LOAD AMPS	7.7	11.8
CFM@.2" & .5" W.C. STATIC PRESSURE	.2 .5	.2 .5
@ HI-SPEED	1625 1310	2120 1920
@ MH-SPEED	1500 1215	1975 1750
@ ML-SPEED	1250 1000	1850 1710
@ LO-SPEED	1175 800	1640 1510
BLOWER SIZE	10-9 DD	12-9 DD

The wire leads from the blower motor are color coded as follows:

	UNIVERSAL	EMERSON
Low -	red	purple
Med.Low-	blue	red
Med.High-	yellow	blue
High-	black	black
Common-	white	white
Capacitor-	brown	brown

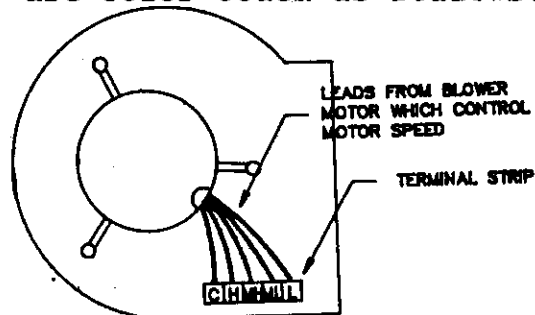

When connecting or changing blower speeds, it is necessary to TURN OFF INCOMING POWER FIRST. Next, find the system static pressure and the desired CFM and match it to the appropriate speed form the above table. Then connect the blue lead to the speed whcih matches the desired CFM. Restore incoming power.

All installations and services must be performed by qualified service personnel.

FURNACE DISASSEMBLY INSTRUCTIONS- (If Necessary) :

1. Uncarton unit and remove all controls from inside of unit.
2. Remove blower access door and set aside. Remove filter and filter rack from unit.
3. Remove the screws that fasten the rear trim panel casing from around the flue plate. The rear trim panel can now be removed.

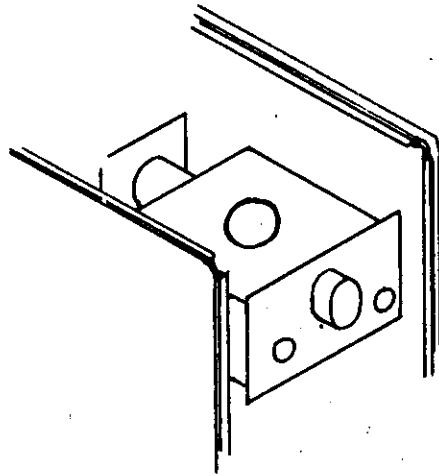

4. Remove the door frames from the front of the unit by removing the self tapping screws around the frame edges.
5. The front trim panel can now be removed from the unit.
6. Remove the screws from both casing top panels and lift panels from unit.
7. Before the casing sides can be removed, you must remove the two screws that secure the rear separator panel to the casings. The casings can now be removed.
8. Remove blower from unit.
9. With someone holding the radiator so it will not drop, remove the (8) eight 5/16" nuts that fasten the radiator to the heat exchanger. Remove base hold down bolts on heat exchanger and the unit is now ready to be moved.
10. Reverse procedure when reassembling.

All installations and services must be performed by qualified service personnel.

REFRACTORY REPLACEMENT:

It is not uncommon for cracks to appear in the refractory in normal service. A crack in the refractory will cause no problem or damage to the heat exchanger. Only when a crack enlarges to the point that metal can be clearly seen through the crack, or when a piece of refractory falls out of place, should the refractory be replaced. There are several acceptable types of refractory patching material available on the market at fireplace shops or hardware stores which may be used to repair cracking.

NOTE: The refractory will need to be replaced periodically, depending on the firing rate, type of fuel, and fuel loading techniques.

REPLACEMENT PROCEDURE:

1. Remove all loose parts from heat exchanger.
2. Install bottom retainer (as illustrated below).

(Place base plate under bottom retainer on WC/27 ONLY.)

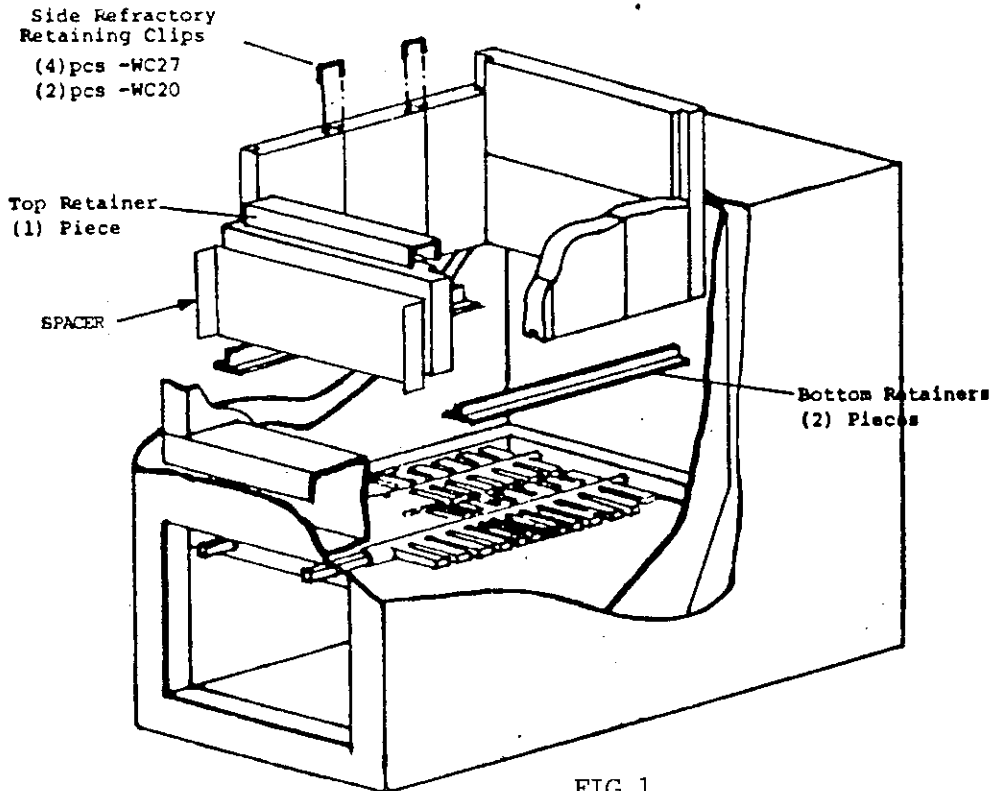

FIG.1
(WC/27 SHOWN)

All installations and services must be performed by qualified service personnel.

PLEASE NOTE: Due to the + or - tolerance on refractory material, the respective brick may be shorter than the dimensions shown in this manual. After assembly, this shortage may result in an accumulated 1" gap at the corners. The refractory brick should be separated so that this gap is evenly distributed between the side and end refractory.

The dimensions of the PB#1 Refractory are as shown:

NOTE: End bricks at rear are two high.

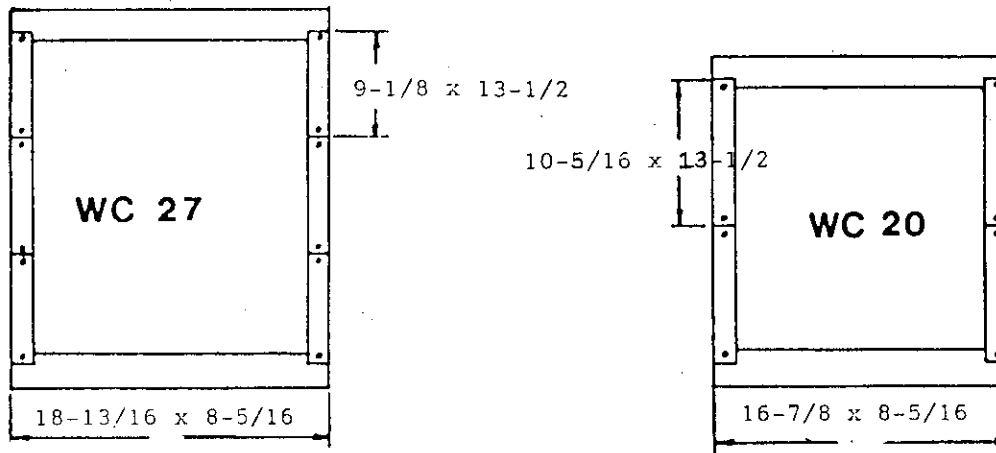

1. Place the front and rear PB#1 refractory into place first, as illustrated in Figure 2. The inside corners of these refractories are notched to offer support to the side refractory. This will prevent side refractory from falling inward.

2. Place the bottom retainers on the sides of the fire box at grate level. These "T" shaped retainers fit into a groove on the bottom of the side PB#1 refractory and secure the refractory from sliding inward.

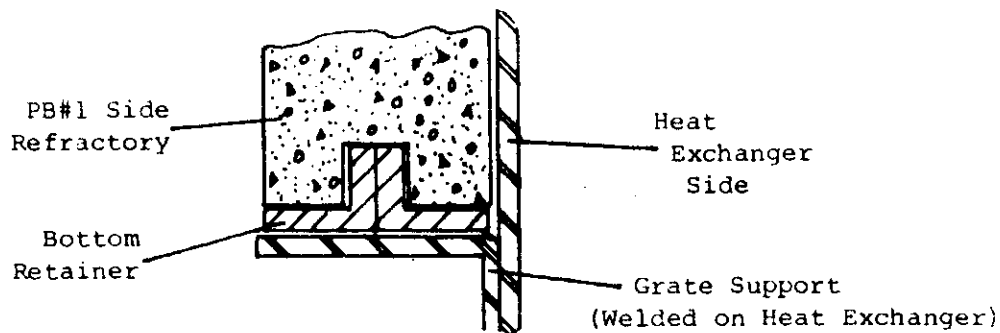

3. Put the top retainer provided over the front refractory. This is to avoid excessive wear from logs that are pushed into the fire box.

All installations and services must be performed by qualified service personnel.

4. Slide the retaining clips into the 1/4" holes on the top of the side refractory. The clips interlock two side bricks together to prevent movement.

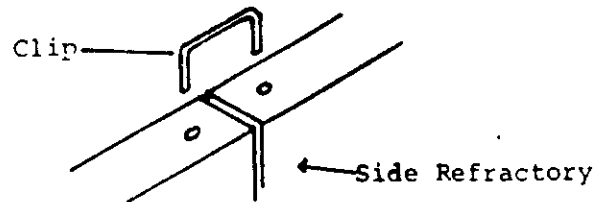

The clips prevent the side refractory from falling in toward the center of the fire box.

O P E R A T I O N

DO'S AND DONT'S

The most important item to remember when building a fire in the wood/coal furnace is to never use a combustible liquid - such as; gas, kerosene, or charcoal lighter to start or "freshen-up" a fire in the furnace. DO NOT burn garbage, gasoline, naphtha, engine oil or any other fuel not approved with this unit. Before you start the fire, safety check the room thoroughly for combustible material or liquids and for adequate ventilation. The fuels for which the WC/20 and WC/27 are designed are wood and coal. Railroad ties, fence posts, or other chemically treated woods are not acceptable fuel.

During storage, and while in transit, it is possible that moisture may have been absorbed by refractory. Also, if the shipment is made during the cold months of the year, the refractory will become extremely cold. To avoid thermal-shock and to dry the refractory thoroughly, the initial fire must be very small.

The initial fire should be about 8" in diameter and centered in the middle of the grate area. This fire should be maintained at low point until the steel heat exchanger outside the refractory area and the outlet plenum are warm to the touch. If a large roaring fire is made initially, the refractory may crack severely, due to thermal shock.

WARNING: Never operate the wood/coal furnace with the feed door or ashpit door open any amount. The doors must be completely closed and latched.

All installations and services must be performed by qualified service personnel.

LIGHTING PROCEDURES:

- 1) Place a small amount of crumpled paper on the grates and cover with a few small sticks of wood fuel or a small amount of coal, depending upon principle fuel desired.
- 2) Prop open the underfire damper located on the ashpit door. (See Illustration below).

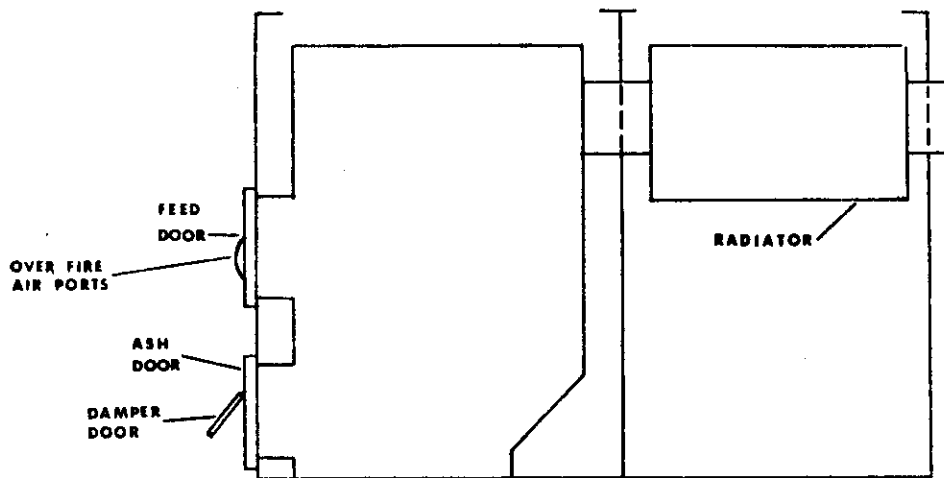

3) Ignite the paper. Once the draft is established, larger pieces of wood or more coal can be added to the fire. Readjust underfire damper so it can function automatically under control of the damper motor.

4) If the smoke puffs out into the basement, a possible solution at start up would be to ignite several pieces of crumpled paper placed on the top of the pile of kindling at the same time the paper on the bottom of the pile is ignited. The paper on top will burn quite furiously and with a large flame, thus warming the chimney enough to start a draft.

NOTE: Even with a well established fire and chimney draft, it is possible on extremely gusty days that chimney down draft may occur, thus forcing small amounts of smoke into the basement through either the barochek draft regulator or the air adjustments in the feed or ashpit door.

5) The over-fire air ports in the feed door must be regulated to the needs of the fire and the type fuel being burned.

Wet wood, while not recommended, will require the over-fire air ports to be closed. A chimney draft of .04" to .06" water column is optimal.

All installations and services must be performed by qualified service personnel.

POWER FAILURE:

In the event of a power failure when the furnace is in operation, special precautions must be observed to insure against overheating. Combustion air must be reduced or shut off completely, depending upon the size of fire actively burning. All heat gained from the furnace will dissipate through gravity flow. To achieve gravity flow, follow these steps:

- 1) All manual dampers in the supply and return ductwork must be fully opened.
- 2) All floor and wall registers must be opened.
- 3) Remove the furnace blower access door to provide a supply of cool air into the furnace. (Depending on the intensity of the existing fire and anticipated length of the power failure, the blower can be disconnected and removed from the furnace (or slid back) to allow more air flow). If the power outage extends for a substantial length of time, the furnace could be charged with small amounts of wood and coal at frequent intervals. The operation of continued burning power failure conditions should be done with care to avoid overheating and causing damage to the furnace.
- 4) The underfire damper and overfire air ports should be closed completely to reduce the intensity of the fire quickly. If the power failure persists indefinitely, the overfire air ports can be opened up to keep the fire burning at a low intensity level.

F U E L

COAL:

There are several grades of coal which may be available or selected by the home owner as fuel. Burning qualities will vary from grade to grade so no set rules apply. There are certain factors which are common to all grades of coal. The coal should be as clean as possible containing no dust, slack or fines. These impurities will cause the coal to burn inefficiently and incompletely. Slack is an impurity which will not burn. Dust, or fines, are so small that they will pack tightly around the coal preventing an adequate supply of combustion air from surrounding the coal. For these reasons, washed coal is recommended.

The recommended size for bituminous coal is approximately 3" to 6" in diameter. For anthracite coal, a smaller size is recommended which is approximately 1" to 2 1/2" in diameter. Any type coal which is less than 1" in diameter may fall through the open areas of the grates.

All installations and services must be performed by qualified service personnel.

Unlike wood, which requires nearly all the combustion air overfire, coal requires approximately 50% overfire and 50% underfire. Consequently, the damper chain should be a few links shorter in the "no call for heat" mode to allow underfire air at all times. Thus, when the thermostat demands heat, the damper will open completely and then close to a partially open position upon satisfaction.

Several other "rules" applicable to coal firing are as follows:

A) Once a burning coal bed is well established, allow the unit to operate under automatic control. Shorten or lengthen the damper chain to obtain the most satisfactory constant underfire draft.

B) Do not "overshake" the grates. Normally, twice a day will be sufficient. Shake gently to remove ashes only. Do not shake hot coals through the grates - this causes a waste of fuel.

C) After shaking, remove the ashes from the ashpit. Underfire air volume will be reduced if ashes accumulate. In addition, ashes allowed to build-up to the bottom of the grates may damage the grates by not allowing air (for cooling purposes) to circulate under the grates thus, in effect, cooking the grates until they fail.

D) Clinkers, a caking or fused non-combustible mass, accumulating on the top-side of the grates prevents proper combustion air from entering the coal bed and may also cause damage to the grates. Remove clinkers from the topside of grates as they build up-do not attempt to shake clinkers into the ashpit as live coals will likely shake through also.

E) Before fresh coal is added to a hot coal bed, the under-fire damper should be opened. After adding new coal, the fire should be allowed to burn freely until combustible gases from the new charge are burned off. The under-fire damper may then be closed to its' original position. The thermostat will maintain home temperature control automatically thereafter.

When adding fresh coal to an existing fire, you should never completely cover the existing bed of burning coal. If the burning coal is completely covered with fresh coal, a pocket of volatile gases may build up and ignite causing smoke and gases to puff out the front of the furnace. To avoid this problem, fresh coal can be banked on the sides or the front and rear of the fire box leaving some of the burning coal exposed.

All installations and services must be performed by qualified service personnel.

The homeowner will determine, over a period of time, the most satisfactory adjustment of overfire air (shutters in the fire door) and underfire air (shortening chain linkage) for the particular coal being used. Once the adjustment level is determined, further changes should not be necessary for that particular grade of fuel.

COAL:(CONTINUED)

<u>VARIOUS TYPES OF COAL</u>	<u>APPROXIMATE BTU/LB.</u>
Anthracite	12,700
Semi-Anthracite	13,600
Low-Volatile Bituminous	14,350
Medium -Volatile Bituminous	14,000
High-Volatile Bituminous A	13,800
High-Volatile Bituminous B	12,500
High-Volatile Bituminous C	11,000
Sub-Bituminous B	9,000
Sub-Bituminous C	8,500
Lignite	6,900

CHARACTERISTICS:

Anthracite: is clean, dense, hard coal which creates little dust. It is hard to ignite, non-caking, burns uniformly and is relatively smokeless with a short flame.

Semi-anthracite: is also hard, but has a higher volatile content than anthracite. It ignites somewhat more easily and is otherwise very similar to anthracite.

Semi-bituminous: is soft, friable and creates fines and dust when handling. Ignites slowly, burns with medium flame, and caking increases as the volatile matter increases.

Bituminous: ignites easily, burns freely and creates more smoke and caking as the volatile matter increases.

Lignite: is of a woody structure, disintegrates as it dries, low heating value, burns easily and creates little smoke or soot.

SPECIAL INSTRUCTIONS:

All installations and services must be performed by qualified service personnel.

When adding coal to a wood/coal unit, make certain the coal level is not above the level of the bottom of feed door. The purpose of the refractory is to protect the heat exchanger metal from excessive temperatures, which could eventually burn out the steel. If the coal is consistently piled above the refractory level, the heat exchanger will predictably be distorted by excessive temperatures and failure will occur. Firing at a rate which produces distortion of the steel, due to an excessive coal level, automatically VOIDS the warranty on the heat exchanger.

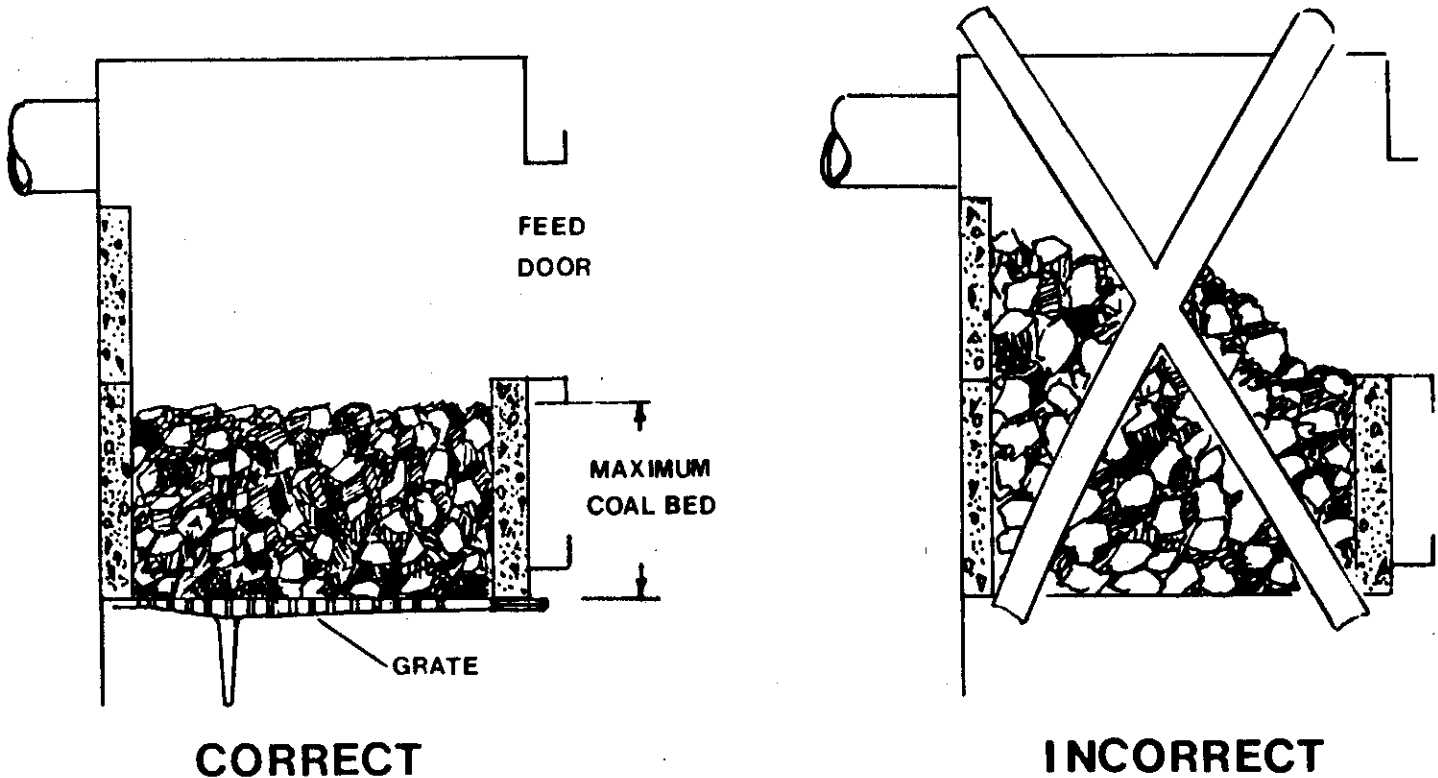

WOOD

Firewood is divided into two general categories - HARDWOODS and SOFTWOODS. Hardwoods are obtained from broad-leaved trees-softwoods form trees with needle-like or scaly leaves.

The variety of wood burned can make a large difference in the amount of burn time. The denser hardwoods - such as; hickory, oak and apple will give the longest burn time, while the least dense woods such as; pine, poplar and birch will burn for the shortest periods of time. Moisture content will also effect the burn time, but burning wet or green wood will decrease the heat output and also will increase the creosote problems so this is generally not advised. The diameter of the wood burned has a marked effect on the total burn time.

Each particular species of wood has its' own unique characteristics. To select the most suitable local seasoned wood, refer to the following Table-

RATINGS FOR FIREWOOD -TREES-	Relative Amount Of Heat	Is It Easy To Burn?	Is It Easy To Split?	Does It Pop Or Throw Sparks?	Does It Have Heavy Smoke?	General Rating and Remarks
Ash, red oak, white oak, beech, birch, hickory, hard maple, pecan, dogwood	high	yes	yes	no	no	excellent
Soft maple, cherry, walnut	medium	yes	yes	no	no	good
Elm, sycamore, gum	medium	medium	no	no	medium	fair- contains too much water when green
Aspen, basswood, cottonwood	low	yes	yes	no	medium	fair, but good for kindling
Chestnut, yellow popular	low	yes	yes	yes	medium	poor
Southern yellow pine, Douglas fir	high	yes	yes	no	yes	good, but smokey
Cypress, redwood	medium	medium	yes	no	medium	fair
White cedar, western red cedar, eastern red cedar	medium	yes	yes	yes	medium	good- excellent for kindling
Eastern & western pine, white pine, sugar pine, ponderosa pine, true firs	low	medium	yes	no	medium	Fair-good kindling
Tamarack, larch	medium	yes	yes	yes	medium	fair
Spruce	low	yes	yes	yes	medium	poor

All installations and services must be performed by qualified service personnel.

Wood that is small in diameter, or finely split, will burn for much shorter periods of time than larger pieces. People getting the longest burn time seem to generally use wood six to eight inches in diameter to achieve their long burns and they are very careful to load the furnace so that the maximum number of these larger logs are used within the limits of the combustion chamber. They are also careful to insure that all logs are parallel to each other and none are cocked horizontally or vertically, as these conditions do shorten the burn time.

Hardwoods and softwoods burn differently. The softwoods contain more volatile gases. They are easy to ignite and burn with more flame. But softwoods may also produce more creosote. Softwoods generally have more heating value by volume. Because of the difference in characteristics, softwoods are often preferred for starting a fire, and hardwoods are preferred for maintaining a fire.

STORAGE OF FUEL

Here is the best way to store wood while it is being seasoned. Stack the wood loosely, with the ends exposed and the bark on top. It is best to pile the wood in an area with low humidity and good air circulation. If you locate your pile outside, select a spot with a lot of sunshine. Pile the wood on top of skids or otherwise keep it off the ground. Line up the pile so the ends of the logs face directly into the prevailing winds. Make sure there is good drainage. A hillside is preferred. Cover the top of the pile only with a waterproof tarp and anchor it securely. If your pile is stacked over 4' high, you may want to brace it. Use the oldest wood first....before it rots..Incidentally, you can tell if the wood is properly seasoned by hitting two pieces together. You should hear a hollow ringing sound. However, frozen green wood will also make this sound. To distinguish green wood from seasoned wood, look at the ends. Seasoned wood will have cracks in the end running through the annual rings. A green log will not have any splits in the end. Bark separation, or peeling off the wood is another good indication of adequate seasoning.

Green wood contains a high percentage of water. It may be as much as half water by weight. For this reason, green wood does not burn well. We strongly recommend that you air dry or "season" all of your fire wood. The seasoning process takes from four months to a year to complete. Less drying time is required if you split your logs, stack them loosely, and store them in a well ventilated and dry area. It is wise to cut your wood well in advance. It is recommended that wood with a moisture content of 17% or less be burned.

All installations and services must be performed by qualified service personnel.

MAINTENANCE

ASH REMOVAL

Open the ashpit door periodically to check the level of ash accumulation. The ash level should never accumulate closer than 3" below the bottom of the grates. When ash removal is necessary, leave a half inch layer of ashes in the bottom of the ashpit area. These ashes will act as an insulator and reflect heat up into the fire. BUT REMEMBER, ashes allowed to build up to the bottom of the grates may damage the grates by not allowing air (for cooling purposes) to circulate under the grates thus, in effect, cooking the grates until they fail. Excessive ash will also prevent adequate underfire combustion air from being introduced. Ashes should be placed in a metal container with a tight fitting lid. The closed container of ashes should be placed on a non-combustible floor or on the ground well away from all combustible materials pending final disposal. If the ashes are disposed of by burial in soil, or otherwise locally dispersed, they should be retained in the closed container until all cinders have thoroughly cooled.

The grates should not be shaken as often (or not at all) when burning a wood fire. A wood fire does not require a large amount of underfire air, thus if the ashes are allowed to build up on top of the grates the fire will burn with somewhat less intensity. Less heat will be lost through the heat exchanger to your home.

REGULAR MAINTENANCE

Your wood/coal furnace will require cleaning more frequently than an oil or gas furnace. Since it burns solid fuel, soot and fly ash will accumulate more rapidly..

When wood is burned extremely slow, it produces tar and other organic vapors which may combine with expelled moisture to form creosote. The creosote vapors from a very slow burning fire may condense in the furnace heat exchanger or in the relatively cool chimney flue. As a result, creosote residue accumulates on the flue lining. If ignited, this creosote makes an extremely hot fire. A creosote fire may damage your chimney or start your house on fire.

To minimize creosote build-up, the wood/coal furnace should be fired hard with the underfire damper open for 15 to 30 minutes every morning to burn out the build-up flue pipe and chimney are already clean.

All installations and services must be performed by qualified service personnel.

The radiator, chimney cap and chimney should be inspected at least twice monthly during the heating season to determine if a creosote build-up has occurred. If creosote has accumulated, it should be removed to reduce the risk of a chimney fire.

In the back of each wood/coal furnace radiator are two clean out covers, which provide access to the inside of the radiator when cleaning. (See illustration below). These covers need to be removed so as to allow a thorough inspection and cleaning of the radiator. Be sure they are tightly sealed and that the gaskets are in place before refiring the furnace.

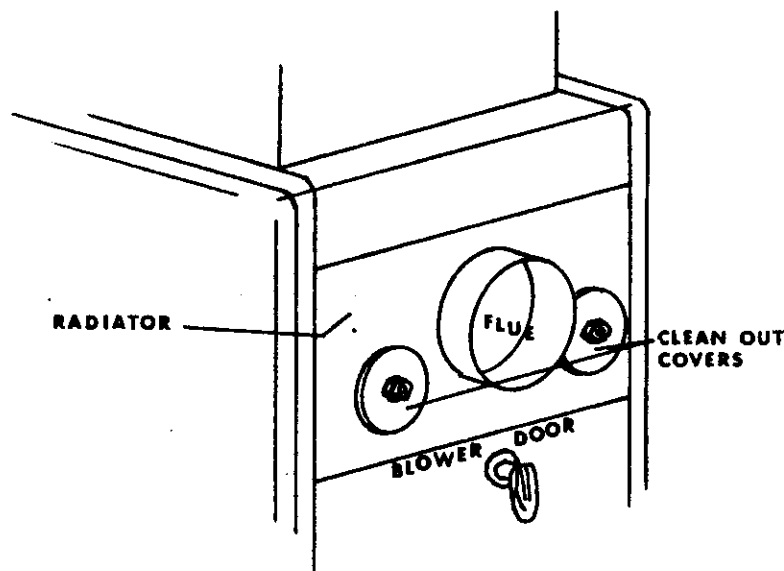

When making a visual inspection of the chimney, use a flash light and a mirror. If there are deposits, your chimney needs to be cleaned. Different batches of wood of various kinds and moisture content produce different amounts of creosote.

Experienced chimney servicing personnel should be consulted when cleaning becomes necessary. If you perform the operation yourself, you should acquire a stiff chimney brush and/or scraper in a shape and size to match your chimney.

Clean the soot and creosote from the top and sides of the furnace heat exchanger on a regular basis. A soot deposit as thin as 1/10" can decrease the efficiency of your wood/coal furnace by as much as 15%, due to resistance of heat transfer.

The exhaust flue inside the wood/coal furnace and the flue pipe connecting the furnace to the chimney should be inspected twice monthly until your own personal firing habits and type of fuel used set a pattern, and thus determine the amount of time you can wait between cleaning.

All installations and services must be performed by qualified service personnel.

PERIODIC MAINTENANCE

- 1) In the spring, after each heating season, clean the heat exchanger and radiator with a stiff brush. Then apply a thin coat of motor oil to the surfaces of the heat exchanger and radiator. Use a paint brush. This will protect your unit from rust due to condensation and moisture. Repeat this procedure each spring.
- 2) After the heating season is over, remove all the ashes from your unit. If wood ashes become wet, they will form lye and attack the metal in the combustion chamber.
- 3) Oil blower motor after each heating season. Oil the motor, according to the instructions on the motor name-plate. If oiling instructions are not given, use 10 to 15 drops of a non-detergent oil (SAE-20W) or a light electric motor oil.
- 4) You may clean the outside casing surfaces of your unit when it is cool. Use an ordinary non-abrasive household cleaner.
- 5) The filter in the blower compartment should be inspected monthly for an excess build-up of dirt. This filter can be cleaned with a garden hose by spraying out the dirt. Let the filter air dry completely before placing it back into the furnace.
- 6) Inspect the blower belt for excessive wear or play. When the belt is adjusted for proper tension or tightness, the belt should be able to move an inch up and down between the pulleys-

EXAMPLE:

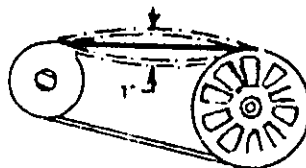

- 7) Inspect the feed door and ashpit door gasketing before each heating season for a good seal. If the door seal is poor, contact the dealer for repair.

CHIMNEY FIRE

You must do all you can to avoid an eliminate creosote and soot deposits. These substances are the fuel for a chimney fire and result from incomplete combustion of fuel. Rapid accumulation will occur when poor fuel is burned or when fuel is burned inefficiently. You should not burn wet or green wood. You should avoid a smoldering fire.

All installations and services must be performed by qualified service personnel.

A chimney fire is started when sparks or flames reach up into the chimney and ignite the accumulated residue. You must not burn large amounts of loose paper, twigs, or any other light fuel. These materials tend to carry flame up into the chimney.

You will recognize a chimney fire by the roar it makes. If you have a chimney fire, this is what to do-

- 1) Make certain that all other people are out of your home.
- 2) Call the Fire Department IMMEDIATELY.....
- 3) Cut off the oxygen supply to the chimney. To do this-
 - a) close the underfire damper...
 - b) close the overfire air ports...
 - c) keep both doors completely CLOSED...
- 4) Move all flammable objects away from the wood/coal furnace.
- 5) Unlatch the feed door. Stand to either side of the unit and open the feed door. DO NOT STAND DIRECTLY IN FRONT OF THE FIRE DOOR!
- 6) Throw a large amount of rock salt, or baking soda on the fire.
- 7) Close and securely latch the fire door. DO NOT THROW WATER ON OR INTO YOUR WOOD/COAL FURNACE. IF THESE STEPS ARE NOT CONTROLLING THE FIRE, GET OUT OF YOUR HOME AT ONCE!

Any chimney that experiences a fire should be CAREFULLY examined before it is used again. This can be done by your dealer or chimney cleaning firm or contractor.

A chimney fire may warp the inside of a metal chimney without having any effect on the outside wall. The intense heat of a chimney fire may cause the flue liner of masonry chimney to crack.

We recommend that you store a fire extinguisher, easily accessible, in the same area as the furnace. The fire extinguisher should be rated for Class B type fires, which are fires of flammable liquids, gases and greases.

All installations and services must be performed by qualified service personnel.

NOTE: Establish a routine for the storage of fuel, care of the unit and firing techniques. Check daily for creosote build up until experience shows how often cleaning is necessary. Be aware that the hotter the fire, the less creosote is deposited. Weekly cleanings may be necessary in mild weather even though monthly cleanings may be enough in the coldest months. Have a clearly understood plan to handle a chimney fire and for home evacuation.

TROUBLE SHOOTING PERFORMANCE PROBLEMS

WHAT TO DO IF YOU CANNOT START A FIRE...

1. When you build the fire, use a suitable fuel. Refer to table of WOOD CHARACTERISTICS on Page 33. Do not try to burn unseasoned fuel. Stack the initial pile of fuel loosely so it can get plenty of air. Use enough paper and kindling at the start to warm the chimney enough to establish a draft.
2. Ignite a crumpled ball of paper to the rear of the combustion area. Ignite it at the same time you ignite the paper under the kindling. This will also help to induce a draft.
3. Do not add larger pieces of fuel until the fire has established a strong draft. Draft should be between .04" and .06" W.C.
4. If you still have problems, you may have too weak of a draft, due to poor chimney construction or a hindering condition. Review Pages 3 through 8 on "CHIMNEY".

WHAT TO DO IF YOU CANNOT GET ENOUGH HEAT...

1. Open the underfire damper approximately a few links in distance on the no-call for heat cycle. The fire may be nearing extinction between calls for heat by the thermostat due to lack of oxygen. Be sure adequate combustion air is available to the furnace.
2. Check fuel--it may be necessary to use a fuel which gives off more heat. Refer to table on "Wood Burning Characteristics" on page 33, and "Coal Characteristics" on page 31. Also, the fuel may contain excess moisture if not properly cured. Experiment with known cured wood. If you are burning coal, it may be advantageous.
3. Check draft--if you do not have a draft between .04" and .06", you may have chimney problems. Refer to pages 3 through 8 on "Chimney Inspection".

All installations and services must be performed by qualified service personnel.

4. Check the ductwork to be sure it is of adequate size to move adequate CFM. If unit is tied into the ductwork of a companion unit, check to see if the warm air is cycling back through the companion unit. If so, a back-draft damper may have to be added to the blower of the companion unit. This will stop the warm air from cycling through the companion unit and instead force the air from the wood/coal furnace into the house.

5. The return air duct system must be of the same size as the warm air duct system. This will allow the warm air to circulate into the home easily. Be sure the air filter is clean.

WHAT TO DO IF YOU GET TOO MUCH HEAT...

1. Examine your fuel. You may be able to use a fuel that gives off less heat. Refer to table of "Wood Burning Characteristics" on page 33.

2. Simply use less fuel at each loading and reduce combustion air to the fire by closing down the overfire air ports and making certain that the under fire damper is closed all the way on the no-heat cycle (for WOOD firing only). This will enable you to get longer burn periods.

3. If the draft is in excess of .08" water column, a manual damper may have to be put in the flue pipe ahead of the barochek to lessen the intensity of the fire if closing down the air to the fire does not work.

WHAT TO DO IF YOU GET SMOKE SPILLAGE WHEN DOOR IS OPEN...

1. Before opening the feed door, leave the underfire damper open completely for a period of two minutes. This will increase the intensity of the fire creating a stronger draft and will decrease the possibility of a smoldering fire which will produce smoke before opening the door. Also, open the door slowly, NOT with a jerk, so the door will not draw smoke out.

2. If your home is tightly insulated, turn all exhaust fans OFF in the kitchen and bathroom before opening the door. If the home is extremely tight, air for combustion may have to be vented into the room in which the furnace is located. Refer to "Ventilation For Combustion Air".

3. Close the underfire damper just before opening the feed door to induce the draft to be drawn in the feed door after it is open. Then close the feed door when finished loading and return the underfire damper to its original position.

All installations and services must be performed by qualified service personnel.

4. Try to have all wood or coal needed for one fueling at the furnace so that it can be put in quickly before heavy smoking occurs.

WHAT TO DO IF YOU GET SMOKE SPILLAGE WHEN DOOR IS CLOSED....

1. Take draft reading and if the reading is below .04" water column, review Chimney, Fuel sections and Ventilation For Combustion Air sections of these instructions.

If you open a window or door and the smoke spillage stops, you must duct in air for combustion to the furnace. Review Ventilation For Combustion Air section on page 12.

2. Check door gasketing for leaks. Repair and/or replace, if necessary.

3. Some causes and solutions for a weak draft may be:

<u>CAUSES</u>	<u>SOLUTIONS</u>
a. Inadequate chimney.	Review Chimney section for size and construction requirements.
b. Improper barometric control setting.	Measure draft and adjust the barometric control accordingly. Also, review Barometric Installation instructions.
c. Flue pipe restrictions.	Review flue pipe connection section and inspect for build-up and creosote.
d. Inadequate rise in flue pipe.	Raise flue pipe entry into the chimney to the maximum allowable height. Also, review Flue Pipe Connection section.
e. Dilution of flue draft caused by improper connection of an appliance to the same chimney.	Seal off possible air leaks. Review Chimney section.
f. Restrictions due to excessive ashes, soot or creosote.	Clean furnace, flue pipe and chimney, as required.

NOTE: A draft inducer may solve poor draft problems. Keep in mind that due to outside conditions; i.e., terrain or tree interference, a draft inducer may be required even on a "good" chimney.

All installations and services must be performed by qualified service personnel.

WHAT TO DO TO CONTROL THE LENGTH OF BURN TIME

1. Most people would like to achieve a reasonable overnight burn time of 6 to 8 hours. Learning a few facts and making a few simple adjustments can help a person control the length of time one load of wood or coal will burn. Some of these facts adjustments are listed below -

A. Outside temperature - These furnaces are thermostatically controlled and, as the outside temperature lowers, the demand for heat increases and the fire will consequently burn hotter and last a shorter period of time. The only way to compensate for this is to reduce the thermostat setting on colder days.

B. Draft - An excessive draft will make the fire burn hot at all times and reduce the length of burn. Adjustments should be made to the length of chain controlling the underfire damper and the barometric draft control. In particular, the ash pit door damper should probably not open more than 1/2" to 3/4" when calling for heat and should close completely when not calling for heat. (Reference Fuel Section - Page 29). The barometric draft control on the flue pipe should also be adjusted to compensate for draft. Normally, when calling for heat it should be fully closed, but in some situations of very strong draft it possibly should be partially open when calling for heat and fully open when not calling for heat. We would like to emphasize the necessity for trying varying settings and changing the settings at different times of the year as weather conditions change.

The overfire air ports may also affect burn time. When burning wood a more closed position may be required, while a coal fire likely will require more overfire air. Experimentation with the overfire air ports and with the particular fuel and grade (type) of fuel will be necessary.

C. Wood - The variety of wood burned can make a large difference in the amount of burn time. The denser hardwoods such as hickory, oak and apple will give the longest burn time, while the least dense woods such as pine, poplar and birch will burn for the shortest periods of time. Moisture content will also affect the burn time, but burning wet or green wood will decrease the heat put out and also will increase the creosoting problems, so this is generally not advised. The diameter of the wood burned has a marked effect on the total burn time. Wood that is small in diameter or finely split will burn for much shorter periods of time than larger pieces. People getting the longest burn time seem to generally use wood six to eight inches in diameter to achieve their long burns, and they are very careful to load the furnace so that the maximum number of these larger logs are used within the limits of the refractory height.

All installations and services must be performed by qualified service personnel.

They are also careful to insure that all logs are parallel to each other and none are cocked horizontally or vertically, as these conditions do shorten the burn time.

D. Coal - The variety of coal burned can make a significant difference in the amount of burn time. Denser, high BTU value coals such as anthracite and low to medium volatile bituminous will burn longer periods while less dense, lower BTU value coals such as high volatile bituminous, sub-bituminous and lignite will be consumed faster. The size of the coal lumps is also a factor in that the larger sized will burn faster once they are thoroughly ignited. Coal classified as broken, egg and stove size are best suited to longer burns.

E. Shaking - To achieve a long burn, shake the grates as infrequently as possible, and incompletely, leaving a reasonable bed of ashes at all times. However, the ashes should not be allowed to build up on top of the grates to such an extent that combustion air is severely restricted from getting to the fire from the ash pit. Ashes definitely should NOT come closer than 3" to the bottom of the grates, as grate warpage could occur.

WHAT TO DO IF THE BLOWER IS SHORT CYCLING

The fan on any warm air furnace is controlled not by the thermostat, but by the temperature of the air in the plenum (the chamber on the top of the furnace). A device called the fan and limit switch is mounted in the plenum and senses the air temperature. This fan and limit switch has three settings which may be adjusted by removing the cover and moving each of the three indicators. These settings are:

lowest - fan shut off temp.
middle - fan turn on temp.
highest - limit (controls damper motor, shutting damper to fire, preventing higher temperatures).

Normal settings are:

high limit - 200 (This is the maximum allowable setting).
fan on - 150
fan off - 110

If the fan tends to short cycle (turns on and off frequently), it usually indicates either too low a fan-on temperature, too high a fan-off temperature, a combination of both conditions or a mislocation of the fan and limit switch in the plenum. Different settings should be tried to achieve the best fan operation.

All installations and services must be performed by qualified service personnel.

FURTHER INFORMATION....

For further information on using your furnace safely, obtain a copy of the NATIONAL FIRE PROTECTION ASSOCIATION publication- "Using Coal & Wood Stove Safely", NFPA #HS-8-1974. The address of the NFPA is - 470 Atlantic Avenue Boston, Mass. 02210.

The WC/20 and WC/27 furnaces have received approvals from the following Agencies:

- 1) ENERGY TESTING LABORATORY OF MAINE
Test Standards Used: ETLM 78-1
- 2) THE COMMONWEALTH OF MASSACHUSETTS
Department of Public Safety
- 3) STATE OF CONNECTICUT
Department of Public Safety

May 1989