

heatilator®

AMERICA'S LEADING FIREPLACE SYSTEMS

installation directions

MARK 123-38C

Heat Circulating
FIREPLACE

U.S. PATENT NOS. 3762391 and 3744477
CANADIAN PATENT 942,148

INDEX	GENERAL INFORMATION 2, 3	FRAMMING 7, 8, 9	OFFSET/ELBOW/CHIMNEY 14, 15
	ACCESSORIES 4, 5	STEP-BY-STEP 10, 11, 12	GAS DEVICES 15
	PLANNING 6	OPTIONAL INLET KIT 13	TERMINAL CAP, CHASE, CHASE TOP 16

BUILDING AUTHORITIES, REFER TO THE FOLLOWING: UNDERWRITERS' LABORATORIES, INC. NO. MH5850 (LOOK FOR THE LABEL), BUILDING OFFICIALS AND CODE ADMINISTRATORS INTERNATIONAL, INC. NO. 69-10, INTERNATIONAL CONFERENCE OF BUILDING OFFICIALS NO. 1141.

These directions are based on the NATIONAL BUILDING CODE recommended by the American Insurance Association.

CAUTION: Read the directions completely (including directions packed with component parts) BEFORE beginning installation.

WARNING: A safe installation of this fireplace requires proper use of authorized (listed) components ONLY, and careful attention to details and workmanship when installing each component. **INSTALLER NOTE:** A fireplace rendered unsafe through use of unauthorized items, insufficient clearances to combustible construction, or poor practices of any description can cause a building fire. FOLLOW DIRECTIONS TO AVOID CREATION OF HAZARDOUS INSTALLATION.



A COMPLETELY NEW FIREPLACING SIMPLIFIED CONCEPT

A real fireplace and auxiliary or emergency heating system in one unit. Lightweight, built-in, woodburning, fully controllable, heat circulating factory-built fireplace. Easy to handle components quickly install to a complete, operating fireplace. Position anywhere (See diagram A)—along any wall; 45° across corner; in chase, closet or garage area or enhance a room divider. Install flush with wall, partially projecting or fully projecting with a flush or raised hearth. Leave flatte Black as finished, paint any color to harmonize or contrast with total room effect, or conceal with brick, stone, marble, glass, slate, etc. Finish trim options are unlimited.

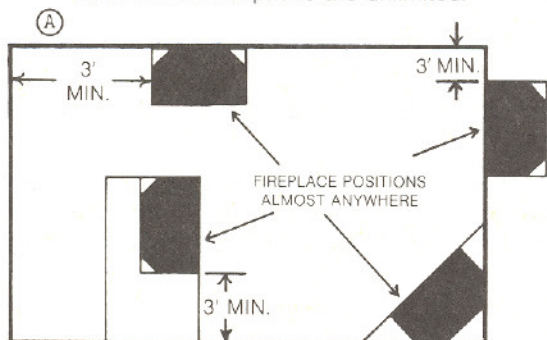

CONTROLLABLE HEAT CIRCULATION WHEN AND WHERE DESIRED

Individually controllable left and right DUCTS from fireplace to wall OUTLETS carry clean warm air which was heated in special chambers inside the fireplace. One outlet **only** may be used from each side. The outlets are not, however, required to be in the same room (see diagram B). Outlets may be installed in the fireplace room, or in another room, or one outlet per room. The warm air rises naturally, or may be assisted by the optional fan-equipped INLETS (order CAT.NO. 600 KIT). Heat circulation through OUTLETS may be stopped (when heat is not needed) by use of the pull-chain controls. Internal air circulation within the fireplace does not stop, however, but continues in order to maintain safe temperatures of all metal arts and of combustible construction of the building. ALL AIR FLOW CEASES when fire is completely out and damper has been closed.

FUN WITH FOOD

The fireplace is equipped with a socket in the hearth which accepts the specially-designed Barbecue Grille (C), CAT. NO. 6260, an optional accessory ordered separately. grille swings on pivot arm, adjusts for height.

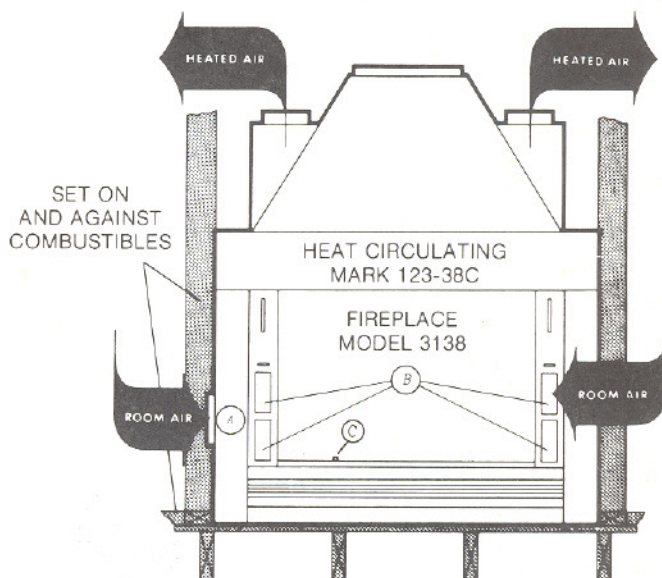

AIR ENTERS (A) IF ASSISTED BY OPTIONAL FAN KIT (B) UNASSISTED

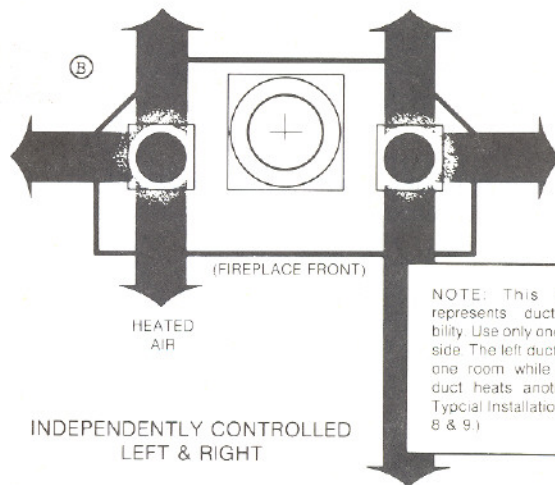

NOTE: This diagram represents ducting flexibility. Use only one duct per side. The left duct can heat one room while the right duct heats another. (See Typical Installations, Pages 8 & 9.)

The Model 3138 is intended for supplementary and emergency heating in year-round homes, NOT full-time sole-source heating. Vacation homes may be adequately served by the Model 3138 used alone, depending on size, insulation, and area.

GENERAL INFORMATION

1. The Heatilator Mark 123-38C (CAT. NO. 3138) Fireplace is shipped complete with the following: basic fireplace with screen, chimney 2' starter section and two each of the following Fireplace Duct parts: Cat. No. 606 - 6" length, Cat. No. 612 - 12" length, Cat. No. 690 - 90° adjustable elbows and two Outlet Assemblies (with grilles) for installation in wood frame or masonry walls. Grilles are prime-painted, may,be finished any color.

IMPORTANT: OUTLETS - The self-locking FIREPLACE DUCT parts shipped with the fireplace are of double-wall construction, AND ARE REQUIRED FOR DUCTS WHICH LEAD TO THE OUTLETS. **Maintain 1" minimum clearance to combustible construction when installing Fireplace Duct.** Never employ ordinary piping of single-wall type for ducting to outlets. Order additional self-locking, FIREPLACE DUCT parts, if required for your installation, from the items shown on the ACCESSORIES pages---the diagrams showing typical installations will be helpful in determining which extra FIREPLACE DUCT parts might be necessary.

INLETS - The optional 115v Fan Inlet Kit, CAT. NO. 600, described in the ACCESSORIES pages and elsewhere in these directions, does NOT require use of Fireplace Duct, and is not sized to accept it. In some installations, the FAN INLET ASSEMBLY will enter the fireplace side without need for additional pipe. When required, use 6" dia. locally-purchased single-wall galvanized pipe and fittings for inlet ducting. No clearance to combustibles for inlet ducting is necessary, because air entering is at room temperature.

2. The fireplace may be installed directly on a combustible floor and the fireplace sides and rear may be in contact with combustible walls or wall framing members. **WARNING: PROVIDE COMPLETE FULL-AREA SUPPORT BENEATH FIREPLACE TO BEAR WEIGHT OF UNIT AND ITS CHIMNEY—DO NOT SUPPORT FIREPLACE AT A FEW POINTS ONLY WITH BLOCKS OR FLOOR JOINTS.** (To raise fireplace above floor, construct a sturdy platform with full wood covering.)
3. The fireplace may be installed anywhere along walls or in corners. **EXCEPTION:** A minimum clearance of 3' must be maintained from the fireplace opening to any combustible wall which projects at 90° to the fireplace opening. The fireplace may, however, be installed 45° across a room corner.
4. The fireplace can be installed **ONLY** with the specified chimney and roof termination, (Single or Double Housings, Contemporary Cap or Terminal Cap) and cannot be connected to any other flue.
5. The **STARTER SECTION**, which is shipped with the fireplace, must be installed vertically on top of the fireplace, or, if 15° or 30° fireplace offsets are employed to bend the chimney within the fireplace room, the **STARTER SECTION** may be inclined on top of the offset, and may incline only to left, right, rear, or front.
6. The **STARTER SECTION** (and **OFFSET**, if employed) must be installed with not less than 2" clearance to combustibles.
7. Heatilator Mark 123 **CHIMNEY SECTIONS** (9" I.D.) are used above the Starter Section. Use 6" height, Cat. No. 906; 2' height, Cat. No. 912; or 3' height, Cat. No. 912, as required. **CHIMNEY SECTIONS** must be installed with not less than 2" clearance to enclosure walls, ceilings, joists, floors and roof structure. (**CHIMNEY SECTIONS ARE 14" O.D.** and require ceiling and floor openings 18" x 18".)
8. A **FIRESTOP SPACER** must be used for each floor or ceiling penetrated (not necessary at roof). Use Cat. No. 3932 for vertical chimney; use Cat. No. 3916 for a chimney inclined through ceiling at 15°; use Cat. No. 3931 for a chimney inclined through ceiling at 30°.
9. For Single or Double Housings, **CHIMNEY SECTIONS MUST REACH A MINIMUM OF 6" ABOVE THE HIGH SIDE** of the roof opening **AND** meet the Slip Section with a **minimum of 2" engagement.**
10. Overall height of fireplace and chimney to be **NOT LESS THAN 12'**, and **NOT MORE THAN 50'**. (**EXCEPTION:** Height of chimney supported by Return portion of **OFFSET**, Cat. No. 3915 or 3930, may be up to 47' maximum.)

11. The Housing (or the CONTEMPORARY CAP) should extend at least 3' above the highest point where it passes through the roof and at least 2' higher than any portion of a building within 10'. Roof openings for HOUSINGS are: Single, 18" x 18"; Double, 18" x 38". Roof opening for CONTEMPORARY CAP is 18" x 18". (All roof openings are measured on horizontal.) See Installation Directions which accompany HOUSING or CONTEMPORARY CAP.

USE OF **TERMINAL CAP ON LOCALLY-CONSTRUCTED CHASE:** Study complete details, page 16. This new technique of enclosing fireplace and its chimney, or chimney only, requires merely competent planning and construction to be successful. **HEIGHT OF CHASE, WITH CAP, IS IMPORTANT AND IS EXPLAINED IN DETAIL.**

12. The floor (or surface of platform, if fireplace is elevated) in front of the fireplace is termed the HEARTH EXTENSION. Hearth Extension must extend at least 16" in front of and at least 8" beyond each side of the fireplace opening. Hearth Extension must be not less than 3/8" thick approved non-combustible material. (Factory-built steel Hearth Extension of extra-large 20" x 60" dimensions is shown on page 5; this metal accessory, if selected, may be painted or covered with non-combustible material.)

WARNING: Never allow unprotected wood, carpet, or any other combustible materials to exist in hearth extension prescribed area.

13. If desired, a gas log lighter may be installed in the Mark 123-38C Fireplace. (Such devices are not made by Vega Industries, Inc.) See Installation Directions "Gas Devices", page 15. (Gas Logs, if desired, may also be installed, but it should be anticipated that the heat-circulating function of the fireplace may be reduced.)

14. The Heatilator Mark 123-38C Fireplace is completely insulated by high-temperature batt insulation, reflective metal, and special refractory hearths. In addition, cooling air enters top and bottom of fireplace opening and maintains safe temperatures. **DO NOT BLOCK OR ALTER AIR ENTRIES IN ANY WAY,** which are clearly detailed in illustrations.

WARNING: DO NOT INSTALL GLASS DOORS. (A special glass door assembly for this model may become available in the future. Write for information.)

COOLING AIR ENTRIES

(The small but important flows of air shown below merge near top of hood and pass to outside of building via chimney.)

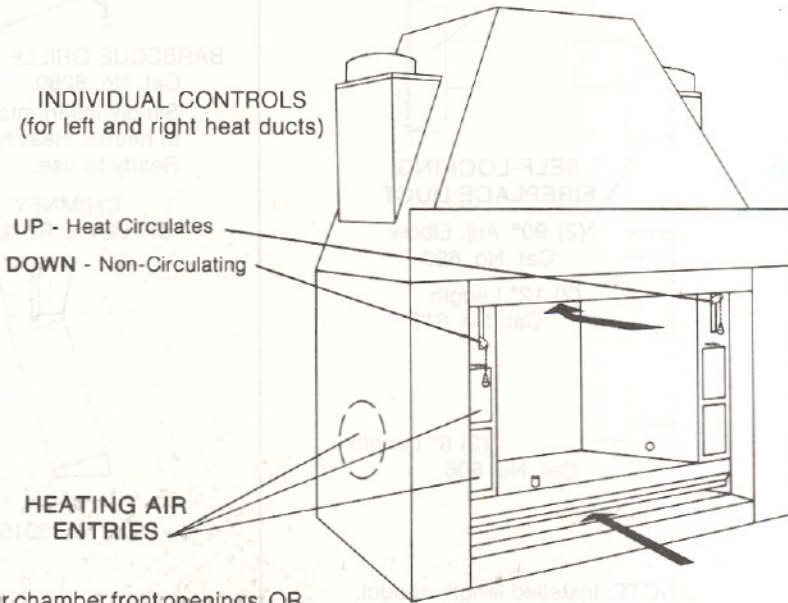

(1) Air passes under cover which conceals screen rod; air rises inside fireplace hood.

(2) Air passes over cover near floor and under hearth; air rises in fireplace to cool outer surfaces of back and sides.

Air enters four chamber front openings, OR, with Inlet Kit, air passes into chamber via side entries, the four openings in chamber front then being covered (covers shipped as part of Inlet Kit).

ALL AIR FLOWS CEASE COMPLETELY WHEN FIRE OUT, DAMPER SHUT

ACCESSORIES

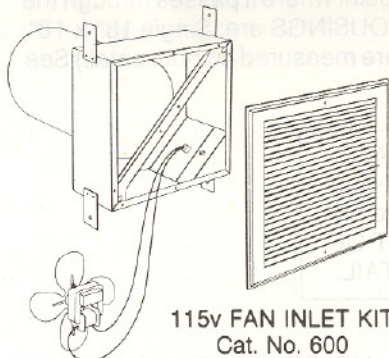

115v FAN INLET KIT
Cat. No. 600

(Two each inlet boxes, prime-painted grilles, motors, etc.- assembled, ready to wire.)



Cat. No. 916
Adjustable 0°-30° Elbows
(2 elbows, 2 joint bands per carton)



Cat. No. 906
6" Chimney Section
(Sometimes needed with Offsets, or with Chase installations using Terminal Caps.)



Cat. 913
3' Chimney Section

Cat. No. 912
2' Chimney Section

INSTALLATION COMPONENTS

The illustrations below show components included in the Fireplace Package.

Above and at right are shown all optional accessories which might be required or preferred to complete your installation. Asterisked (*) items may be substituted. An item shown UNDERLINED> is required for every installation.

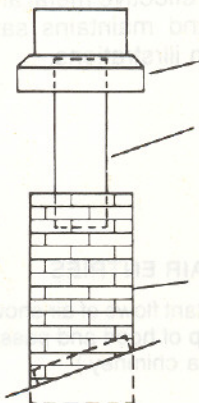

***1' SINGLE HOUSING TOP**
Cat. No. 1842M

***SLIP SECTION**
Cat. 910

***3' HOUSING PANELS**
(with Roof Flashing)
18" x 18"
Cat. No. 1442
Red Brick

CHIMNEY SECTIONS
Use 6", Cat. No. 906;
2', Cat. No. 912; or
3', Cat. No. 913 insulated
chimney sections as
required. (Effective
height of section is $\frac{3}{4}$ "
less than nominal height.)

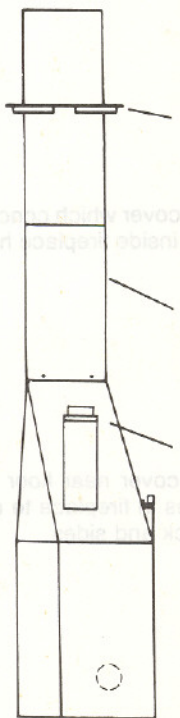

FIRESTOP SPACER
Cat. No. 3932
Vertical Chimney
(Firestop Spacer
No.3916 or No.3931
may be required.)

2' STARTER SECTION
(Included with
fireplace)

FIREPLACE
Cat. No. 3138

(Fireplace Duct parts shipped with fireplace are the minimum items normally used. See typical installation diagrams. Unused duct parts included with fireplace are not returnable.)

ITEMS SHOWN BELOW ARE INCLUDED WITH FIREPLACE:

(2) OUTLETS
Complete with Grilles

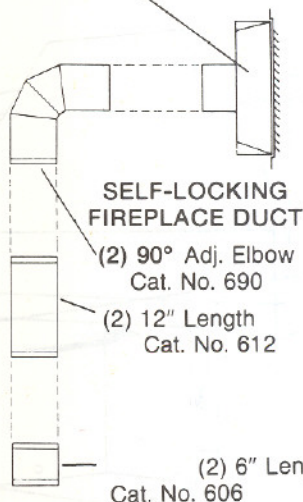

**SELF-LOCKING
FIREPLACE DUCT**

(2) 90° Adj. Elbow
Cat. No. 690

(2) 12" Length
Cat. No. 612

(2) 6" Length
Cat. No. 606

NOTE: Installed length of duct parts is $\frac{1}{2}$ " less than nominal length.

SEE PAGE AT RIGHT FOR COMPLETE DESCRIPTIONS AND DIMENSIONS OF ADDITIONAL DUCT PARTS AVAILABLE.

GRATE—Cat. No. 26
Raises fire off hearth for better fireplace operation, holds fuel together for even burning.



GRATE
Cat. No. 26

Holds logs, may be lined with aluminum foil when using charcoal under barbecue grille.

WARNING: Guarantee of Heattilor Fireplace is void unless this grate or equivalent is used.



BARBECUE GRILLE
Cat. No. 6260

Simply insert into socket in hearth. Heavily chromed. Ready to use.

**CHIMNEY
OFFSET & RETURN**

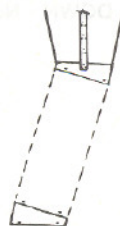

15°
Cat. No. 3915

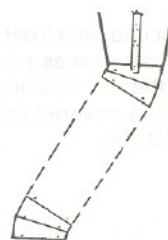

30°
Cat. No. 3930

FIRESTOP SPACERS

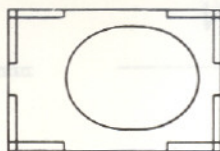
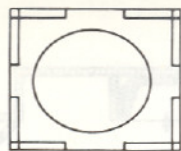
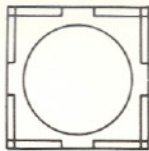

Cat. No. 3932
(Opening: 18" x 18")
For Vertical Chimney

Cat. No. 3916
(Opening: 18" x 21 1/2")
Use with 15° Inclined Chimney

Cat. No. 3931
(Opening: 18" x 26 1/2")
Use with 30° Inclined Chimney

---WARNING---
The **INSTALLER** is reminded, again, that only parts which are authorized (as shown on these pages), received undamaged at site, properly employed, and installed with care will result in a safe installation. (The only locally-fabricated part permitted is the **CHASE TOP**, page 16; the inlet duct may be locally purchased.)

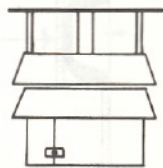

Cat. No. 925
Terminal Cap
(See page 16)

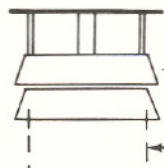

CONTEMPORARY CAP including
2' AND/OR 3'
CHIMNEY SECTIONS
(ORDER SEPARATELY)

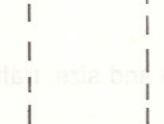

STORM COLLAR
ROUND FLASHING
ROOF FLASHING
and
CHIMNEY BRACKET

Cat. No. 921
For roof pitches to 12/12 (to 45°)

Cat. No. 924
For roof pitches 12/12 to 24/12 (over 45°)

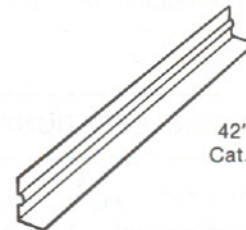

42" LINTEL
Cat. No. 3950

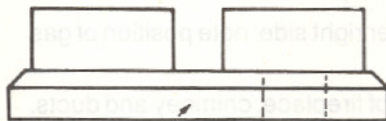

Double Housing Top
Cat. No. 1860

Slip Section

DOUBLE HOUSING TOP - Cat. No. 1860

NOTE: The Mark 123-38C Fireplace can be installed in combination with other kinds of fireplaces or appliances. With **DOUBLE HOUSING**, a 7" or 9" Slip Section will be required for the second chimney, depending on the appliance to be vented (Adapter included with 7" size). **DOUBLE HOUSING** may also be used with only **ONE** chimney - cover disc for unused half is included with **DOUBLE TOP**. Order **ONE** (if required) for second chimney:

- 9" Slip Section - Cat. No. 910
- 7" Slip Section - Cat. No. 710

FACTORY-BUILT HEARTH EXTENSION (METAL)

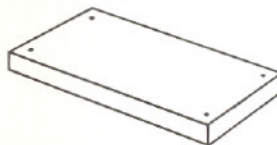
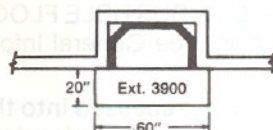

CONTEMPORARY CAP or **TERMINAL CAP** may be substituted for the Single or Double Housing Panels & Tops. **ONE OF THESE TERMINATIONS OF THE CHIMNEY ABOVE THE ROOF MUST BE USED.** When ordering Contemporary Cap be sure to specify Cat. No. according to roof pitch, so correct flashing type will be included in package.

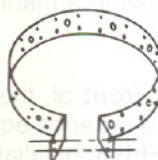

JOINT BAND - Cat. No. 922 (3 per carton) Required for reinforcing joint between Chimney Sections **ONLY** when sections are inclined or are exposed above roof.

SELF-LOCKING FIREPLACE OUTLET DUCT PARTS

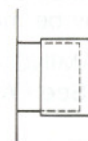

Wall Thimble
Cat. No. 680
(Adjusts for 3 1/2" to 6" walls)

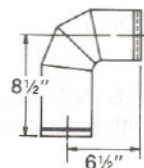

6 1/2" OD
0°-90° Adj. Elbow
Cat. No. 690



6 1/2" OD
12" Nom. Adjustable Length
Cat. No. 670
(Telescopes from 9 1/2" max. true to 1 1/2" min. true)



6 1/2" OD
18" Nom. Length
Cat. No. 612
(10 1/2" true)



6 1/2" OD
18" Nom. Length
Cat. No. 618
(16 1/2" true)



6 1/2" OD
6" Nom. Length
Cat. No. 606
(4 1/2" true)

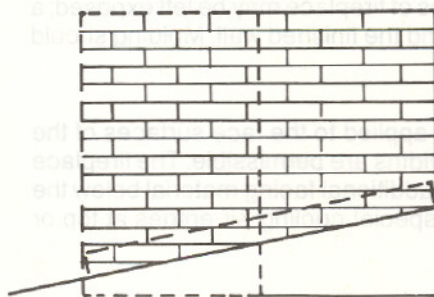

SINGLE | DOUBLE
18" x 18" | 18" x 36"

3' HOUSING PANELS (White) Cat. No. 1441 | **3' HOUSING PANELS (White) Cat. No. 1641**
(Red) Cat. No. 1642

5' HOUSING PANELS (White) Cat. No. 1461 | **5' HOUSING PANELS (White) Cat. No. 1661**
(Red) Cat. No. 1462 | (Red) Cat. No. 1662

All panel sets include Roof Flashing

PLANNING CONSIDERATION

CHECK LIST

IMPORTANT: INSULATE CAREFULLY ALL EXTERIOR WALLS which surround fireplace, as shown by symbol  in diagram at right. Especially, note that **CHASE** surrounding fireplace is fully insulated; also, if fireplace is in a cold garage, enclose and insulate thoroughly. This prevents cold metal surfaces in winter, with corresponding reduction of drafts and heat loss.

FRAMING CONSIDERATIONS:

FIREPLACE LOCATION will be influenced by such factors as room plan and size, traffic in rooms and door and window openings. See diagram at right showing some location possibilities.

CHIMNEY and DUCT installation (including **OUTLET** and **INLET** location) must be carefully considered. See typical installation diagrams, page(s) 7, 8, & 9.

FLOOR which must support installation need not be reinforced unless sizable facings of heavy material are intended.

GAS LINE (required only when optional gas device is to be installed) should be planned to enter right side; note position of gas pipe entry on fireplace diagrams.

OVERHEAD CONSTRUCTION (joists, trusses, rafters, pipes, etc.) may indicate best location of fireplace, chimney and ducts.

FRAMEWORK around the fireplace may be planned to include bookshelves, woodbins, closets, or other flues from floors beneath. Such built-ins may be made accessible from front, sides, or rear.

FIREPLACE OPENING FRAMING will be governed by **flush** or **projecting** facing materials and how far above or to sides of opening these will extend. See **FACING MATERIALS**.

HEARTH EXTENSIONS:

WHEN THE FIREPLACE IS INSTALLED ON A COMBUSTIBLE FLOOR, a **Hearth Extension** must be employed to protect the floor in front of and on either side of the opening. See General Information, Paragraph 12.

HEARTH EXTENSIONS and entire fireplace may be **recessed into the floor**, installed **on the sub-floor or finished floor**, or **raised on a suitable platform**. If recessed or raised, provide a level surface strong enough to support the fireplace, chimney and **Hearth Extension**.

FACING MATERIALS:

It is not a requirement that facing be used. When preferred, the black-painted front surfaces of fireplace may be left exposed; a "picture frame" molding is usually employed to conceal the joint between the fireplace and the finished wall. Molding should overlap not more than $\frac{1}{4}$ " of metal fireplace front.

NON-COMBUSTIBLE FACING MATERIAL (glass, marble, brick, tile, stone, etc.) may be applied to the face surfaces of the installed fireplace. Minimums of 4" at sides and 6" at top have been established; greater widths are permissible. The fireplace may be elevated on its own platform above the hearth extension area to permit the use of additional facing material below the fireplace opening. **CAUTION:** Do not use facing material in a manner which will block special cooling air entries at top or bottom of the fireplace opening.

FACING MATERIAL may be **flush**, or **projecting** in front of, the finished wall surface. For **FLUSH** facing material, the **FIREPLACE** is recessed behind surface of finished wall a distance equal to facing thickness; for **PROJECTING** facing material, the **FIREPLACE** is flush with finished wall surface. (**Flush** installation is recommended for smooth or thin facings, with a "picture frame" molding used to conceal joint between facing and finished wall. **Projecting** installation permits a shallower cavity to enclose the fireplace and enhances the appearance of massive natural materials, with side joints between facing and finished wall concealed by caulking and top of projecting material concealed by a mantel installed across the top.) A mantel, if used, must be at least 12" above the fireplace opening.

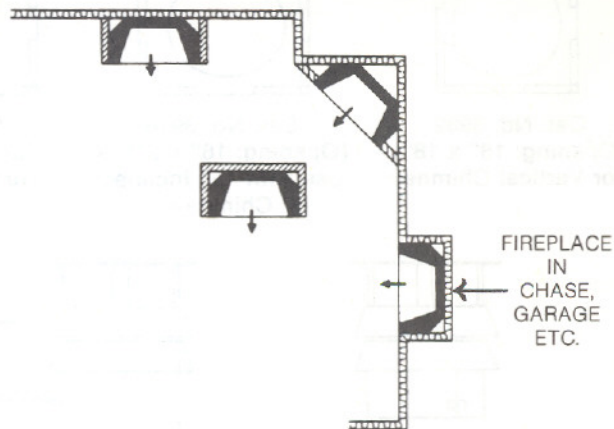

FRAMING THE FIREPLACE

The illustrations may suggest possibilities, but may not serve exactly as shown for your installation. Determine SUPPORT method first, then the ENCLOSURE FRAMING. It is important to remember that FACING FLUSH WITH FINISHED WALL SURFACES requires "Setback" measured from the surface of finished wall to metal front of fireplace. If FACINGS PROJECT IN FRONT OF FINISHED WALL SURFACE, align metal front of fireplace with surface of finished wall.

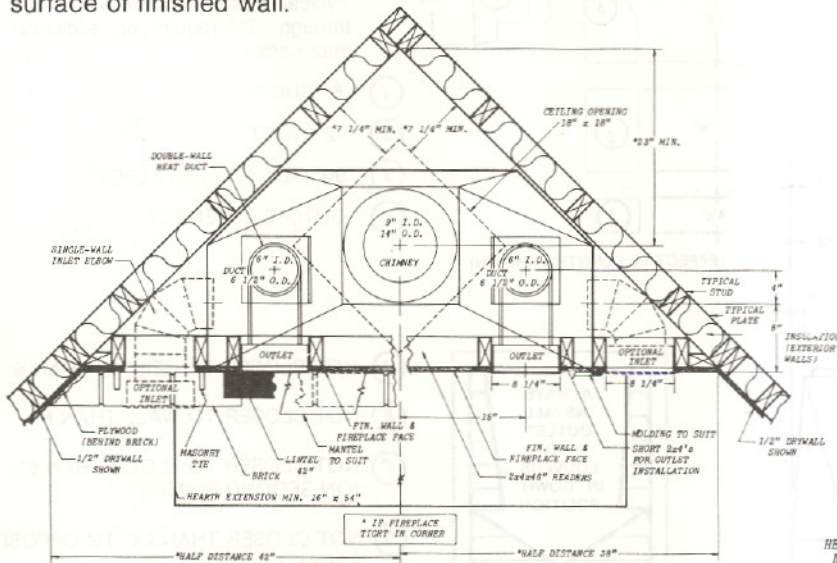
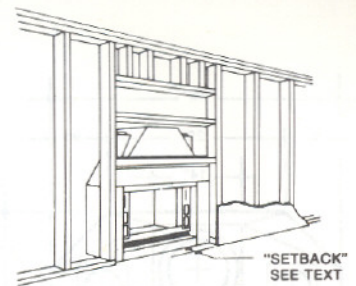

THIS HALF DIAGRAM TYPICAL CORNER INSTALLATION FIREPLACE FLUSH WITH WALL, BRICK PROJECTS IN FRONT OF WALL UP TO MANTEL HEIGHT

THIS HALF DIAGRAM TYPICAL CORNER INSTALLATION FIREPLACE FLUSH WITH WALL, NO FACING

TYPICAL FIREPLACE ON FLOOR OR PLATFORM SIDE VIEW

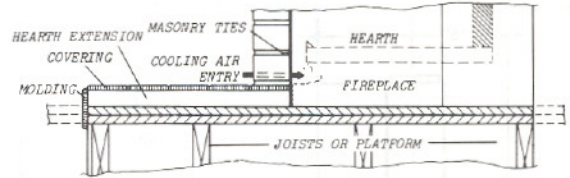

NOTE: BRICK FACING SHOWN; SUBSTITUTE OTHER IF DESIRED

HEARTH EXTENSION AND FIREPLACE RECESSED SIDE VIEW

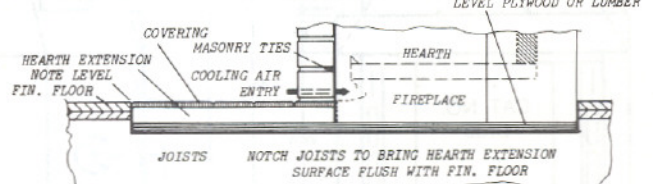

NOTE: BRICK FACING SHOWN; SUBSTITUTE OTHER IF DESIRED

RAISED FIREPLACE FOR FULL (FOUR SIDES) GLASS FACING SIDE VIEW

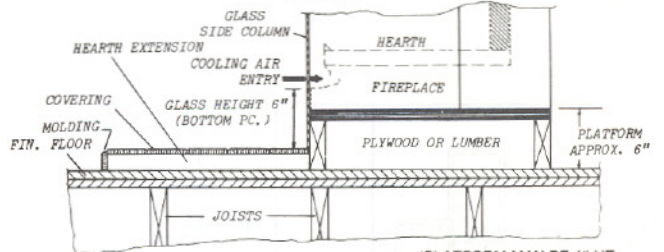

(PLATFORM MAY BE 4" HT. IF FIREPLACE IS ON NON-COMBUSTIBLE FLOOR SURFACE)

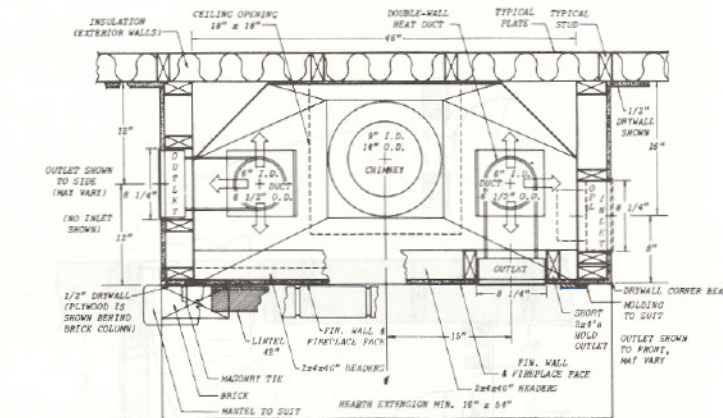

THIS HALF DIAGRAM TYPICAL WALL INSTALLATION FIREPLACE FLUSH WITH WALL, BRICK PROJECTS IN FRONT OF WALL UP TO MANTEL HEIGHT

THIS HALF DIAGRAM TYPICAL WALL INSTALLATION FIREPLACE FLUSH WITH WALL, NO FACING

3/4" SLATE, MARBLE, ETC. - FLUSH

(FOR OTHER THICKNESS CHANGE "SETBACK")

BRICK - PROJECTING

BRICK - FLUSH

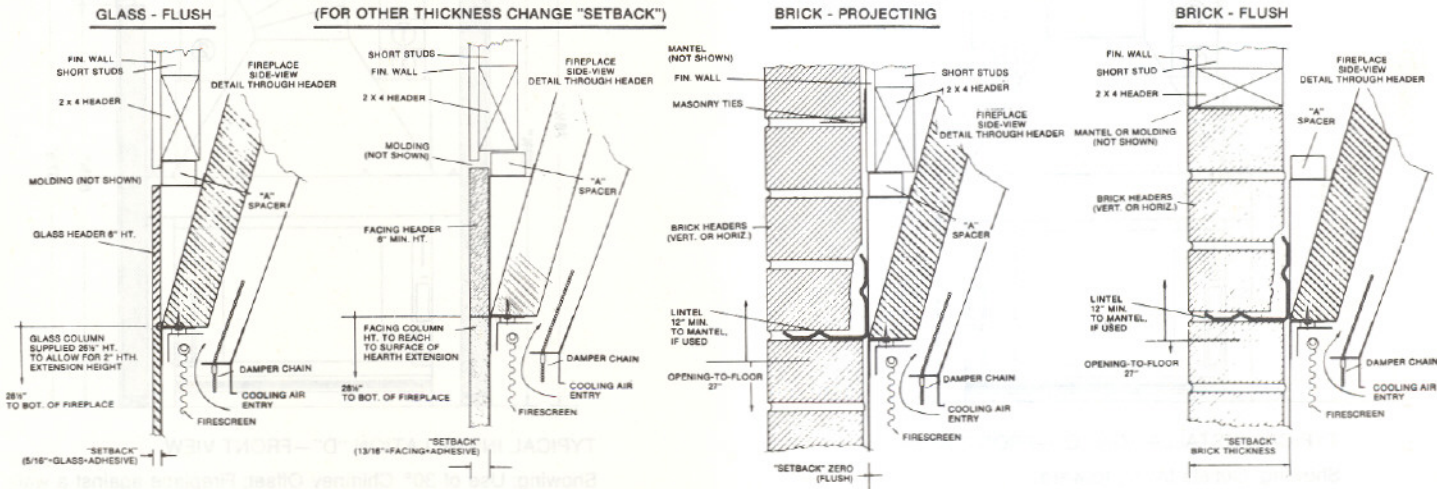

NOTE: "GLASS" may be 1/4" mirror, opaque colored glass, or thin tile. Adjust SETBACK distance to accommodate thickness of material.

TYPICAL INSTALLATIONS

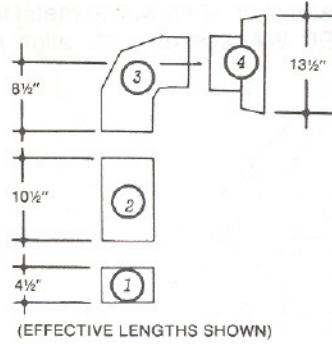
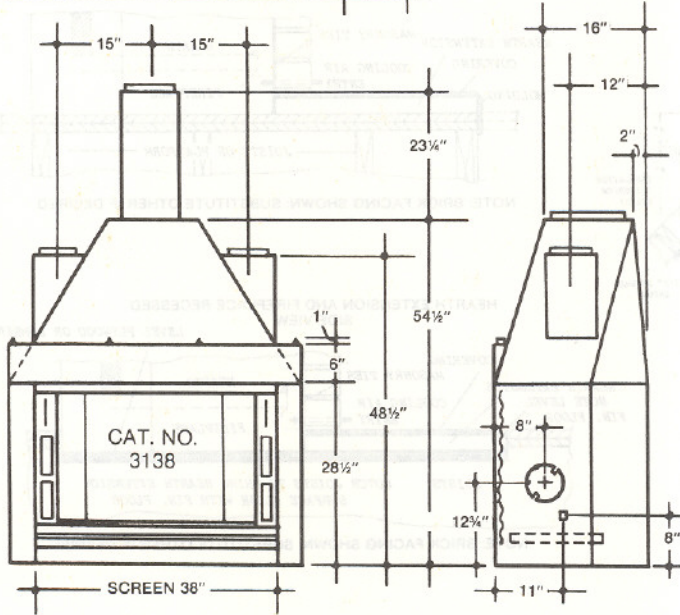
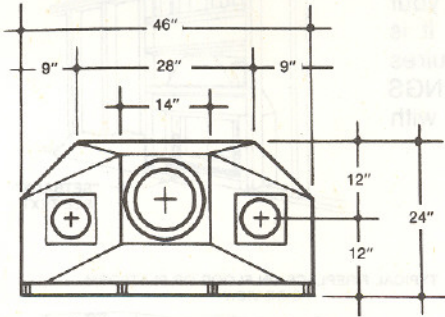

Two each of the numbered duct parts are included with fireplace.
Typical Installation Drawings "A" through "D" require no additional duct parts.

- ① 6" DUCT
- ② 12" DUCT
- ③ 90° ADJUSTABLE ELBOW
- ④ OUTLET ASSEMBLY

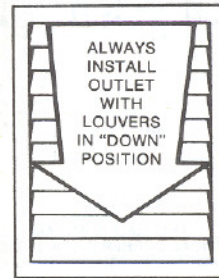

- Ⓐ NOT CLOSER TO CEILING THAN 6"
- Ⓑ NOT CLOSER TO WALL THAN 6"
- Ⓒ NOT CLOSER TO FLOOR THAN 6" (ON SECOND FLOOR)
- Ⓓ NOT CLOSER THAN 24" TO OPPOSITE PARALLEL WALL

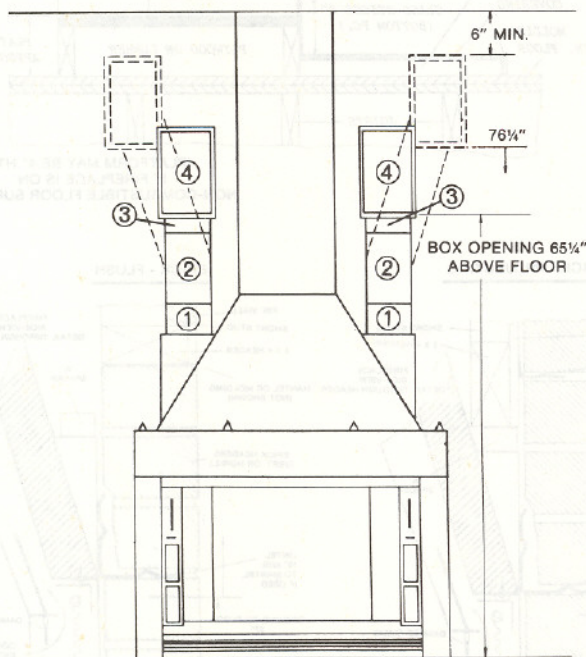

TYPICAL INSTALLATION "C"—FRONT VIEW

Showing: Outlets facing forward;
Fireplace on floor (anywhere);
8'0" ceiling room (96");
Supplied duct parts used (lower outlets);
Additional duct parts used (upper outlets).

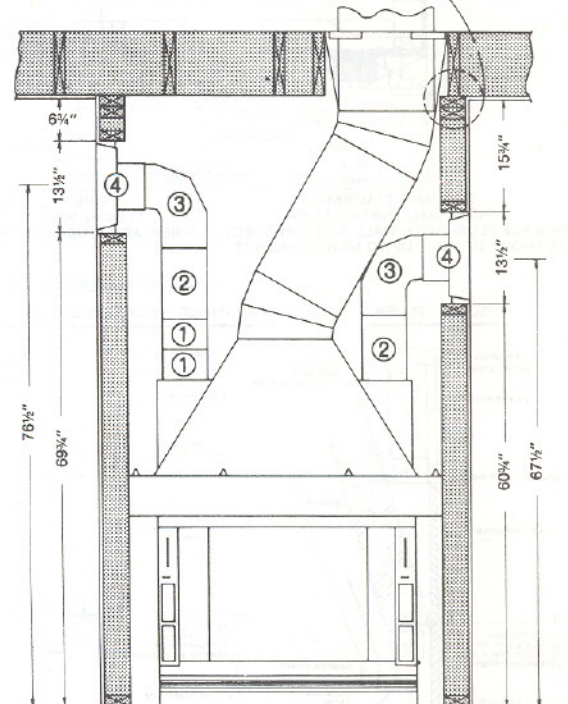

TYPICAL INSTALLATION "D"—FRONT VIEW

Showing: Use of 30° Chimney Offset; Fireplace against a wall;
Fireplace on floor; 7'6" ceiling room (90");
Supplied duct parts used (note duct installation);
Outlets in left and right walls.

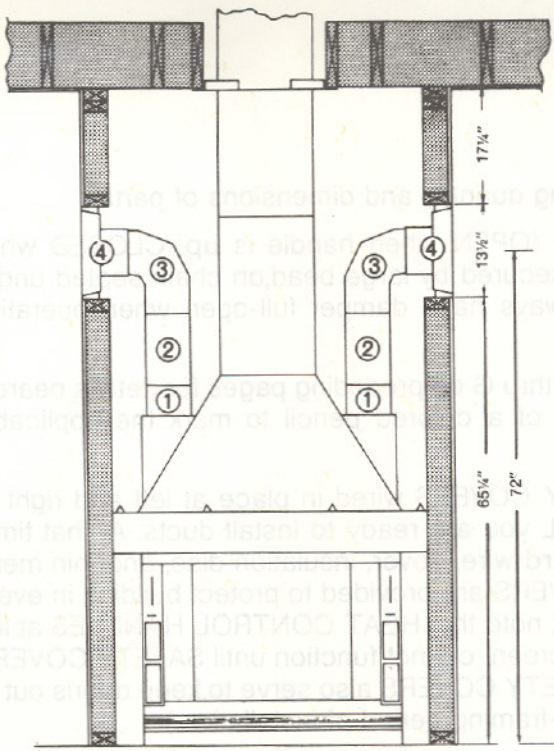

TYPICAL INSTALLATION "A"—FRONT VIEW

Showing: Fireplace against a wall;
 Fireplace on floor;
 8'0" ceiling room (96");
 Supplied duct parts used;
 Outlets in left and right walls.

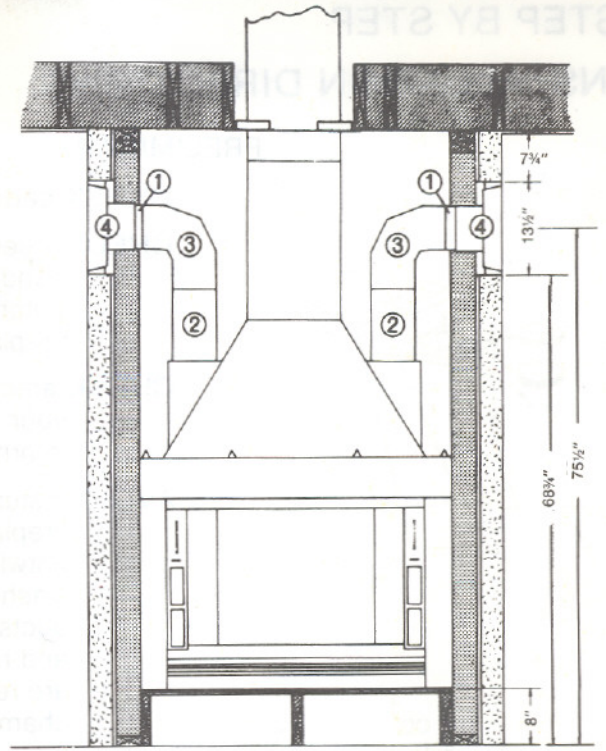

TYPICAL INSTALLATION "B"—FRONT VIEW

Showing: Fireplace against a wall;
 Fireplace on raised hearth;
 7'6" ceiling room (90");
 Brick veneer over 2 x 4 framing;
 Supplied duct parts used;
 Outlets in left and right walls.

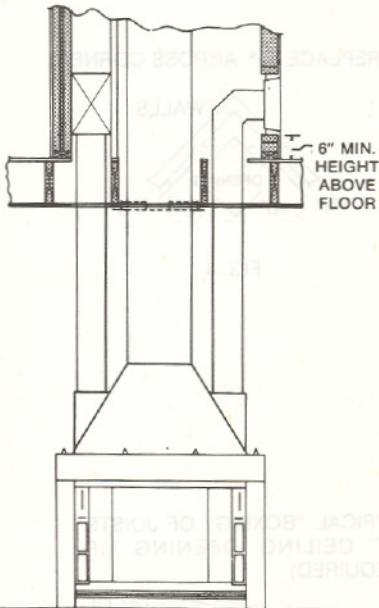
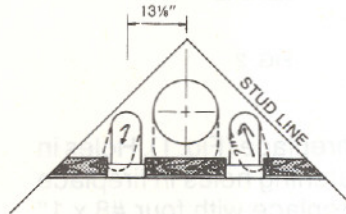
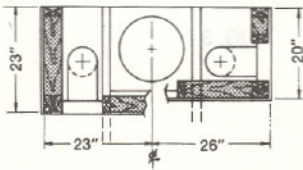

TYPICAL INSTALLATION "E"—FRONT VIEW

Showing: Outlet location in upper rooms;
 Fireplace on floor (anywhere);
 Use of firestops;
 Representative 2nd floor framing
 (see Plan View);
 Outlet directions (may vary).

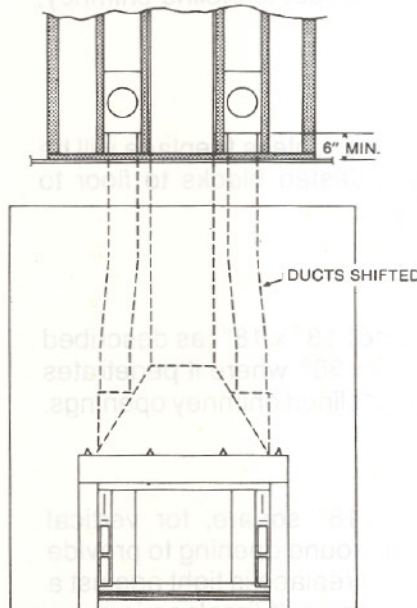

TYPICAL INSTALLATION "F"—FRONT VIEW

Showing: Fireplace installed in corner;
 Outlet location in upper rooms;
 Chimney & ducts offset 7" to rear
 (to save upper floor space);
 Outlet direction (may vary).
 NOTE: Use of firestops same as E installation.

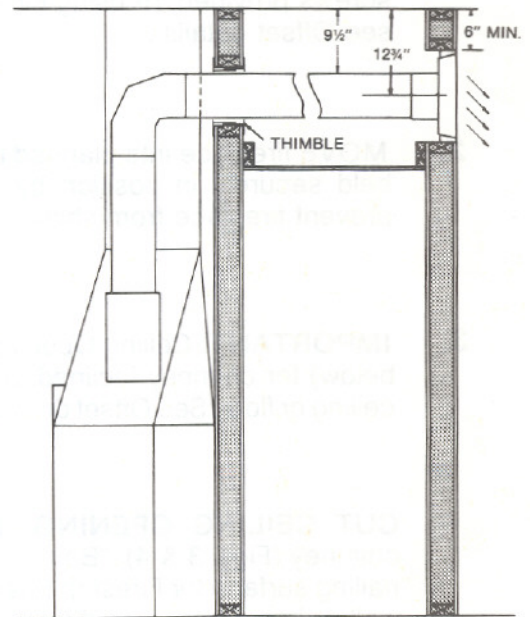

TYPICAL INSTALLATION "G"—SIDE VIEW

Showing: Method of locating Outlet in
 remote room;
 Duct penetrates partition wall;
 Partition Thimble use to
 maintain clearance.

STEP BY STEP

INSTALLATION DIRECTIONS

PRELIMINARY:

CHECK carton contents, noting quantity and dimensions of parts.

CHECK operation of damper (OPEN when handle is up, CLOSED when handle is down and secured by large bead, on chain seated under notch in bracket). Always have damper full-open when operating fireplace.

CHECK among EXAMPLES A thru G on preceding pages for details nearest your installation---use of a colored pencil to mark the applicable information is helpful.

AVOID disturbing the SAFETY COVERS wired in place at left and right of fireplace hood---UNTIL you are ready to install ducts. At that time, untwist wire and discard wire, cover, insulation disc, and thin metal washer. (SAFETY COVERS are provided to protect building in event ducts are not installed; note that HEAT CONTROL HANDLES at left and right, behind firescreen, cannot function until SAFETY COVERS are removed. The SAFETY COVERS also serve to keep debris out of chamber during rough-framing period of installation.)

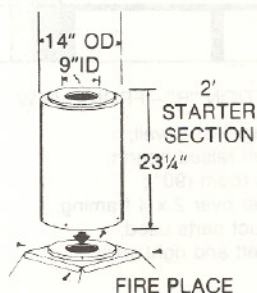
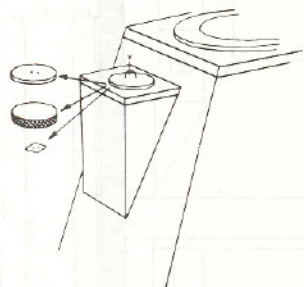

FIG. 1

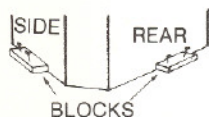

FIG. 2

FIREPLACE AGAINST WALL

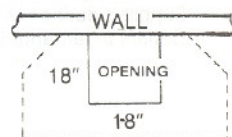

FIG. 3

1. MOUNT the Starter Section on top of fireplace (Fig. 1). Holes in bottom of Starter Section align with matching holes in fireplace top. Secure Starter Section to top of fireplace with four #8 x 1" screws provided. (If using Fireplace Offset to incline chimney, see Offset details.)

2. MOVE fireplace into planned location. Unless fireplace will be held securely in position by walls, fasten blocks to floor to prevent fireplace from shifting (Fig. 2).

3. IMPORTANT: Ceiling Opening is not 18" x 18" (as described below) for chimney inclined at 15° or 30° where it penetrates ceiling or floor. See Offset details for inclined chimney openings.

FIREPLACE 45° ACROSS CORNER



FIG. 4

CUT CEILING OPENING, 18" x 18" square, for vertical chimney (Figs. 3 & 4). "Box" (Fig. 5) around opening to provide nailing surface for Firestop Spacer. If fireplace is tight against a wall or in a corner, use dimensions shown. If fireplace is away from wall, use plumb line or straight edge with level to locate center of opening, gauging on center of closed damper. (If Fireplace Ducts will lead to an upper floor, study appropriate installation diagrams showing ceiling penetration of chimney and ducts.)

TYPICAL "BOXING" OF JOISTS AT CEILING OPENING (IF REQUIRED)

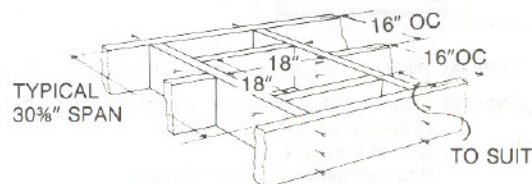

FIG. 5

4. **FIRESTOP SPACER** is installed next, as shown in Fig. 6, for all openings not at attic level; as shown in Fig. 7 for opening leading to an attic. Nail through flanges into joists. Do not pack insulation into areas between Firestop Spacer and joists. **OFFSET NOTE:** When hanger straps of Offset Return interfere with normal "upward" installation, install Firestop Spacer "downward" (Fig. 7).

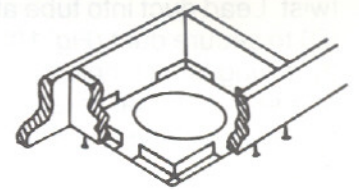

FIG. 6

5. **CONTINUE** adding Chimney Sections, until chimney exits above roof. (Note Paragraph 9 of GENERAL INFORMATION.) Any ceilings encountered are "boxed" at 18" x 18" as described, and Firestop Spacers are installed. Roof openings should be plumbed from last Firestop Spacer, then cut according to roof termination used. **NOTE:** Chimney Sections are locked together by a firm clockwise twist, which engages mating threads at ends (Fig. 8). **ADDITIONAL REINFORCEMENT** is required only when chimney is inclined (see details under OFFSET or ELBOW directions), or when chimney is exposed above roof (see details in CONTEMPORARY CAP installation directions).



FIG. 7

6. **ROOF TERMINATION** is completed according to detailed directions shipped with the termination selected. (See termination options under ACCESSORIES.)

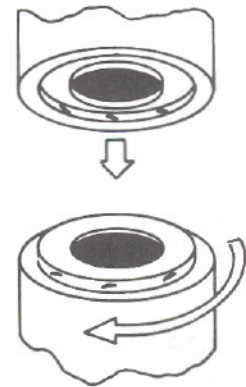

FIG. 8

7. **FRAMING** is completed after a trial assembly of duct parts and outlets on fireplace; this procedure indicates where 2 x 4 members should be placed and allows a check of minimum clearances (grille must be at least 6" from any ceiling, wall, or floor; grille must not direct warmed air towards an opposite wall which is closer than 2'). If outlets are in an upper room, or if ducts penetrate a partition, frame these areas first. Frame around fireplace last.

Easiest procedure is to construct "end walls" first, as shown in Fig. 9 at right---varying dimensions to suit your requirements. When end walls are in place, nail in horizontal 2 x 4 headers. Short vertical 2 x 4 members are for nailing of outlet and inlet assemblies. In Fig. 9, dimension "X" will be 24", equal to fireplace depth, but note this includes thickness of wall material; the framing is 24" minus wall material thickness. (Fig. 9 illustrates a typical installation being prepared for "no facing" or for such facings as brick or stone which will project in front of finished wall surface; fireplace front will be flush with finished wall surface.)

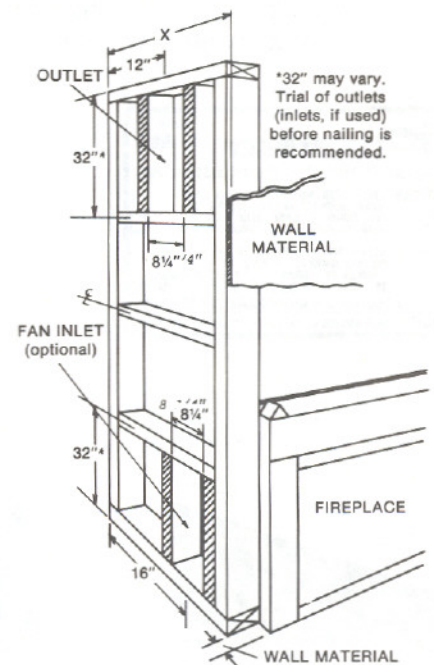

FIG. 9

8. **TO INSTALL OUTLETS** (Fig. 10): Disassemble by removing Grille (A), then Liner (B), and nail Outlet (C) into prepared space in 2 x 4 frame, or anchor with nails in mortar joints if using masonry finished wall. It is important that two-hole end of Outlet is UP. Use four nails of not less than 4d size. **CAUTION:** OUTLET MUST BE NAILED SO THAT FRONT FLANGES WILL BE FLUSH WITH THE FINISHED WALL SURFACE. Example: If using 1/2" drywall over 2 x 4's, nail Outlet so that it protrudes 1/2" from 2 x 4's. (**NOTE:** In some installations, duct parts should be in place BEFORE nailing of outlets, to avoid difficulty in getting duct downward on fireplace collar and inserted into Outlet tube. See next paragraph.)

9. **INSTALL** each duct run from fireplace; duct parts lock by twist. Lead duct into tube at rear of Outlet; tighten tube clamp (D) to secure duct (Fig. 10). Secure first duct part to fireplace by drilling $\frac{1}{8}$ " dia. hole through duct and collar, fastening with one #8 x 1" metal screw supplied (Fig. 11). Complete Outlet nailing, if delayed until now, in accord with Paragraph 8.
10. **RE-INSTALL** Liner in Outlet. The Grilles will not be installed until wall covering is in place. Lay Grilles and grille screws safely aside.
11. **TO INSTALL CAT. NO. 600 INLET KIT:** See special installation directions, next page.
12. **FINISHING** of wall, followed by application of facing and hearth extension, completes the installation. It is optional whether facing or hearth extension is installed first--- materials used will dictate best procedure.

Facing of brick, stone, or other heavy materials should be anchored to fireplace front or to wall framing with numerous Masonry Ties (bent steel clips, with hole for securing) in mortar joints. A LINTEL resting on side columns of masonry supports the masonry across the top of fireplace opening.

Less massive facings, such as glass or marble, are applied with a suitable adhesive to fireplace front surfaces. Provide support for facing until adhesive sets.

FIRESCREEN ASSEMBLY is secured by two screws through metal angle, at ends. To remove assembly, for any reason, remove screws.

OPERATING INSTRUCTIONS for fireplace use are on metal plate permanently secured behind firescreen near left side heat control handle.

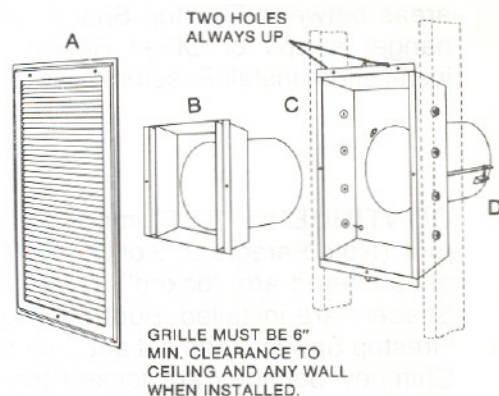

FIG. 10

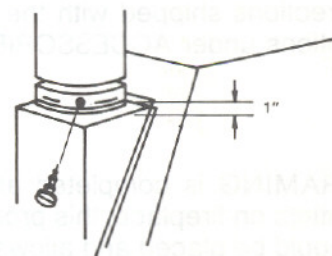
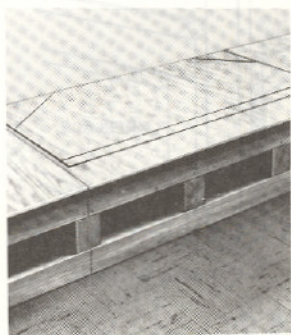

FIG. 11



1. Platform to support fireplace and provide raised hearth.
2. Fireplace unit in position on platform and against wall.
3. Conceal fireplace and heat circulating duct with 2 x 4 framing and wall material.
4. Final finish as you want it. The choice of non-combustible surround and room finishing treatment is endless.



1

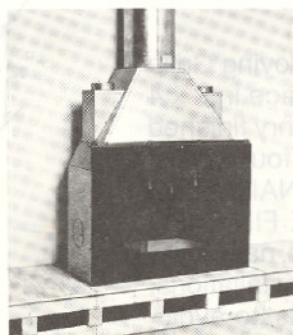

2

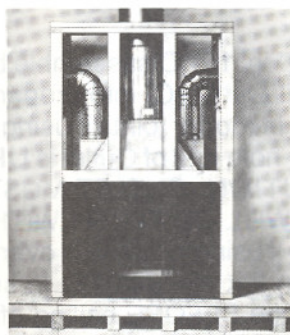

3

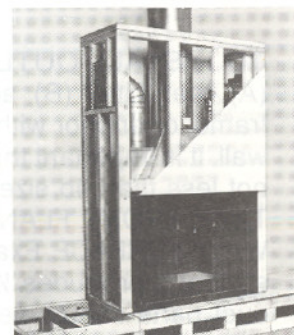

4

INSTALLING OPTIONAL Cat. No. 600 INLET KIT

INLET KIT consists of (2) Inlet Assemblies, (2) Grilles and (2) Covers.

COVERS are used to permanently block normal air inlets in front of heating chamber (Fig. A). To install, remove four screws, place cover over openings and re-install screws.

REMOVE 6" DIA. DISCS from fireplace sides. Remove and discard insulation which is in tubes under discs. Bend tabs outward (Fig. B).

FIREPLACE IS NOW READY to receive tube end of Inlet directly, or a straight or elbow section of 6" diameter locally-purchased galvanized pipe. Installation requirements vary, but **ALL** must have:

CRIMPED ENDS TOWARD FIREPLACE, TIGHT JOINTS, PIPE SECURED WITH METAL STRAPS OR SCREWS, AND SCREW-FASTENED PIPE AT TABS AS PIPE ENTERS FIREPLACE.

REMINDER: Inlet duct is single-wall piping, needs no clearance to combustibles. Inlets may be located in fireplace room, or in another room or hallway. (When possible, locate Inlet Assembly in same room served by heat Outlet, to achieve best circulation. But do not, under any circumstances, install Inlet Assembly at a height above inlet hole in fireplace.) **NOTE:** Tube at rear of Inlet may be cut shorter if required for your installation.

TYPICAL INSTALLATIONS are shown at right (Fig. C, ALONG A WALL) and below (Fig. D, CORNER). Framing previously explained for Outlets, is similar for Inlets. Note in Figs. C and D that Inlets and Outlets are NOT on the same vertical line—Outlets are 12" from front and back of fireplace, while Inlets are 16" from back, 8" from front.

TO INSTALL INLETS, remove Grille, nail Inlet tabs to 2 x 4 members (or bend tabs 90° to anchor in masonry) using 4 nails of not less than 4d size. Be sure front of Inlet is located so that it will be flush with surface of the finished wall (Fig. E).

WIRING: May include one wall switch to control both fans, or separately-switched fans, depending on Outlet location. Power enter electrical wiring space built into corner of Inlet. Check fan blade and motor mount screws for tightness. Motor has permanent lubrication, requires no oiling.

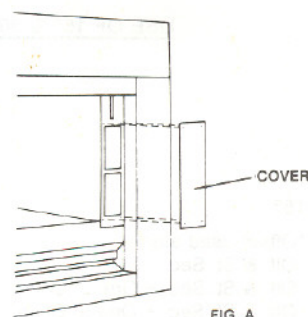

FIG. A

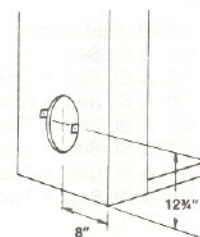

FIG. B

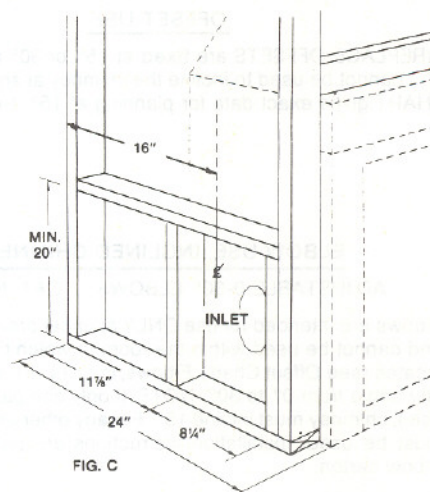

FIG. C

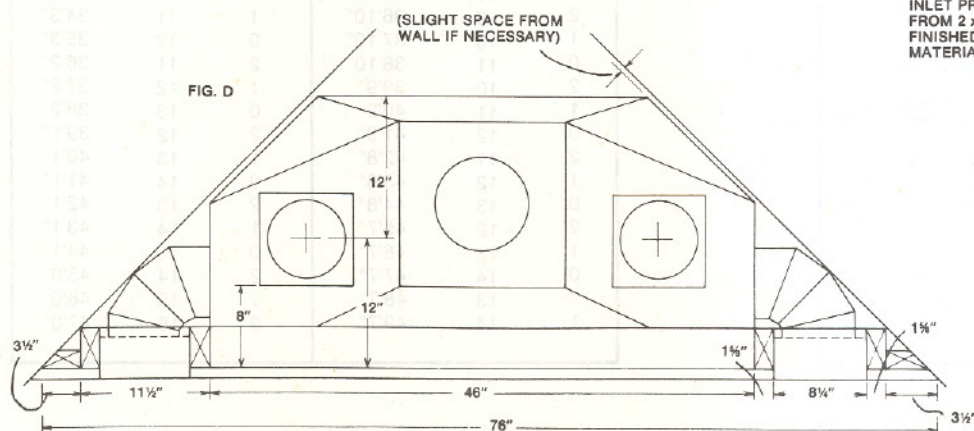

FIG. D

INLET PROTRUDES FROM 2 x 4 EQUAL TO FINISHED WALL MATERIAL THICKNESS.

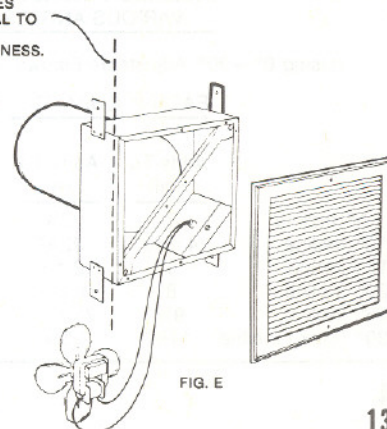

FIG. E

FIREPLACE OFFSET CHART

USE OF 15° & 30° OFFSETS

	"A" TOTAL SHIFT	"B" HT. FROM TOP OF FIREPLACE TO TOP OF THE SUPPORT OFFSET
15°		
*Offset used alone	1"	30¼"
Off. & St. Sec.	7"	29½"
Off. & St. Sec. + One 2' Chim.	13"	51¾"
Off. & St. Sec. + One 3' Chim.	16"	63¼"
Off. & St. Sec. + Two 2' Chim.	19"	74"
Off. & St. Sec. + One 2' Chim. + One 3' Chim.	22"	85¾"
Off. & St. Sec. + Two 3' Chim.	25"	97¼"
30°		
*Offset used alone	4"	37"
Off. & St. Sec.	15"	33¾"
Off. & St. Sec. + One 2' Chim.	27"	53¾"
Off. & St. Sec. + One 3' Chim.	33"	64"
Off. & St. Sec. + Two 2' Chim.	39"	73¾"
Off. & St. Sec. + One 2' Chim. + One 3' Chim.	45"	84¼"
Off. & St. Sec. + Two 3' Chim.	51"	94½"

*On top of vertically-installed Starter Section.

OFFSET USE

FIREPLACE OFFSETS are fixed at 15° or 30° at the factory, and cannot be used to incline the chimney at any other angle. CHART gives exact data for planning at 15° and 30°.



ELBOW USE, INCLINED CHIMNEYS

ADJUSTABLE 0-30° ELBOWS CAT. NO. 916

Elbows are intended for use ONLY at upper areas of chimney, and cannot be used within the room in which the fireplace is located (see Offset Chart). Elbows, in pairs, are adjustable for any angle from 0° to 30°. NOTE: If only one pair of elbows is used, chimney must incline 15°. For any other angle, two pairs must be used. Installation instructions are packed in each elbow carton.

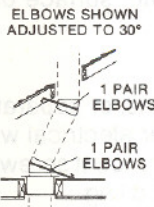

INCLINED CHIMNEYS AT VARIOUS ANGLES

(Using 0°—30° Adjustable Elbows—See Elbow Text)

	EACH 2' CHIM. SEC.		EACH 3' CHIM. SEC.	
	Adds To Shift	Adds To Ht.	Adds To Shift	Adds To Ht.
5° Incline	2"	23¾"	3 1/16"	35 1/16"
10° Incline	4 1/16"	22¾"	6½"	34 11/16"
15° Incline	6"	22 7/16"	9¾"	34"
20° Incline	8"	21 13/16"	12 1/16"	33¾"
25° Incline	9¾"	21 1/16"	14¾"	31 15/16"
30° (Max.) Incline	11¾"	20¾"	17¾"	30½"

HEIGHT LIMITATIONS

"Height of chimney SUPPORTED BY FIREPLACE to be not more than 45 ft." (Chart 1)

"When a Chimney Offset is employed, the height of chimney SUPPORTED BY OFFSET to be not more than 47 ft." (Chart 2)

VERTICAL INSTALLATION HT. TO CHIMNEY TOP



INCLUDES THE
FIREPLACE, 2'
START. SEC., &
CHIM. SEC. SHOWN

2 ft. Sec.	3 ft. Sec.	Height	HT.—CHIMNEY ONLY (ABOVE OFFSET)		
			2 ft. Sec.	3 ft. Sec.	
				Height	
			1	0	1'11"
			0	1	2'11"
			2	0	3'10"
			1	1	4'10"
			0	2	5'10"
			2	1	6'10"
			1	2	7'10"
			0	3	8'10"
			2	2	9'9"
			1	3	10'9"
			0	4	11'9"
			2	3	12'8"
			1	4	13'8"
			0	5	14'8"
			2	4	15'7"
			1	5	16'7"
			0	6	17'7"
			2	5	18'7"
			1	6	19'7"
			0	7	20'7"
			2	6	21'6"
			1	7	22'6"
			0	8	23'6"
			2	7	24'5"
			1	8	25'5"
			0	9	26'5"
			2	8	27'4"
			1	9	28'4"
			0	10	29'4"
			2	9	30'4"
			1	10	31'4"
			0	11	32'4"
			2	10	33'3"
			1	11	34'3"
			0	12	35'3"
			2	11	36'2"
			1	12	37'2"
			0	13	38'2"
			2	12	39'1"
			1	13	40'1"
			0	14	41'1"
			2	13	42'1"
			1	14	43'1"
			0	15	44'1"
			2	14	45'0"
			1	15	46'0"
			0	16	47'0"

USE OF FIREPLACE OFFSET AND OVAL FIRESTOP SPACER

OBSERVE—LIMITATIONS ON OFFSET USE

OFFSET is intended for use **ONLY** in the fireplace room, **EXCEPT** that the inclined chimney may penetrate the ceiling (with the **RETURN** portion of the offset installed within or above the ceiling construction).

FURTHER LIMITATIONS:

1. **OFFSET** may incline chimney 15° or 30° **ONLY** (purchase correct factory-assembled sets).
2. Chimney may **INCLINE** to left, right, rear, or front--as viewed from front of fireplace.
3. **MAXIMUM** inclined chimney length is 8'.
4. **FIRESTOP—SPACER** must be installed whenever the chimney penetrates a ceiling.
5. **JOINT BAND** must be used to reinforce every joint at bottom of an inclined chimney section, except for screw-fastened Starter Section.
6. **HANGER STRAPS** of the Return Offset must be securely fastened on all four sides to substantial construction to safely carry the weight of all chimney sections above.

INSTALLATION: Assemble Starter Offset to Starter Section, mount assembly on fireplace. Secure with #8 x 1" screws supplied. If inclined chimney will penetrate ceiling, see Firestop Spacer directions below. Otherwise, install Return Offset. (See Steps 3 & 4 of STEP-BY-STEP Instructions for regular vertical Firestop Spacer use.)

Nail hanger straps to wood members of boxed opening (Fig. 1) using at least 3 nails per strap, min. 8-penny size. (Firestop Spacer installs "downward" when straps fasten to joists.) If hanger straps are located where they cannot reach the joists, install wood members appropriate for nailing.

SPECIAL SUPPORT OFFSET NOTE: When Return Offset Section mounts on regular Chimney Section (Cat. Nos. 912 or 913), punch or drill four holes 1/16" dia. in upper end of chimney, using holes in Support Offset as a guide. Be sure top surface of Return Offset is level when screw-fastened to section below so rest of the chimney rises plumb.

OVAL FIRESTOP SPACERS: Using straightedge as illustrated (Fig. 2), mark point on ceiling where inclined chimney's "upper surface" will penetrate. Construct "boxed" opening 18" wide by appropriate length. Opening begins 2" outside ceiling mark, as shown (Figs. 3 and 4).

NOTE: For floors thicker than 1 1/2", construct opening longer than regular, and fill in as shown to keep required 2" clearance.

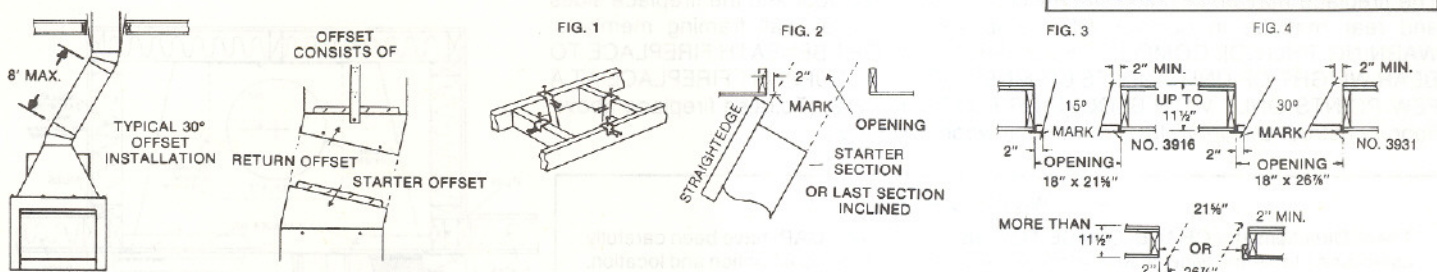

MARK 123 FIREPLACE GAS DEVICES

If desired, a gas log lighter may be installed in the Mark 123-38C Fireplace. (Such devices are not made by Vega Industries, Inc.) Installation should follow these directions, and special attention should be given to any other information supplied with the gas device.

OBSERVE THE FOLLOWING PRECAUTIONS:

- (a) Use only 1/2" iron pipe, and appropriate iron fittings.
- (b) Use only a model having a valve designed for installation outside the fireplace. A removable key affords extra safety. (Such a model is shown in Fig. 1).
- (c) Cap the pipe stub end in the chamber of the fireplace until the device is installed, or when device is removed for any reason.

STEP-BY-STEP

1. Note the Tube Shield and Pry-disc shown in Fig. 2.
2. Remove Pry-disc from Wing Panel---with knife blade as shown in Fig. 3. Insert blade at rear, pry forward.
3. From inside of fireplace, push length of pipe gently through pry-disc hole until pipe comes up against soft insulation, with which the tube shield is packed. Push insulation to outside---save it for re-use.
4. When gas line has been completed to a point just outside fireplace, install a nipple having length suitable to device. Add cap unless device to be installed now. Repack insulation in Tube Shield as shown in Fig. 4.

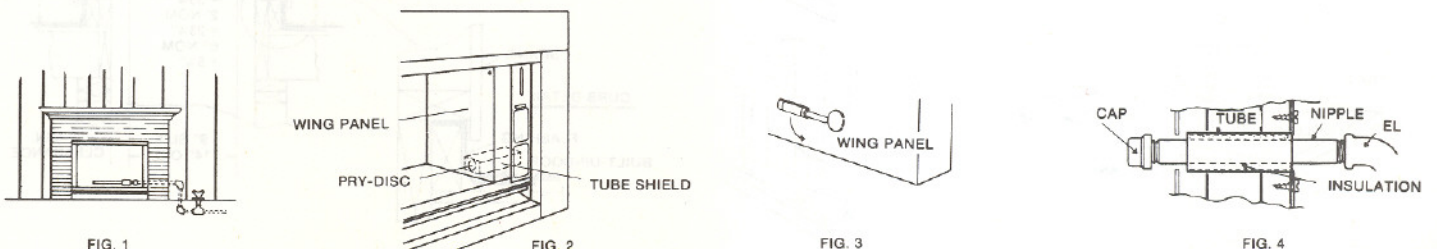

MARK 123 CHIMNEY TERMINAL CAP

9" Size---CAT. NO. 925



CAP WITH COVER



CHASE TOP

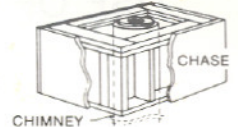

CHIMNEY

DEFINITIONS:

The **TERMINAL CAP** (Cat.No.925) is a factory-built chimney cap used to complete the Mark 700 Chimney, in conjunction with a locally-constructed **CHASE TOP** which is installed on top of the built-on-the-site **CHASE**. The **CAP** includes a Chimney Cover which protects the uppermost chimney top end.

The **CHASE TOP** is weatherproof, permanent cover, constructed locally (not supplied by Vega Industries, Inc.) to specifications shown herein, and installed on top of the **CHASE**. The **CHASE TOP**, normally metal, has a Collar of 2" height for each chimney which will be contained within the **CHASE** each Collar located accurately relative to each chimney.

The **CHASE** is a hollow vertical enclosure, constructed as a permanent part of the building. The **CHASE** may be relatively simple and small box-like construction for installation on a roof, as shown above--containing only the upper ends of chimneys. The **CHASE** however, may alternatively be located **outside** the general exterior walls of the building, be sized to contain one or more fireplaces as well as their chimneys, and be of a height which will satisfy the requirements of the building design and code requirements for chimney height-above-roof.

GENERAL INFORMATION

1. The **TERMINAL CAP** completes the upper end of the Mark 700 Chimney. The topmost Chimney Section **MUST** end within the 6" height range of the Terminal Cap collar, as shown in Fig. 1. (It is necessary to utilize 3', 2' and 6" Chimney Sections in appropriate quantity to insure that the topmost Chimney Section ends within this range.)
2. The **CHIMNEY SECTIONS** must be installed so as to maintain a 2" minimum clearance to combustible construction.
3. Most codes require that "a chimney should extend at least 3' above the highest point where it passes through the roof and at least 2' higher than any portion of a building within 10 ft." Consult local codes for requirements in your area. See also **HEIGHT**, next page.
4. The **CHASE TOP** is constructed as a flat, or contoured cover, of metal or other non-combustible material, with width and length to suit the Chase dimensions. Its outer edge must have a down-turned flange of not less than 2" height. Careful attention to collar size in Fig. 2 is recommended--note 2" collar height and collar diameter. (Detailed drawings for local fabrication of single or multiple chimney **CHASE TOPS** are available. Write for Vega Drawing Package #5.)

The fireplace may be installed directly on a combustible floor and the fireplace sides and rear may be in contact with combustible walls or wall framing members. **WARNING: PROVIDE COMPLETE FULL-AREA SUPPORT BENEATH FIREPLACE TO BEAR WEIGHT OF UNIT AND ITS CHIMNEY--DO NOT SUPPORT FIREPLACE AT A FEW POINTS ONLY WITH BLOCKS OR FLOOR JOINTS.** (To raise fireplace above floor, construct a sturdy platform with full wood covering.)

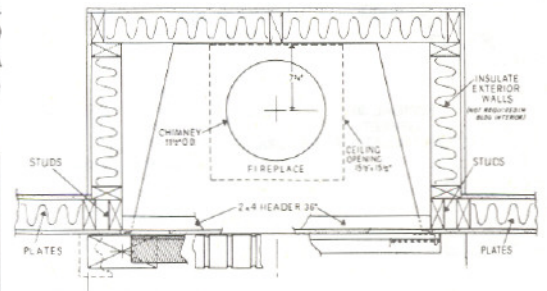

--- WARNING ---

These Directions (for **CHASE**, **CHASE TOP**, and **TERMINAL CAP**) have been carefully established to permit wide latitude in the employment of chase construction and location. However, safety and permanence demand adherence to **REQUIREMENTS** clearly stated herein and utilization of good materials installed with care.

ASSEMBLY AND CONSTRUCTION DETAILS

One typical installation is illustrated below. A Sketch, an End View and a Curb Detail define the methods used--in this instance, the **CHASE** is constructed of ordinary 2 x 4 lumber, covered with an exterior-grade sheathing material, and mounted on a typical curb for flat roof. One or several chimneys might be involved.

TERMINAL CAP is installed after Chimney Cover, (see at left). With Cap in position on Chase Top Collar, tighten the locking bolt on 8" Cap Collar. Install the two 1" screws supplied so that they penetrate Cap, Chase Top Collar and Chimney Section.

CHASE TOP normally of 24-ga. galvanized steel, or heavier, has collar and corners soldered watertight. Fasten by nailing down into Chase, using appropriate flashing nails with waterproof-sealed heads. There should be a slight crown built into large Chase Tops.

CURB DETAIL will vary for roof types and local practice. For sloped roof, or for installation straddling ridge, curb may be omitted and conventional flashing practice employed.

