

OLD
DISCONTINUED

FREE STANDING

imaginative fireplace charm

... a new era of self-expression

Crackling open fire has traditionally symbolized hospitality in the home. A good place to be together . . . where the hearth charms in imaginative ways.

For the individualistic taste of the modern, creative homemaker, Majestic Contemporary Fireplaces—the work of up-to-the-minute designers—add new zest and individually stylize the home of today.

COLORS . . . expressive shades reflecting vitality for living are decorator coordinated. Color samples, below, approximate either porcelain or enamel colors as are available for each model. Aztec colors are stippled with black.

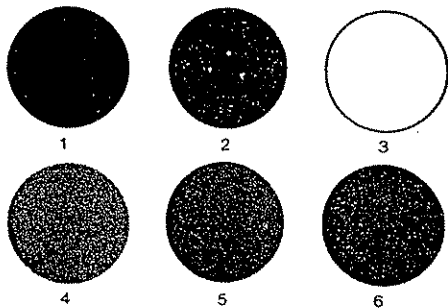

1 Matte Black
2 Mayan Red
3 White
4 Aztec Blue
5 Bronze Green
6 Orange Tone

*Specify color number after model number when ordering.

FUELS . . . authentic Wood-Burning or convenient, efficient Gas-Fired and Electric units assure a fireplace for everyone.

STYLES . . . various shapes, sizes and designs to highlight the full range of room motifs and permit installation most anywhere.

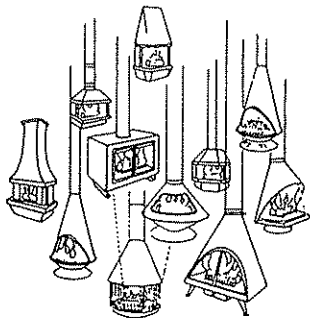

INSTALLATION . . . easy to install from hearth to chimney top with Majestic components.

Let your imagination run free . . . choose a Majestic Contemporary Fireplace to satisfy that irresistible urge toward self-expression in your home . . . house, apartment or cabin.

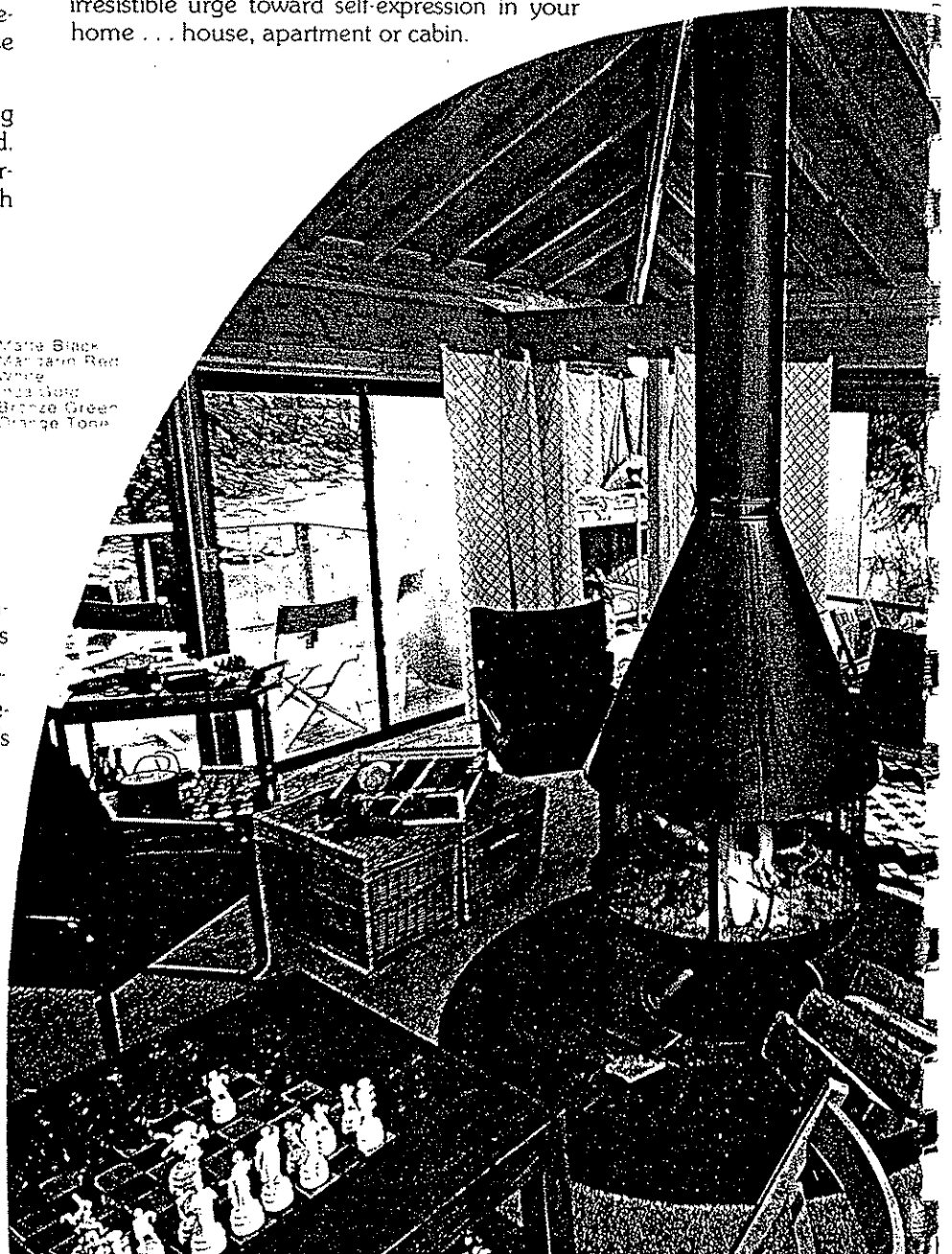



Majestic

Regency

exclusive ash drawer

This proven "pleaser" is quick-warming for full hearth-side enjoyment in any modern setting. Features the Majestic exclusive "SILENT BUTLER" ash drawer for easier, cleaner ash removal. This handy drawer, located directly below the hearth, collects ashes through an ash dump built into the firebrick hearth. Drawer top closes automatically when drawer is pulled out by handle. Drawer top opens when replaced in hearth. Available in all porcelain decorator colors or matte black. Basket grate and firebrick are installed at factory. Pre assembled fireplace is shipped with screens, universal adapter and matching pipe to accommodate an 8" ceiling installation (using a Majestic Chimney Base).

Your choice of an enclosed base or tripod legs adds to the variety of REGENCY installation possibilities.

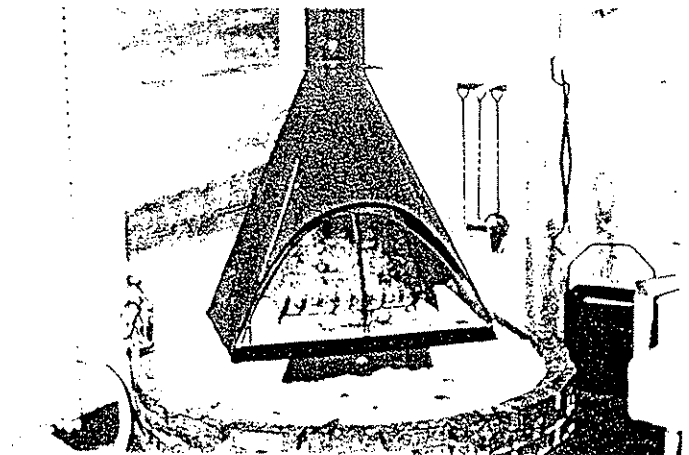
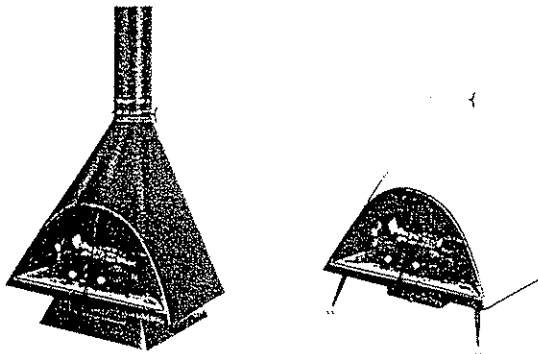
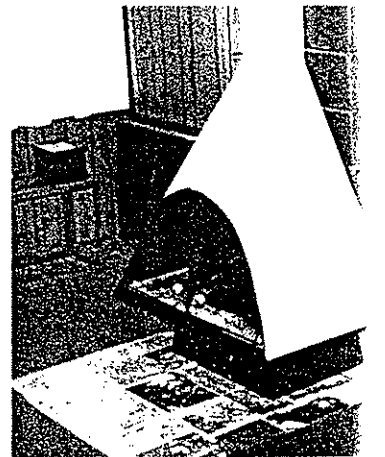
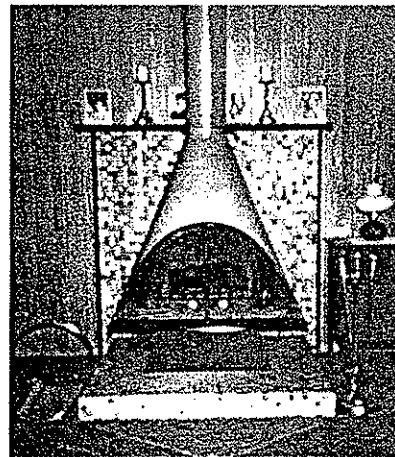
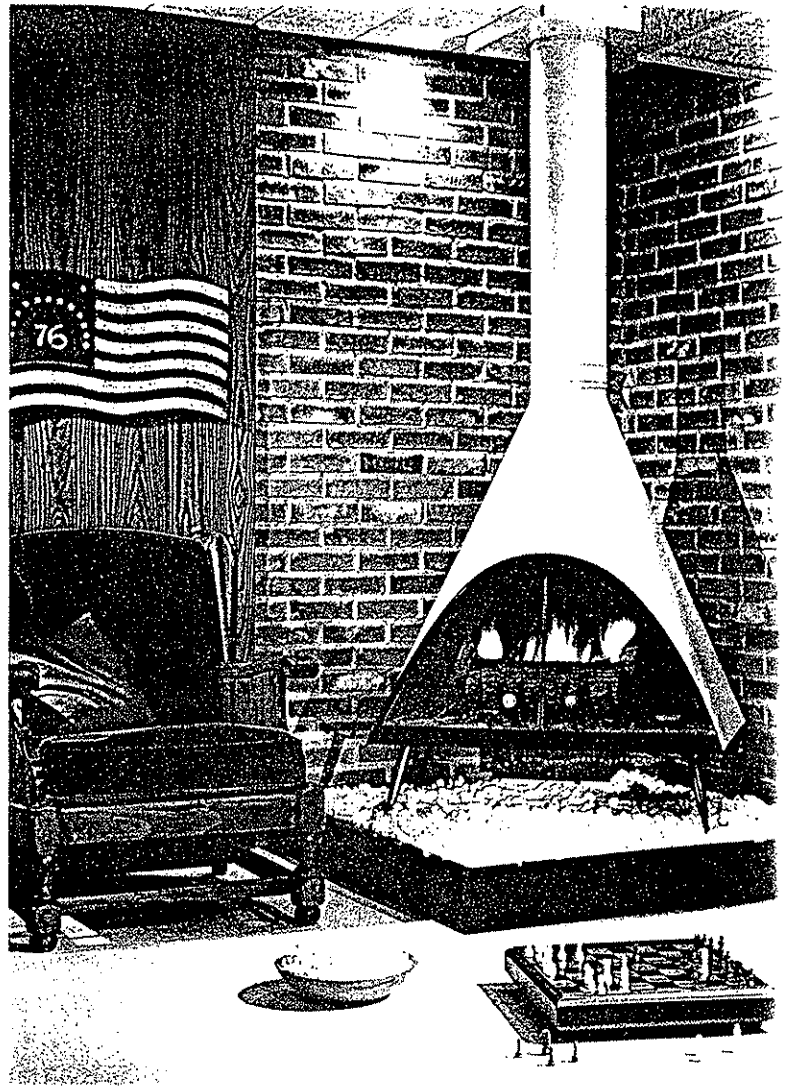

WOOD-BURNING Regency®

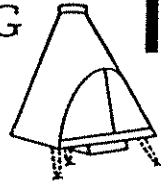

INSTALLATION INSTRUCTION

by **Majestic®**
An American-Standard Company

DIMENSIONS

MODEL	RFW36
A	8"
B	36"
C	45½"
D	9"
E	24⅞"
F	5½"
G	17¼"
Flush Ceiling Range	7" to 7'11"
Ceiling Range Using Majestic Base	7'4" to 8'3"

(Package will accommodate ceilings in this range.)

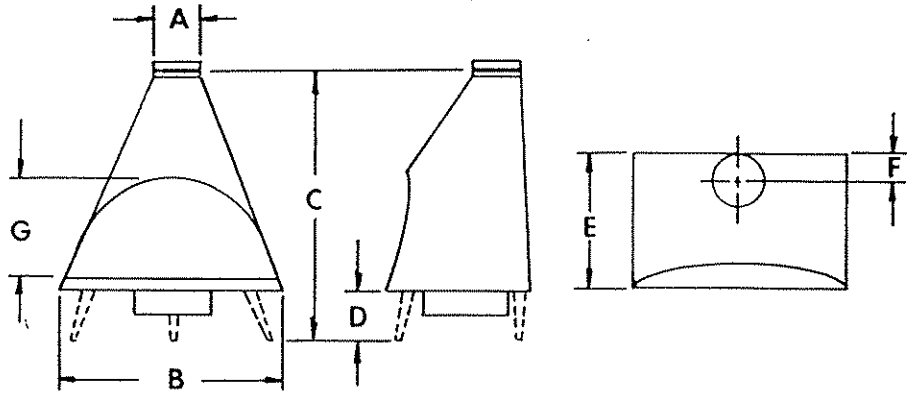

CLEARANCES

Before starting your installation, consult your applicable local code clearance requirements. The minimum clearances listed are most widely accepted nationally. The Regency Fireplaces are listed by:

Inter. Conf. Bldg. Off. No. 1581 So. Bldg. Code Cong. No. 7177-75 Bldg. Off. Code Admin. No. 71-21

Protective Floor Covering area required for all combustible floors. Suggested material, Slate, Stone, Ceramic Tile, Asbestos Board or equivalent non-combustible material at least ⅜" thick.

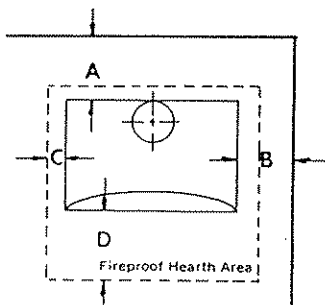

* NOTE: Due to the wide variances of non-combustibles recognized by building officials, these clearances are recommendations only.

CLEARANCES

TO COMBUSTIBLE WALLS		TO NON-COMBUSTIBLES MASONRY — STONE — BRICK — ETC.*
MODEL	RFW36	RFW36
A	24"	3"
B	18"	3"
C	7"	7"
D	18"	18"

NOTE: 18" clearance required from outer edge of Smoke Pipe to combustible wall or ceiling.

ASSEMBLY INSTRUCTIONS

(Contents of shipping cartons; preassembled fireplace, basket grate, screens, universal adapter, one 3' length of pipe—either CB enclosed base with bolts, or CL 3-leg package with bolts.)

1. Unpack and remove parts carefully from cartons. Porcelain finish is glass and should be treated as such. Any sharp blow or dropping porcelain parts on hard surface may chip the finish. The Matte Black painted finish is porous and will stain easily. Clean hands or protective paper should be used.

IMPORTANT

Do not remove clamp that holds basket grate and firebrick in place until fireplace is installed.

CB Enclosed Base Assembly

- a. Remove and discard cover plate for access for ash drawer. (This is used for gas model only.)
- b. Remove ash drawer from fireplace.
- c. Lay fireplace carefully on its back and fit base over Ash Drawer frame and align holes to bottom of fireplace.
- d. Attach with Hex Head Bolts

and draw up snug with nuts affixed in bottom of fireplace.

- e. Replace and test Ash Drawer for free operation.

CL Legs Assembly.

- a. Lay fireplace carefully on its back and attach the flat bracket leg to center rear with Hex Head Bolts and draw up snug with nuts affixed in bottom of fireplace.
 - b. Attach the two legs, that are similar, to front corners in like manner.
2. Place the fireplace in the desired location, aligning with the chimney projecting through the ceiling. Make sure floor protective material is in place beneath unit.
 3. Position smoke pipe, crimped end up, on fireplace. (On porcelain, a fine film of light grease, oil, vaseline, etc., will allow the joints to slide together easily.)
 4. Place universal adapter on top section of smoke pipe. Note! Large end of universal adapter fits over the outside of the smoke pipe.
 5. Slide universal adapter into chimney base.

6. Position smoke pipe and universal adapter assembly on adjacent smoke pipe section.

7. Check alignment of installation for appearance, double checking that all flue joints are seated properly.

8. To complete installation, remove clamp that holds basket grate and firebrick—remove protective covering from firebrick.

9. Before starting fire, place damper in open position (vertical) and push handle of Ash Drawer all the way in to allow ashes to drop through ash dump. Pulling handle out closes Ash Drawer for removal of ashes.

10. Always close screen after lighting fire.

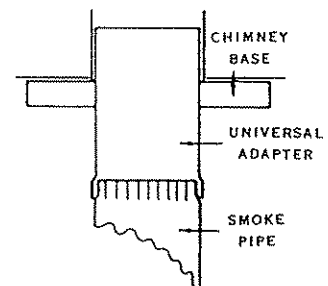

Regency®

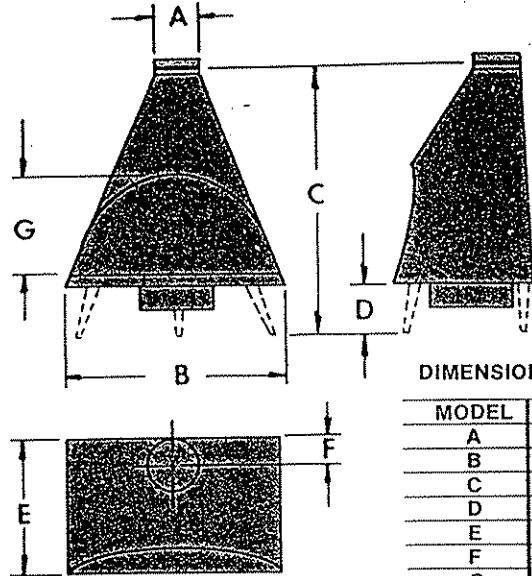

DIMENSIONS

MODEL	RFW36
A	8"
B	36"
C	45½"
D	9"
E	24⅞"
F	5½"
G	17¼"

FLUSH CEILING RANGE 7' TO 7'11"

CEILING RANGE USING MAJESTIC BASE 7'4" TO 8'3"

(Package will accommodate ceilings in this range.)

NOTE: Included with each unit package is one 3' length of pipe.



CLEARANCES

Before starting your installation, consult your applicable local code clearance requirements. The minimum clearances listed are most widely accepted nationally. The Regency Fireplaces are listed by:

- Inter. Conf. Bldg. Off. No. 1581
- So. Bldg. Code Cong. No. 7177-75
- Bldg. Off. Code Admin. No. 71-21

Protective Floor Covering area required for all combustible floors. Suggested material, ⅜" Asbestos Millboard or equivalent non-combustible material.

Regency Fireplaces are to be attached to a chimney suitable for use with residential type and building heating appliance chimney with equal flue size.

CLEARANCES

TO COMBUSTIBLE WALLS		TO NON-COMBUSTIBLE WALLS*
MODEL	RFW36	RFW36
W	24"	3"
X	18"	3"
Y	7"	7"
Z	18"	18"

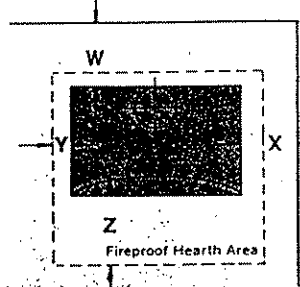

NOTE: 18" clearance required from outer edge of smoke pipe to combustible wall or ceiling.

*NOTE: Walls must be covered with ⅜" thick Asbestos Millboard or equivalent. Due to the wide variance of non-combustibles recognized by building officials, these clearances are recommendations only.

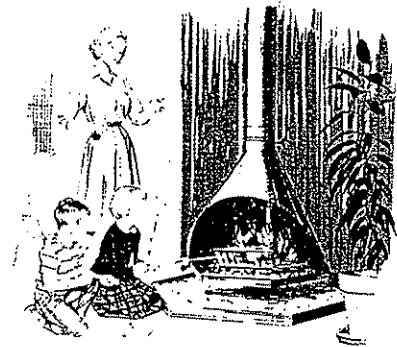
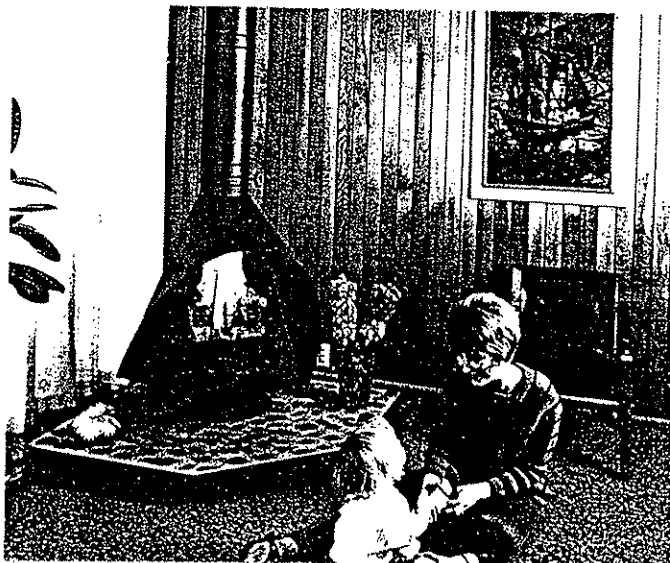
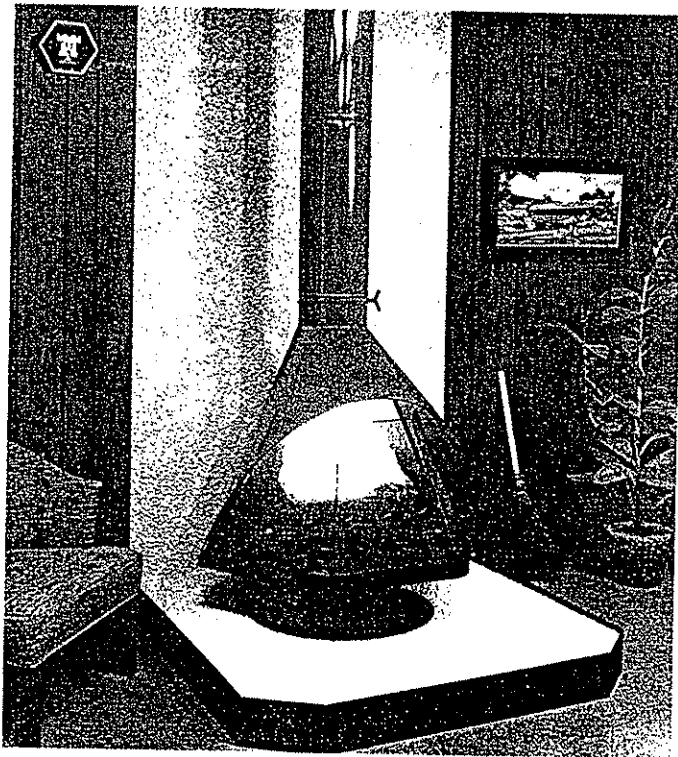
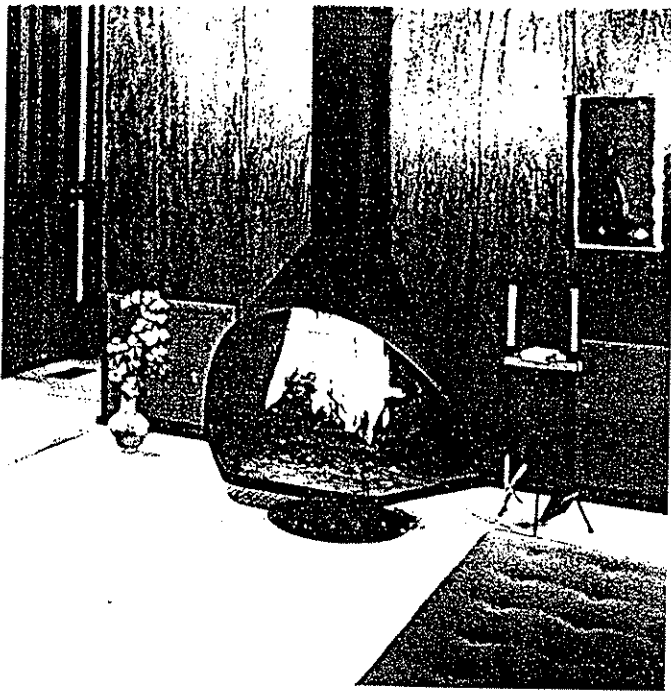

Majestic®

Firehood the original conical Wood-Burning Fireplace

Accepted as the trend-setter, the FIREHOOD is today's most popular free-standing fireplace. Coordinated geometric shapes in five sparkling porcelain colors, or the popular matte black, result in a dramatic and functional unit. The conical hood and slender stack combine readily with any decor in a new or existing home. Hearth and firebox opening are designed to permit full view of a crackling fire from most any room position. Two hearth sizes, 38" and 45", assure a FIREHOOD proportioned for any room. The 45" FIREHOOD is available in matte black only. Included with pre-assembled unit are screen, universal adapter, ready-mix refractory hearth material and enough matching pipe for an 8' ceiling (using a Majestic Chimney Base). Underwriters Laboratories, Inc. listed. Log basket grate optional equipment.

Firehood®



INSTALLATION INSTRUCTION

by **Majestic®**
An American-Standard Company

DIMENSIONS

MODEL	FFW38U	FFW45U
A	9"	10"
B	38"	45"
C	38 1/2"	50"
D	7 3/4"	7 3/4"
E	23 3/4"	23 3/4"
F	10"	10 1/2"
G	28"	34"
Flush Ceiling Range	7' 2 1/2" to 8' 1 1/2"	7' 4 1/2" to 8' 3 1/2"
Ceiling Range Using Majestic Base	7' 6 1/2" to 8' 5 1/2"	7' 8 1/2" to 8' 7 1/2"

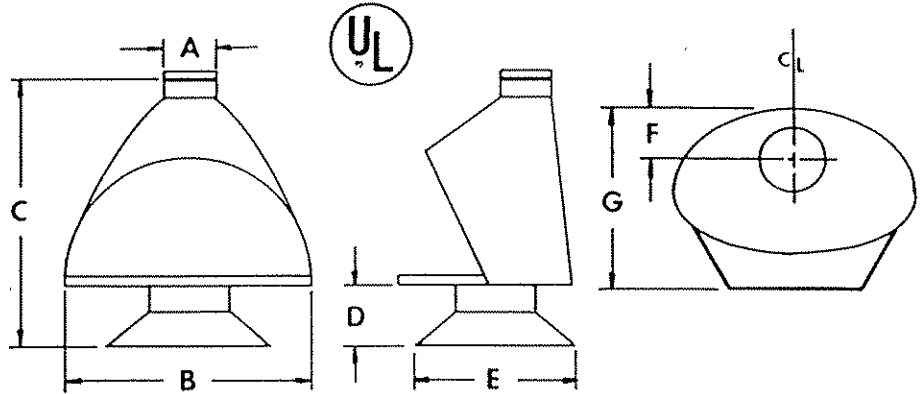

(Package will accommodate ceilings in this range.)

CLEARANCES

Before starting your installation, consult your applicable local code clearance requirements. The minimum clearances listed are most widely accepted nationally. The Firehood Fireplaces are listed by the following building codes:

Inter Conf. Bldg. Off. No. 1581 So. Bldg. Code Cong. No. 7177-75 Bldg. Off. Code Admin. No. 71-21

Protective Floor Covering area required for all combustible floors. Suggested material, 3/8" Asbestos Millboard or equivalent non-combustible material.

Firehood Fireplaces are to be attached to a chimney suitable for use with residential type and building heating appliance chimney with equal flue size.

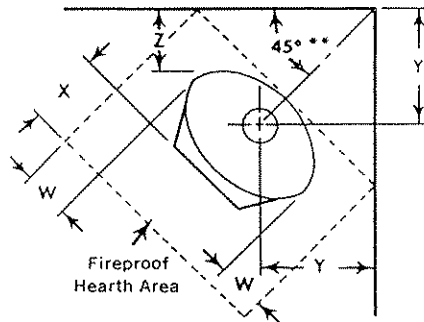
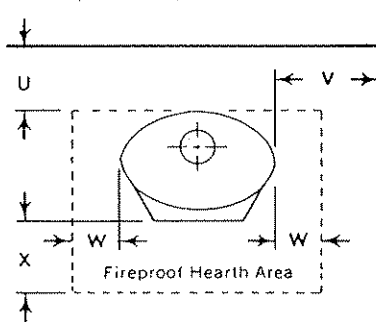

*Walls must be covered with 3/8" thick Asbestos Millboard or equivalent. Due to the wide variance of non-combustibles recognized by building officials, these clearances are recommendations only.

**Dimension 'Z' must equal 'V' if angle is less than 45°.

CLEARANCES

MODEL	TO COMBUSTIBLE WALLS		TO NON-COMBUSTIBLE WALLS*	
	FFW38U	FFW45U	FFW38U	FFW45U
U	16"	16"	4"	4"
V	26"	36"	16"	24"
W	12"	12"	12"	12"
X	18"	20"	18"	20"
Y	29"	31"	17"	19"
Z**	16"	16"	4"	4"

NOTE: 18" clearance required from outer edge of Smoke Pipe to combustible wall or ceiling

ASSEMBLY INSTRUCTIONS

(Contents of shipping carton: pre-assembled fireplace, screen, universal adapter—two 2' lengths pipe for FFW38U—one 3' length pipe for FFW45U—bag of ready-mix hearth material.)

1. Unpack and remove parts carefully from carton. Porcelain finish is glass and should be treated as such. Any sharp blow or dropping porcelain parts on hard surface may chip the finish. The Matte Black painted finish is porous and will stain easily. Clean hands or protective paper should be used.
2. Place the Fireplace in the desired location, aligning with the chimney projecting through the ceiling. Make sure floor protective material is in place beneath unit.
3. Position one smoke pipe, crimped end up, on fireplace. (On porcelain, a fine film of light grease, oil, vaseline, etc., will allow the joints to slide together easily.)

4. Universal adapter goes on top section of second smoke pipe. Note! Large end of universal adapter fits over the outside of the smoke pipe.
5. Slide universal adapter into Chimney base.
6. Position smoke pipe and universal adapter assembly on adjacent smoke pipe section.
7. Check alignment of installation for appearance, double checking that all flue joints are seated properly.
8. Three holes are provided in fireplace base if it is desirable to secure unit to floor.
9. Mix hearth refractory according to instructions and trowel into place in the hearth. (Pour over mineral fiber insulation.) Allow to dry at least 72 hours before building a fire or setting any object on hearth. Your first fire should be quite small, and not allowed to get too hot to allow for the final curing of the hearth material.

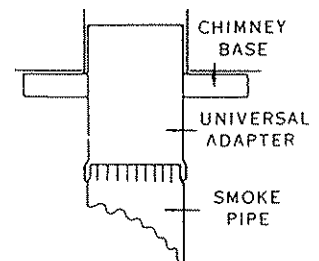

10. Always replace the screen after lighting fire.

Firehood®

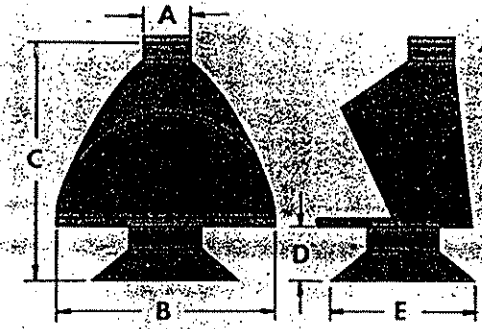

DIMENSIONS

MODEL	FFW38U	FFW45U
A	9"	10"
B	38"	45"
C	38½"	50"
D	7¾"	7¾"
E	23¾"	23¾"
F	10"	10½"
G	28"	34"

FLUSH CEILING RANGE	7'2½" TO 8'1½"	7'4½" TO 8'3½"
CEILING RANGE USING MAJESTIC BASE	7'6½" TO 8'5½"	7'8½" TO 8'7½"

(Package will accommodate ceilings in this range.)

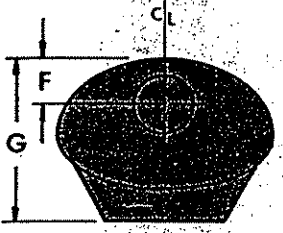

NOTE: Included with each unit package is two 2' lengths of pipe for FFW38U, — one 3' length of pipe for FFW45U.

DATA SPECS

CLEARANCES

Before starting your installation, consult your applicable local code clearance requirements. The minimum clearances listed are most widely accepted nationally. The Firehood Fireplaces are listed by:

- Inter. Conf. Bldg. Off. No. 1581
- So. Bldg. Code Cong. No. 7177-75
- Bldg. Off. Code Admin. No. 71-21

Protective Floor Covering area required for all combustible floors. Suggested material, ⅝" Asbestos Millboard or equivalent.

Firehood Fireplaces are to be attached to a chimney suitable for use with residential type and building heating appliance chimney with equal flue size.

CLEARANCES

MODEL	TO COMBUSTIBLE WALLS		TO NON-COMBUSTIBLE WALLS*	
	FFW38U	FFW45U	FFW38U	FFW45U
U	16"	16"	4"	4"
V	26"	36"	16"	24"
W	12"	12"	12"	12"
X	18"	20"	18"	20"
Y	29"	31"	17"	19"
Z	16"	16"	4"	4"

*NOTE: Walls must be covered with ⅝" thick Asbestos Millboard or equivalent. Due to the wide variance of non-combustibles recognized by building officials, these clearances are recommendations only.

**NOTE: Dimension 'Z' must equal 'V' if angle is less than 45°.

NOTE: 18" clearance required from outer edge of smoke pipe to combustible wall or ceiling.

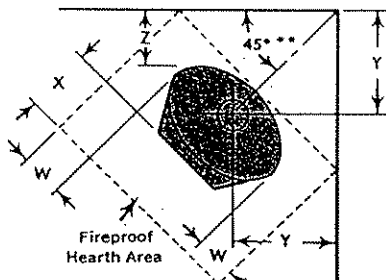
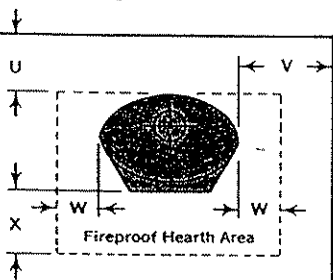

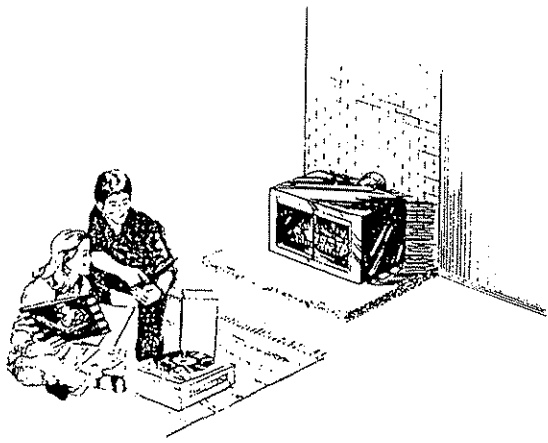

Majestic®

Manchester-Pierce

*a new dimension
in fireplaces*

Crisp, clean, straight-line styling plus double insulated wall construction, steel hearth, and full 28" x 16" screened opening, provide modern versatility with the ageless cheer of a wood-burning fireplace. The heavy-duty MANCHESTER-PIERCE has the same location flexibility as a piece of furniture. Available in the popular matte black finish only. Included with pre-assembled fireplace are screens, universal adapter and matte black pipe to install to an 8' ceiling (using a Majestic Chimney Base). Log basket grate optional equipment.

rear outlet . . .

Additional room locations and decorator effects are achieved by the installation of the rear flue model. Where vertical venting is not preferred or possible, the MANCHESTER-PIERCE may be vented through a wall, using Majestic's chimney tee and chimney system. Simply position on a suitable hearth and instantly create the coziness and warmth of a wood-burning fire. Log basket grate optional equipment.

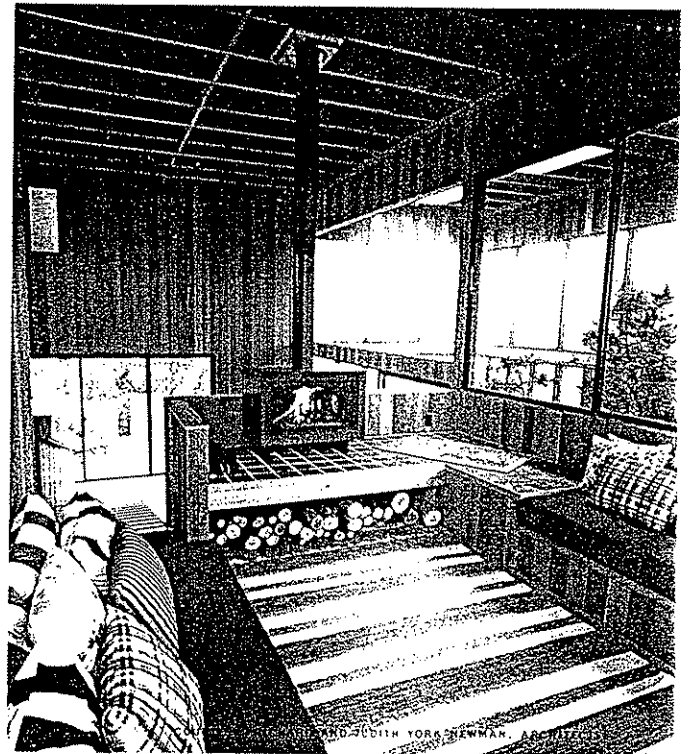

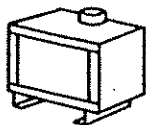

DIMENSIONS

MODEL	MPW34T	MPW34R
A	7"	7"
B	34"	34"
C	26¾"	26¾"
D	5"	5"
E	21¾"	21¾"
F	10"	21½"
G	16"	16"
H	28¼"	28¼"
Flush Ceiling Range	7'1¾" to 8'¾"	---
Ceiling Range Using Majestic Base	7'5¾" to 8'4¾"	---

(Package will accommodate ceilings in this range.)

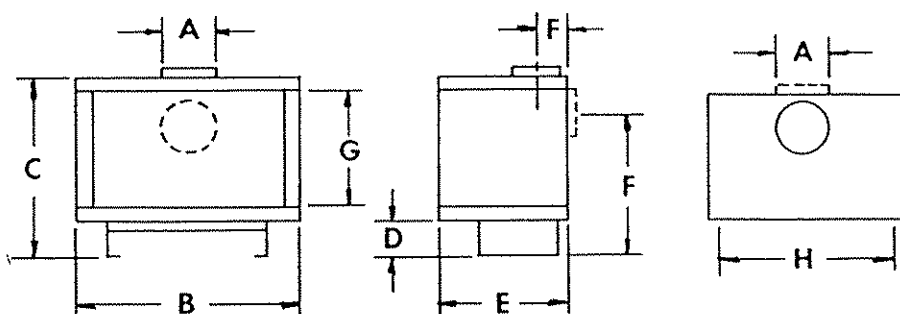

CLEARANCES

Before starting your installation, consult your applicable local code clearance requirements. The minimum clearances listed are most widely accepted nationally. The Manchester-Pierce Fireplaces are listed by:

Inter. Conf. Bldg. Off. No. 1581 So. Bldg. Code Cong. No. 7177-75 Bldg. Off. Code Admin. No. 71-21

Protective Floor Covering area required for all combustible floors. Suggested material, Slate, Stone, Ceramic Tile, Asbestos Board or equivalent non-combustible material at least ¾" thick.

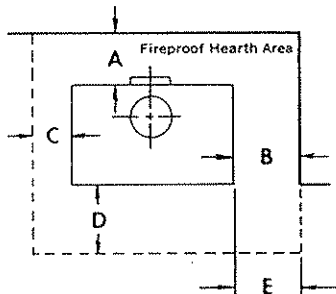

* NOTE: Due to the wide variances of non-combustibles recognized by building officials, these clearances are recommendations only.

† (When sidewall extends beyond unit)

CLEARANCES

MODEL	TO COMBUSTIBLE WALLS		TO NON-COMBUSTIBLES MASONRY — STONE — BRICK — ETC.*	
	MPW34T	MPW34R	MPW34T	MPW34R
A	13½"	18"	5"	5"
B	5"	5"	5"	5"
C	12"	12"	12"	12"
D	18"	18"	18"	18"
E†	48"	48"	---	---

NOTE: 18" clearance required from outer edge of Smoke Pipe to combustible wall or ceiling.

ASSEMBLY INSTRUCTIONS

(Contents of shipping carton: pre-assembled fireplace, screen, universal adapter, one 2' and one 3' length of pipes for MPW34T only; pre-assembled fireplace with screen for MPW34R only.)

1. Unpack your Manchester-Pierce fireplace carefully to avoid scratches to the finish. The Matte Black painted finish is porous and will stain easily. Clean hands or protective paper should be used.
2. Place the Fireplace in the desired location, aligning with the chimney. Do not fasten unit to the floor until installation is complete. Make sure floor protective material is in place beneath unit.

— For Top Vent Units —

3. Position one smoke pipe, crimped end up, on fireplace.
4. Place universal adapter on top section of second smoke pipe. Note! Large end of universal adapter fits over the outside of the smoke pipe.
5. Slide universal adapter into chimney base.
6. Position smoke pipe and universal adapter assembly on adjacent smoke pipe section.
7. Check alignment of installation for appearance, double checking that all flue joints are seated properly.
8. To complete installation, secure unit to floor using screws or lag screws.
9. Always close screen after lighting fire.

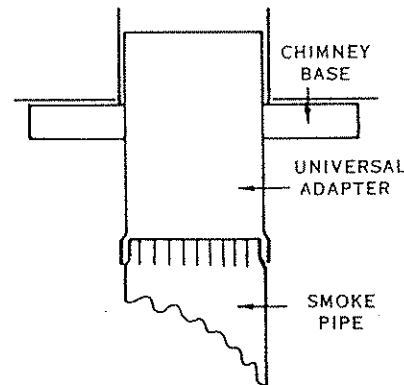

Manchester-Pierce®

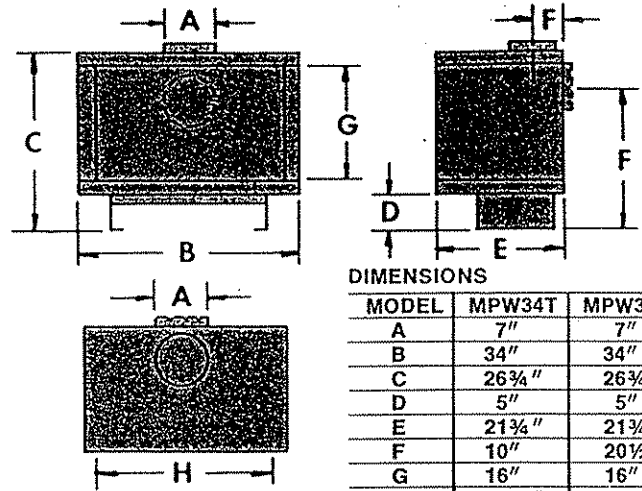

DIMENSIONS

MODEL	MPW34T	MPW34R
A	7"	7"
B	34"	34"
C	26 $\frac{3}{4}$ "	26 $\frac{3}{4}$ "
D	5"	5"
E	21 $\frac{3}{4}$ "	21 $\frac{3}{4}$ "
F	10"	20 $\frac{1}{2}$ "
G	16"	16"
H	28 $\frac{1}{4}$ "	28 $\frac{1}{4}$ "

NOTE: Included with each unit package is one 2' and one 3' lengths of black pipe for MPW34T only.

FLUSH CEILING RANGE	7'1 $\frac{3}{4}$ " TO 8'3 $\frac{3}{4}$ "	—
CEILING RANGE USING MAJESTIC BASE	7'5 $\frac{3}{4}$ " TO 8'4 $\frac{3}{4}$ "	—

(Package will accommodate ceilings in this range.)

DATA SPECS

CLEARANCES

Before starting your installation, consult your applicable local code clearance requirements. The minimum clearances listed are most widely accepted nationally. The Manchester-Pierce Fireplaces are listed by:

Inter. Conf. Bldg. Off. No. 1581
 So. Bldg. Code Cong. No. 7177-75
 Bldg. Off. Code Admin. No. 71-21

Protective floor covering area required for all combustible floors. Suggested material, $\frac{3}{8}$ " Asbestos Millboard or equivalent.

Manchester-Pierce Fireplaces are to be attached to a chimney suitable for use with residential type and building heating appliance chimney with equal flue size.

CLEARANCES

MODEL	TO COMBUSTIBLE WALLS		TO NON-COMBUSTIBLE WALLS*	
	MPW34T	MPW34R	MPW34T	MPW34R
V	13 $\frac{1}{2}$ "	18"	5"	5"
W	5"	5"	5"	5"
X	12"	12"	12"	12"
Y	18"	18"	18"	18"
Z†	48"	48"	—	—

†(When sidewall extends beyond unit)

*NOTE: Walls must be covered with $\frac{3}{8}$ " thick Asbestos Millboard or equivalent. Due to the wide variance of non-combustibles recognized by building officials, these clearances are recommendations only.

NOTE: 18" clearance required from outer edge of smoke pipe to combustible wall or ceiling.

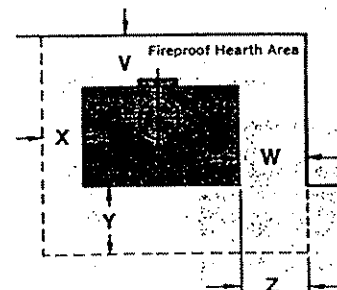

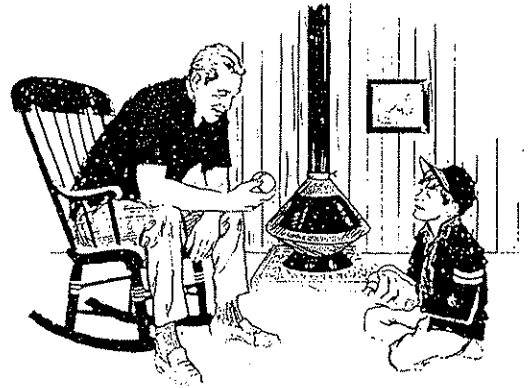
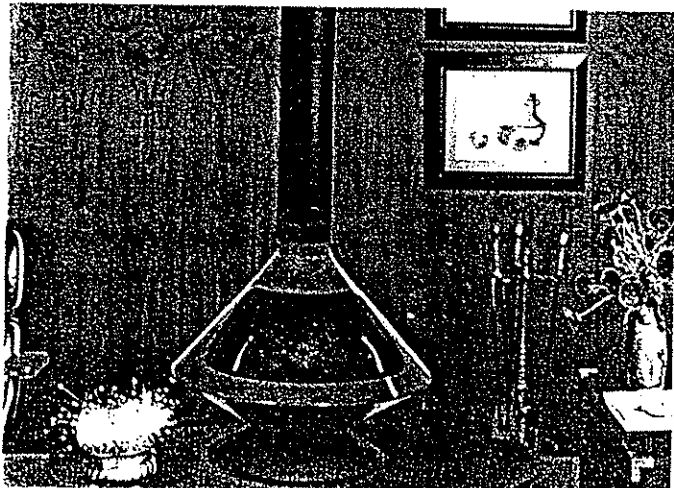
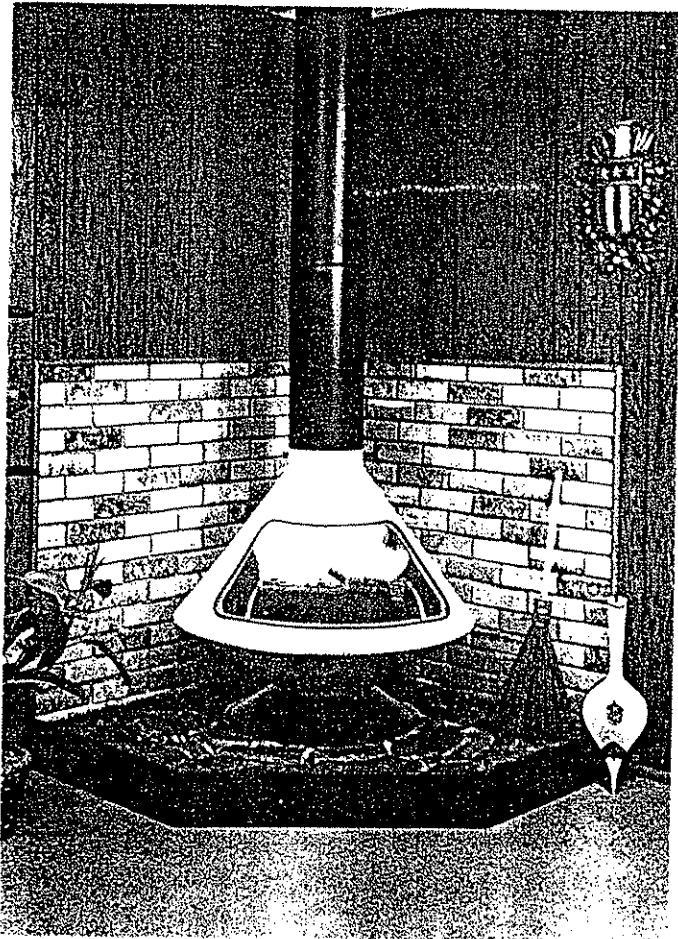
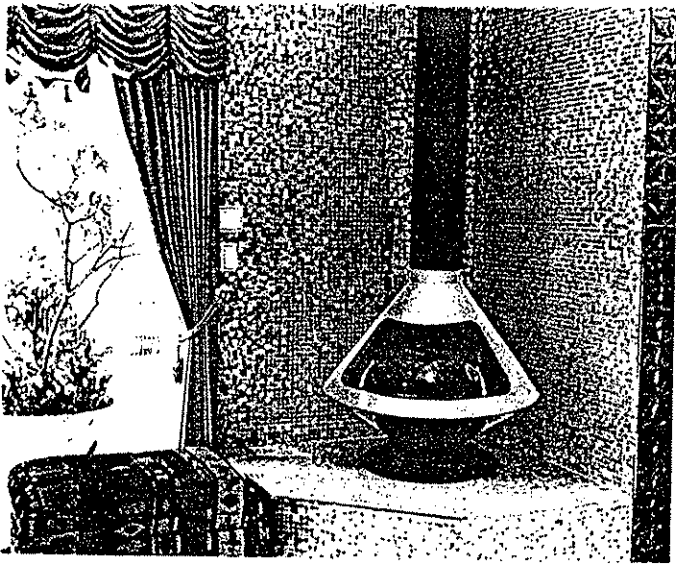

Majestic®

Aztec

*a dramatic concept in a
Wood-Burning Fireplace*

The AZTEC represents a new era in fireplace design. The totally different and universally unique creation provides a dramatic effect in any room location. All matte black or colorful stippled porcelain-finished fire chamber, accentuated by a matte black spun steel base and vertical flue, offers truly unusual beauty. One-piece, removable screen permits ready access to firebox in either 32" or 36" diameter version. Double-wall construction requires no refractory hearth. Screen, universal adapter and matte black pipe for an 8' ceiling included with unit (using a Majestic Chimney Base). Log basket grate optional equipment. Underwriters Laboratories, Inc. listed.

All AZTEC colors are stippled as shown in this same-size photo.

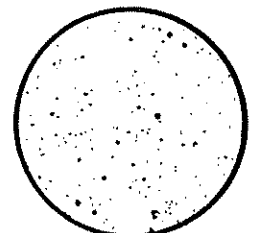

Aztec®

INSTALLATION INSTRUCTION



by **Majestic®**
An American-Standard Company

DIMENSIONS

MODEL	AZT32	AZT36
A	7"	9"
B	32"	36"
C	28"	33½"
D	4"	4"
E	24"	24"
F	8"	9½"
G	22"	25"
Flush Ceiling Range	7'5" to 8'4"	6'10½" to 7'9½"
Ceiling Range Using Majestic Base	7'9" to 8'8"	7'2½" to 8'1½"

(Package will accommodate ceilings in this range.)

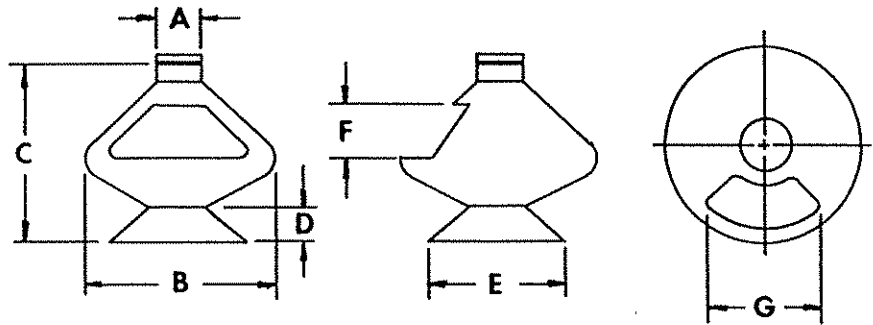

CLEARANCES

Before starting your installation, consult your applicable local code clearance requirements. The minimum clearances listed are most widely accepted nationally. The Aztec Fireplaces are listed by:

Inter. Conf. Bldg. Off. No. 1581 So. Bldg. Code Cong. No. 7177-75 Bldg. Off. Code Admin. No. 71-21
Protective Floor Covering area required for all combustible floors. Suggested material, Slate, Stone, Ceramic Tile, Asbestos Board or equivalent non-combustible material at least ¾" thick.

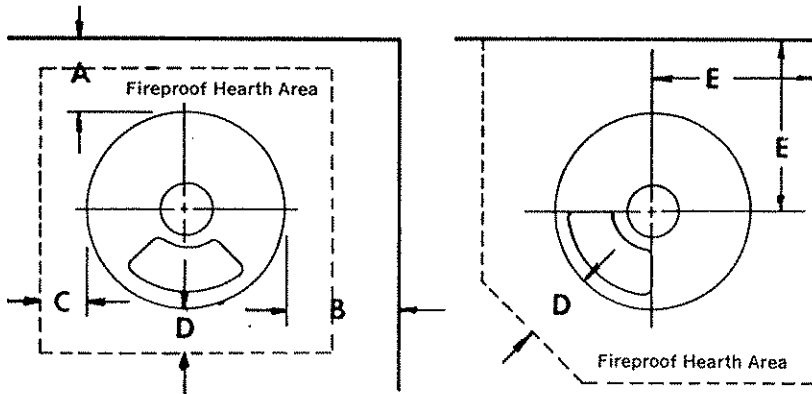

* NOTE: Due to the wide variances of non-combustibles recognized by building officials, these clearances are recommendations only.

CLEARANCES

MODEL	TO COMBUSTIBLE WALLS		TO NON-COMBUSTIBLES MASONRY— STONE— BRICK—ETC.*	
	AZT32	AZT36	AZT32	AZT36
A	5½"	4½"	4"	4"
B	27"	12½"	6"	6"
C	12"	12"	12"	12"
D	18"	18"	18"	18"
E	21½"	22½"	20"	22"

NOTE: 18" clearance required from outer edge of Smoke Pipe to combustible wall or ceiling.

ASSEMBLY INSTRUCTIONS

(Contents of shipping carton: pre-assembled fireplace, screen, universal adapter, one 2' and one 3' length of pipe for AZT32 shipped from Huntington; or two 2½' length of pipe for AZT32 shipped from Lynwood; or, two 2' length of pipe for AZT36. AZT36 package same from Huntington or Lynwood.)

1. Unpack and remove parts carefully from carton. Porcelain finish is glass and should be treated as such. Any sharp blow or dropping porcelain parts on hard surface may chip the finish. The Matte Black painted finish is porous and will stain easily. Clean hands or protective paper should be used.
2. Place the Fireplace in the desired location, aligning with the chimney projecting through the ceiling. Do not

fasten unit to the floor until installation is complete. Make sure floor protective material is in place beneath unit.

3. Position one smoke pipe, crimped end up, on fireplace.
4. Place universal adapter on top section of second smoke pipe. Note! Large end of universal adapter fits over the outside of the smoke pipe.
5. Slide universal adapter into chimney base.
6. Position smoke pipe and universal adapter assembly on adjacent smoke pipe section.
7. Check alignment of installation for appearance, double checking that all flue joints are seated properly.
8. To complete installation, secure unit to floor using screws or lag screws.
9. Always replace screen after lighting fire.

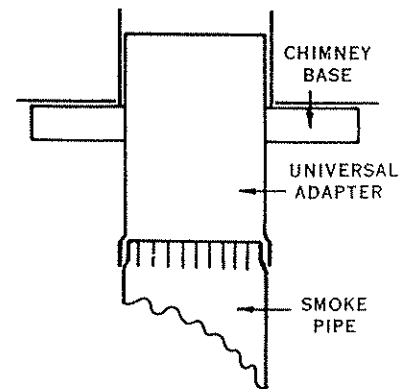



DIMENSIONS

MODEL	AZT32U	AZT36U
A	7"	9"
B	32"	36"
C	28"	33½"
D	4"	4"
E	23½"	23½"
F	8"	9½"
G	22"	25"
Flush Ceiling Range	7'5" to 8'4"	6'10½" to 7'9½"
Ceiling Range Using Majestic Base	7'9" to 8'8"	7'2½" to 8'1½"

(Package will accommodate ceilings in this range.)

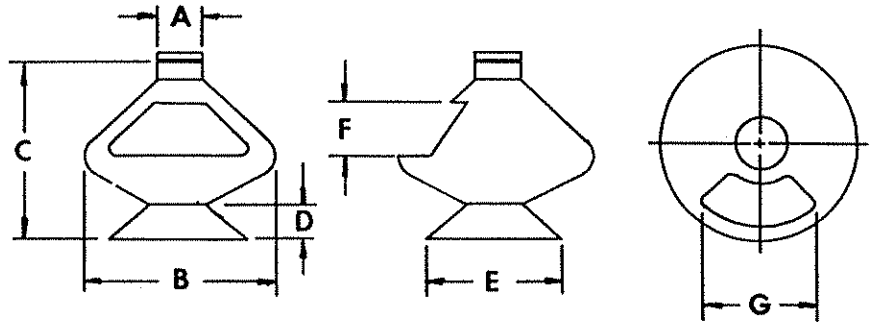

CLEARANCES

Before starting your installation, consult your applicable local code clearance requirements. The minimum clearances listed are most widely accepted nationally. The Aztec Fireplaces are listed by the following building codes:

Inter Conf. Bldg. Off. No. 1581

So. Bldg. Code Cong. No. 7177-75

Bldg. Off. Code Admin. No. 71-21

Protective Floor Covering area required for all combustible floors. Suggested material, 3/8" Asbestos Millboard or equivalent non-combustible material.

Aztec Fireplaces are to be attached to a chimney suitable for use with residential type and building heating appliance chimney with equal flue size.

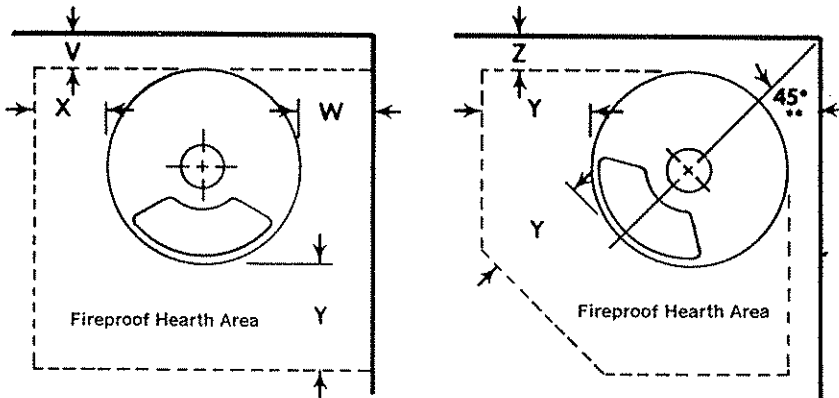

*Walls must be covered with 3/8" thick Asbestos Millboard or equivalent. Due to the wide variance of non-combustibles recognized by building officials, these clearances are recommendations only.

**Dimension 'Z' must equal 'W' if angle is less than 45°.

CLEARANCES

MODEL	TO COMBUSTIBLE WALLS		TO NON-COMBUSTIBLE WALLS*	
	AZT32U	AZT36U	AZT32U	AZT36U
V	5½"	4½"	4"	4"
W	12"	12"	6"	6"
X	12"	12"	12"	12"
Y	18"	18"	18"	18"
Z**	5½"	4½"	4"	4"

NOTE: 18" clearance required from outer edge of Smoke Pipe to combustible wall or ceiling.

ASSEMBLY INSTRUCTIONS

(Contents of shipping carton: pre-assembled fireplace, screen, universal adapter, one 2' and one 3' length of pipe for AZT32U; or, two 2' length of pipe for AZT36U)

- Unpack and remove parts carefully from carton. Porcelain finish is glass and should be treated as such. Any sharp blow or dropping porcelain parts on hard surface may chip the finish. The Matte Black painted finish is porous and will stain easily. Clean hands or protective paper should be used.
- Place the Fireplace in the desired location, aligning with the chimney base projecting through the ceiling. Make sure floor protective material is in place beneath unit.
- Position one smoke pipe, crimped end up,
- Universal adapter goes on top section of second smoke pipe. Note! Large end of universal adapter fits over the outside of the smoke pipe.
- Slide universal adapter up into Chimney base.
- Position second Smoke Pipe section onto Smoke Pipe on fireplace.
- Lower Universal Adapter onto Smoke Pipe.
- Check alignment of installation for appearance, double checking that all flue joints are sealed properly.
- Three holes are provided in fireplace base if it is desirable to secure unit to floor.
- Always replace the screen after lighting fire.

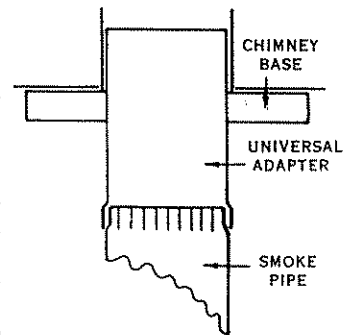

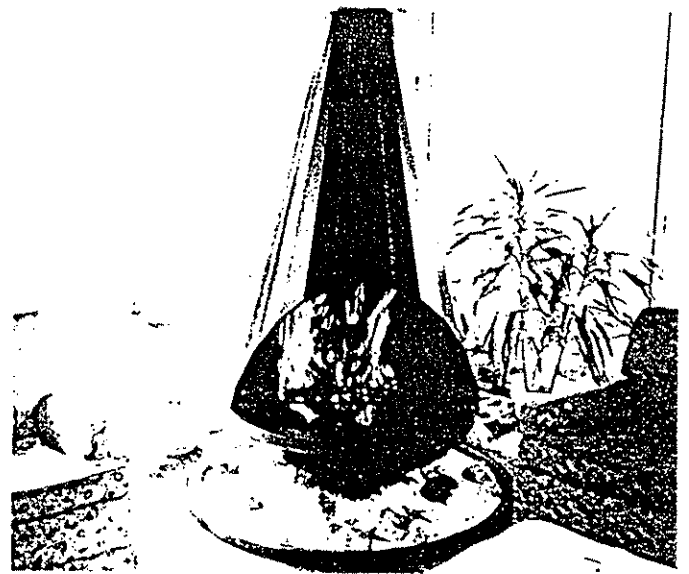
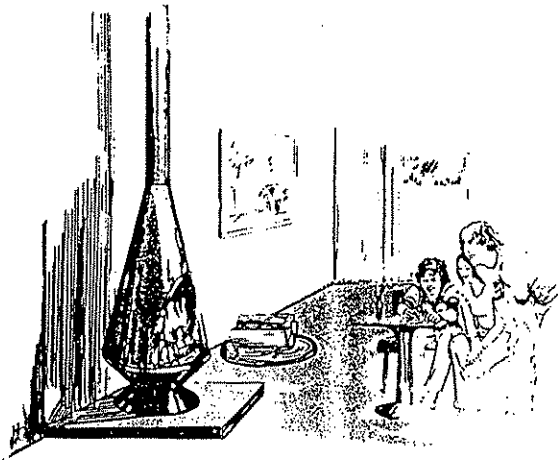

Majestic®

Jupiter

a decorator's delight

A cone-shaped wood-burner available in three sizes to fit any room or budget. Requiring minimum floor space in relation to hearth size, the JUPITER of unusual sleek design becomes the focal point of any room in which it is installed.

The 24" and 30" models, available in a choice of porcelain finishes or matte black, feature hoods of artistic modern curves, while the 38" model is matte black and utilizes a converging cone effect hood. Black mesh fire screens are factory-installed and permit ready access to the firebox. Pleasing and harmonious with either traditional or modern decor, the professional or do-it-yourself decorator can select a JUPITER that is just right. Included with each unit are screen, universal adapter, removable hearth material and matching pipe for an 8" ceiling (using a Majestic Chimney Base). Log basket grate optional equipment.

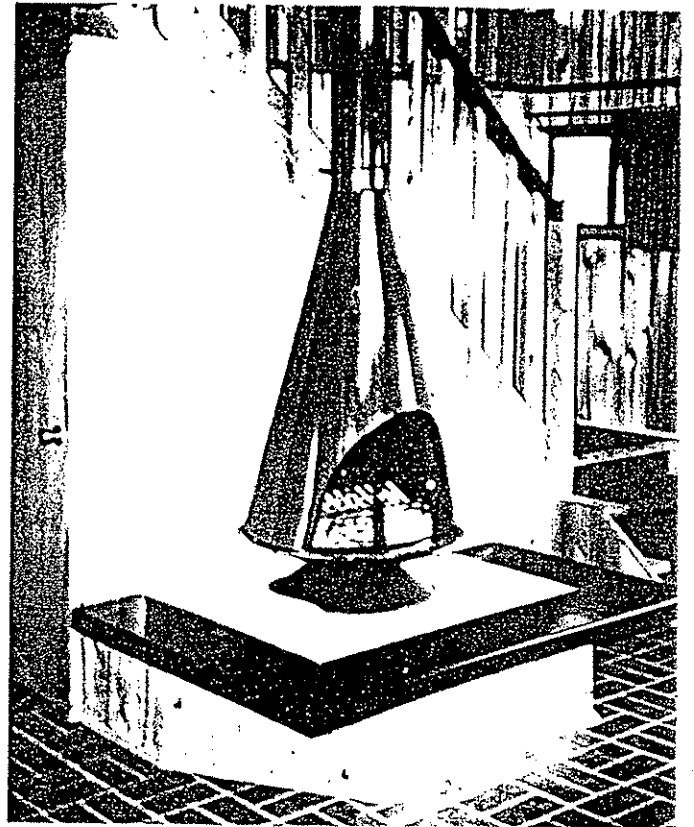

PORCELAIN
FINISHED
24" and 30"
Jupiter

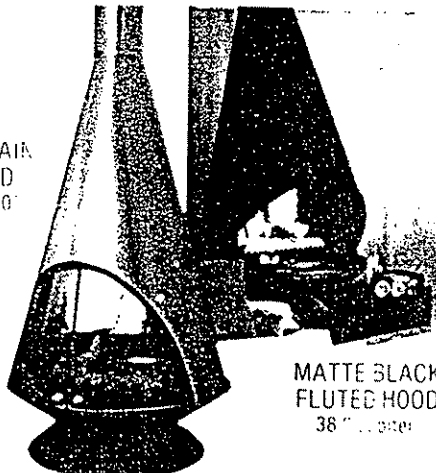

MATTE BLACK
FLUTED HOOD
38" Jupiter

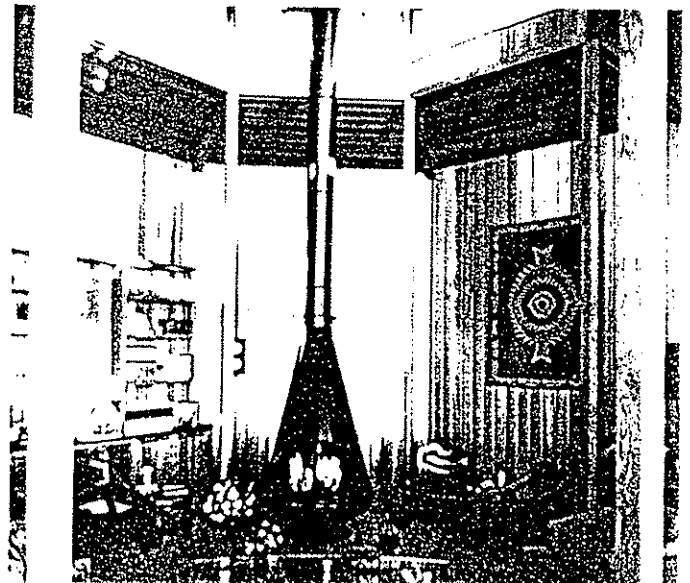

Jupiter®



INSTALLATION INSTRUCTION

by **Majestic®**
An American-Standard Company

DIMENSIONS

MODEL	JFW24	JFW30	JFW38
A	7"	7"	10"
B	24"	30"	38"
C	43 ¹ / ₄ "	56"	77"
D	8"	8"	13 ³ / ₄ "
E	18 ¹ / ₄ "	24"	24"
F	12"	15"	11 ³ / ₄ "
G	15"	17"	21"
Flush Ceiling Range	6'9" to 7'8"	6'10 ¹ / ₂ " to 7'9 ¹ / ₂ "	7'7 ¹ / ₂ " to 8'6 ¹ / ₂ "
Ceiling Range Using Majestic Base	7'1" to 8'	7'2 ¹ / ₂ " to 8'1 ¹ / ₂ "	7'11 ¹ / ₂ " to 8'10 ¹ / ₂ "

(Package will accommodate ceilings in this range.)

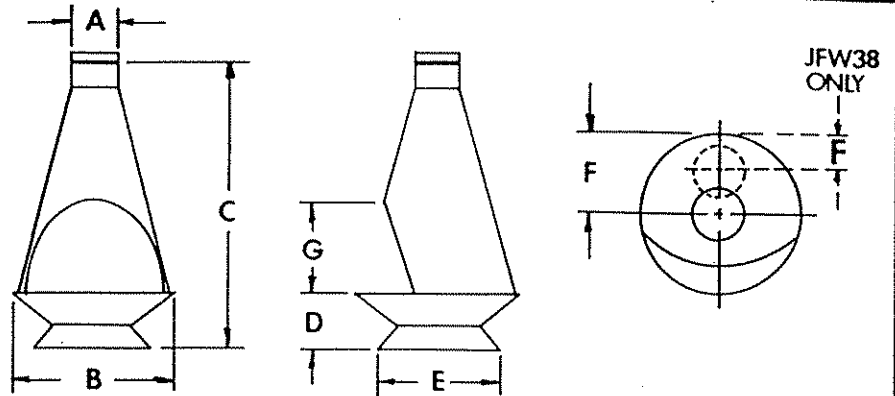

CLEARANCES

Before starting your installation, consult your applicable local code clearance requirements. The minimum clearances listed are most widely accepted nationally. The Jupiter Fireplaces are listed by:

Inter. Conf. Bldg. Off. No. 1581 So. Bldg. Code Cong. No. 7177-75 Bldg. Off. Code Admin. No. 71-21

Protective Floor Covering area required for all combustible floors. Suggested material, Slate, Stone, Ceramic Tile, Asbestos Board or equivalent non-combustible material at least 3/8" thick.

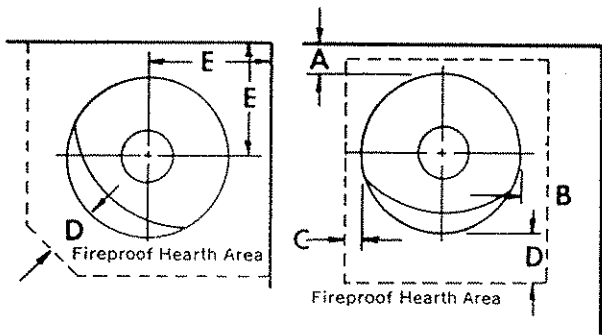

* NOTE: Due to the wide variances of non-combustibles recognized by building officials, these clearances are recommendations only.

CLEARANCES

MODEL	TO COMBUSTIBLE WALLS			NON-COMBUSTIBLES MASONRY—STONE— BRICK—ETC.*		
	JFW24	JFW30	JFW38	JFW24	JFW30	JFW38
A	18"	18"	18"	4"	4"	4"
B	30"	30"	30"	7"	7"	7"
C	18"	18"	18"	18"	18"	18"
D	18"	18"	18"	18"	18"	18"
E	30"	33"	32"	16"	19"	18"

NOTE: 18" clearance required from outer edge of Smoke Pipe to combustible wall or ceiling.

ASSEMBLY INSTRUCTIONS

(Contents of shipping carton: pre-assembled fireplace, screen, universal adapter, and, one 1' and one 2' lengths of pipe for JFW24; one 2' pipe for JFW30; or, one 1' pipe for JFW38, and bag of ready-mix hearth material.)

- Unpack and remove parts carefully from carton. Porcelain finish is glass and should be treated as such. Any sharp blow or dropping porcelain parts on hard surface may chip the finish. The Matte Black painted finish is porous and will stain easily. Clean hands or protective paper should be used.
- Place the Fireplace in the desired location, aligning with the chimney projecting through the ceiling. Do not fasten unit to the floor until installation is complete. Make sure floor protective material is in place beneath unit.
- Position one smoke pipe, crimped end up, on fireplace. (On porcelain a fine film of light grease, oil, vaseline, etc., will allow the joints to slide together easily.)
- Place universal adapter on top section of second smoke pipe. Note! Large end of universal adapter fits over the outside of the smoke pipe.
- Slide universal adapter into chimney base.
- Position smoke pipe and universal adapter assembly on adjacent smoke pipe section.
- Check alignment of installation for appearance, double checking that all flue joints are seated properly.
- To complete installation, secure unit to floor using screws or lag screws.
- Mix hearth refractory according to instructions and trowel into place in the hearth. (Do not remove mineral fiber insulation block if present.) Allow to dry for at least 24 hours before building a fire. Your first fire should be quite small, and not allowed to get too hot to allow for the final curing of the hearth material.

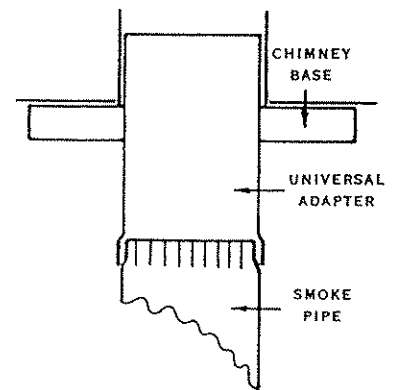

- Always replace screen after lighting fire.

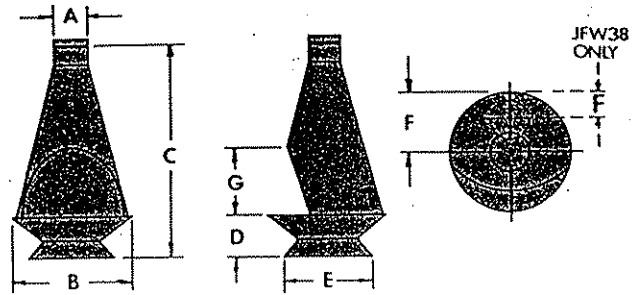

DIMENSIONS

MODEL	JFW24	JFW30	JFW38
A	7"	7"	10"
B	24"	30"	38"
C	43¼"	56"	77"
D	8"	8"	13¾"
E	18¼"	24"	24"
F	12"	15"	11¾"
G	15"	17"	21"
FLUSH CEILING RANGE	6'9" TO 7'8"	6'10½" TO 7'9½"	7'7½" TO 8'6½"
CEILING RANGE USING MAJESTIC BASE	7'1" TO 8'	7'2½" TO 8'1½"	7'11½" TO 8'10½"

(Package will accommodate ceilings in this range.)

Included with each unit package is one 1' and one 2' lengths of pipe for JFW24 — one 2' length pipe for JFW30, one 1' length of pipe for JFW38.



CLEARANCES

Before starting your installation, consult your applicable local code clearance requirements. The minimum clearances listed are most widely accepted nationally. The Jupiter Fireplaces are listed by:

- Inter. Conf. Bldg. Off. No. 1581
- So. Bldg. Code Cong. No. 7177-75
- Bldg. Off. Code Admin. No. 71-21

Protective floor covering area required for all combustible floors. Suggested material, ⅝" Asbestos Millboard or equivalent non-combustible material.

CLEARANCES

MODEL	TO COMBUSTIBLE WALLS			TO NON-COMBUSTIBLE WALLS*		
	JFW24	JFW30	JFW38	JFW24	JFW30	JFW38
V	18"	18"	18"	4"	4"	4"
W	30"	30"	30"	7"	7"	7"
X	18"	18"	18"	18"	18"	18"
Y	18"	18"	18"	18"	18"	18"
Z	30"	33"	32"	16"	19"	18"

*NOTE: Walls must be covered with ⅝" thick Asbestos Millboard or equivalent. Due to the wide variance of non-combustibles recognized by building officials, these clearances are recommendations only.

NOTE: 18" clearance required from outer edge of smoke pipe to combustible wall or ceiling.

Jupiter Fireplaces are to be attached to a chimney suitable for use with residential type and building heating appliance chimney with equal flue size.

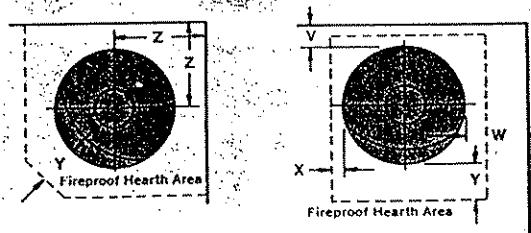

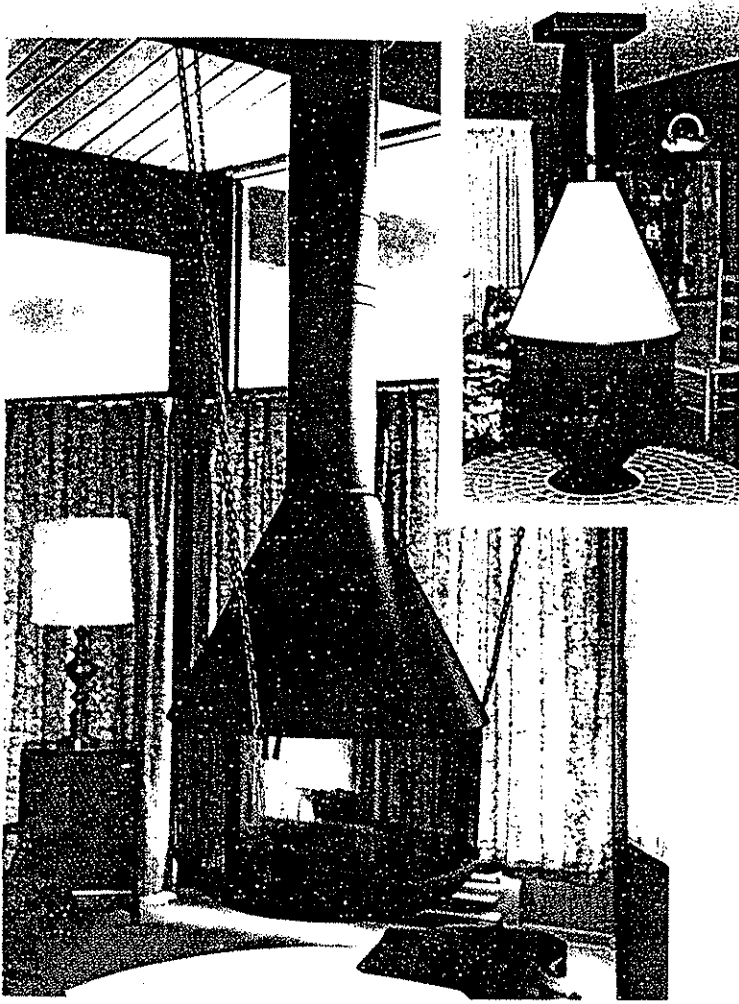

Majestic®

Mercury

enjoyable from any angle

Presenting the crackle of burning logs in all directions with traditional modern flair and masculine ruggedness, the MERCURY is adaptable to many interiors. Residential and commercial installations are individualized by selecting the optional components available with either the 36" or 42" models offered.

The basic unit consists of either colored porcelain finishes or matte black painted fireplace hood, universal adapter, circle screen, hearth pan, ready-mix refractory material, and matte black pipe for an 8' ceiling (using a Majestic Chimney Base). For a hanging installation, an optional chain set is available and must be specified. To make a free-standing installation, specify the available pedestal base. The basic unit, with or without chains, may also be used as a free-standing fireplace nested in custom masonry firebox. Black matte painted flue pipe complements the porcelain colored hood on the 36" unit; 42", matte black only. For the home, lodge, restaurant or hotel, the MERCURY offers a variety of dramatic installation possibilities. Log basket grate optional equipment.

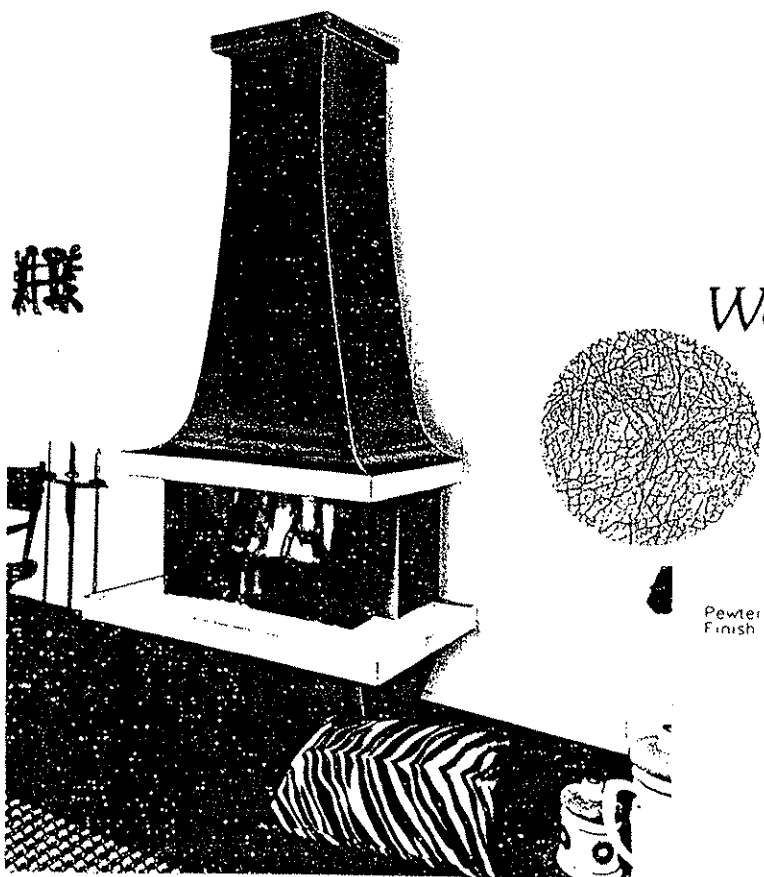

Tudor

Wood-burning—Wall-hanging

A new wood-burning fireplace that combines the time-proven Majestic Thulman principle and the decorative combination of a free-standing/wall-hanging fireplace. This full 32"-opening beauty requires no framing or finishing — no walls to tear out — simply set it on any wood floor, secure it against the wall, and install Majestic triple-wall chimney to the roof termination. The embossed steel pewter or matte black finished hoods, with stainless steel trim, extend to the ceiling and accentuate the real wood-burning fire chamber with factory-installed sliding fire screens and raised stainless steel hearth. The black Tudor may be painted with wall paint if desired. Adapts to ceiling heights of 6'10" to 8'0". Underwriters Laboratories, Inc. listed. Log basket grate optional equipment.

Mercury®

DIMENSIONS

MODEL	MFW36	MFW42
A	10"	12" **
B	36"	42"
C	64"	65"
D	18"	18"
E	24"	24"
F	12"	12"
G	14"	14"
FLUSH CEILING RANGE	7'6 1/2" TO 8'5 1/2"	7'7 1/2" TO 8'6 1/2"
CEILING RANGE USING MAJESTIC BASE	7'10 1/2" TO 8'9 1/2"	7'11 1/2" TO 8'10 1/2"

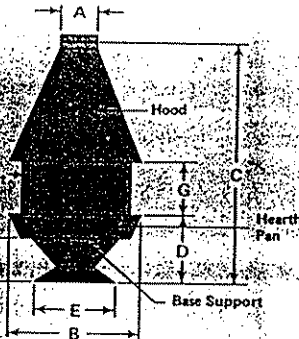

NOTE: Included with each unit package is one 2' length of black pipe.

(Package will accommodate ceilings in this range.)
 **MFW42 Fireplace uses a 12" chimney. This size chimney not available from Majestic.

CLEARANCES

Before starting your installation, consult your applicable code clearance requirements. The minimum clearances listed are most widely accepted nationally. The Mercury Fireplaces are listed by:

- Inter. Conf. Bldg. Off. No. 1581
- So. Bldg. Code Cong. No. 7177-75
- Bldg. Off. Code Admin. No. 71-21

Protective floor covering area required for all combustible floors. Suggested material, 3/8" Asbestos Millboard or non-combustible equivalent.

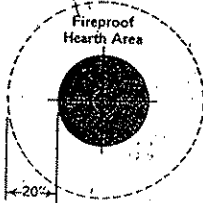

CLEARANCES

	TO COMBUSTIBLE WALLS	TO NON-COMBUSTIBLE WALLS*
MFW36	50"	24"
MFW42	52"	24"

*NOTE: Walls must be covered with 3/8" thick Asbestos Millboard or equivalent. Due to the wide variance of non-combustibles recognized by building officials, these clearances are recommendations only.
 NOTE: 18" clearance required from outer edge of smoke pipe to combustible wall or ceiling. Mercury Fireplaces are to be attached to a chimney suitable for use with residential type and building heating appliance chimney with equal flue size.

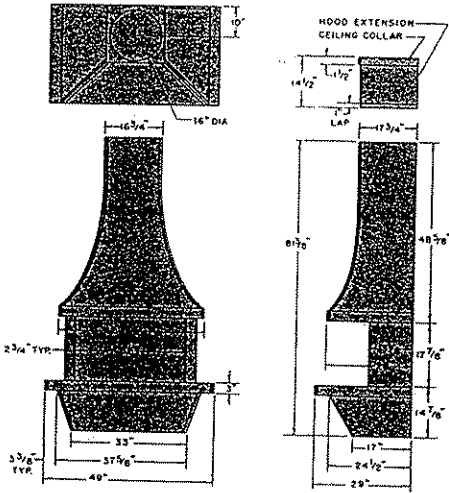

Tudor®

MODEL WHW32

This fireplace can be installed in any room with a ceiling 6'10" to 8'0" range.



CLEARANCES

The Tudor may be placed directly on a combustible floor and against a combustible back wall without clearance. Side wall clearance must be a minimum of 36" to combustible materials. Chimney sections require 1" clearance.

MAXIMUM HEIGHT

Over-all height of fireplace and its chimney to be not more than 90 feet, with four (4) 30° elbows maximum.

CONTENTS OF SHIPPING

- CARTONS**
- WHW32-B Main fireplace unit
 - (2) FS3 firestop spacers
 - Bolt bag
 - Installation instructions
 - Tudor Fireplaces are listed by: Inter. Conf. Bldg. Off. No. 1581; So. Bldg. Code Cong. No. 7177-75; Bldg. Off. Code Admin. No. 71-21; Underwriters Laboratories, Inc.
 - WHW32-HI (Matte black hood) or WHW32-HP (Pewter hood)
 - Hood extension
 - (2) Hood mounting bars
 - Ceiling collar
 - Starter base
 - 92 Chimney section
 - Installation instructions

Mercury®



INSTALLATION INSTRUCTION

by **Majestic®**
An American-Standard Company

DIMENSIONS

MODEL	MFW36	MFW42
A	10"	12"***
B	36"	42"
C	64"	65"
D	18"	18"
E	24"	24"
F	12"	12"
G	14"	14"
Flush Ceiling Range	7'6½" to 8'5½"	7'7½" to 8'6½"
Ceiling Range Using Majestic Base	7'10½" to 8'9½"	7'11½" to 8'10½"

(Package will accommodate ceilings in this range.)
**MFW42 Fireplace uses a 12" chimney. This size chimney not available from Majestic.

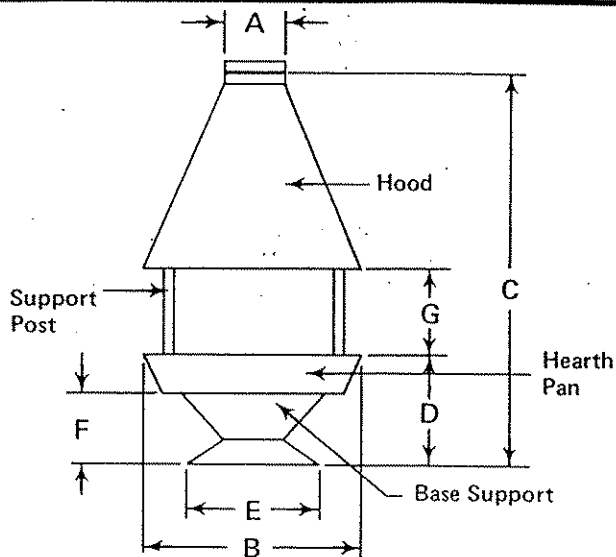

CLEARANCES

Before starting your installation, consult your applicable local code clearance requirements. The minimum clearances are widely accepted nationally. The Mercury Fireplaces are listed by the following building codes:

Inter Conf. Bldg. Off. No. 1581, So. Bldg. Code Cong. No. 7177-75, Bldg. Off. Code Admin. No. 71-21 Protective Floor Covering area required for all combustible floors. Suggested material, 3/8" Asbestos Millboard or equivalent non-combustible material.

Mercury Fireplaces are to be attached to a chimney suitable for use with residential type and building heating appliance chimney with equal flue size.

CLEARANCES

	TO COMBUSTIBLE WALLS	TO NON-COMBUSTIBLE WALLS*
MFW36	50"	24"
MFW42	52"	24"

NOTE: *18" clearance required from outer edge of Smoke Pipe to combustible wall or ceiling.

* Walls must be covered with 3/8" thick Asbestos Millboard or equivalent. Due to the wide variance of non-combustibles recognized by building officials, these clearances are recommendations only.

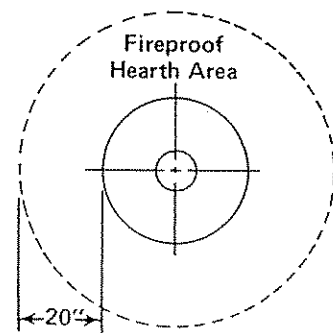

MERCURY FIREPLACE ASSEMBLY AND INSTALLATION INSTRUCTIONS USING MB BASE.

(Contents of shipping cartons: Hood with Screen installed, Hearth Pan with Mineral Fiber Insulation installed, three (3) Support Posts, Universal Adapter, one 2' section of pipe, package of six (6) Nuts, Bag of Ready Mix Hearth Material (shipped in separate carton), installation instructions. Base package consists of Base Support, three (3) Screws.)

To simplify installation we suggest two people assist.

- Unpack fireplace carefully to avoid scratches and damage to Hood, Base and Pipe. Porcelain finish is glass and should be treated as such. Any sharp blow or dropping porcelain parts on hard surface may chip the finish. The Matte Black painted finish is porous and will stain easily. Clean hands or protective gloves should be used.
- Turn fireplace on its side. (Remove Mineral Fiber Insulation.)
- Secure Base
- Support (MB) to Hearth Pan with three (3) screws.
- Return Fireplace and Base to upright position and replace Mineral Fiber Insulation.
- Determine desired location of fireplace. (Refer to Clearance Restriction.)
- Install Chimney and Chimney Base per accompanying instructions.
- Center fireplace assembly under Chimney Base.
- Slide Universal Adapter into Chimney Base and Hold. (See Diagram A).
- Position Smoke Pipe, crimped end up, on fireplace. (On porcelain, a fine film of light grease will allow the joints to slide together easily.)
- Lower Universal Adapter on to Smoke Pipe (Large end of Universal Adapter fits over the outside of the Smoke Pipe.)
- Check alignment and adjust if necessary.
- If desired secure base to floor using lag screws (optional — screws not furnished).
- Mix Hearth Refractory according to instructions and trowel into place in the hearth. (Pour over Mineral Fiber Insulation.) Allow to dry for at least 72 hours before building a fire or setting any object on hearth.
- Install Grate, Build first fire small to allow for gradual warm-up and curing of Hearth Refractory. Always close Screens after lighting fire.

DIAGRAM 'A'

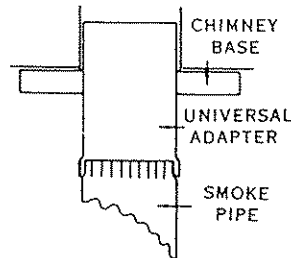

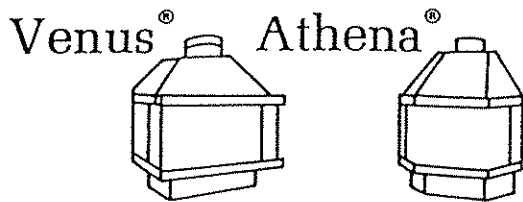

INSTALLATION INSTRUCTION

by **Majestic[®]**
An American-Standard Company

DIMENSIONS

MODEL	VFW36	AFW39
A	10"	9"
B	36"	37½"
C	45¾"	45¾"
D	25"	28"
E	10"	10"
F	20"	22"
G	28¼"	31"

Flush Ceiling Range 6'10¾" to 7'9¾"
Ceiling Range Using Majestic Base 7'2¾" to 8'1¾"
(Package will accommodate ceilings in this range.)

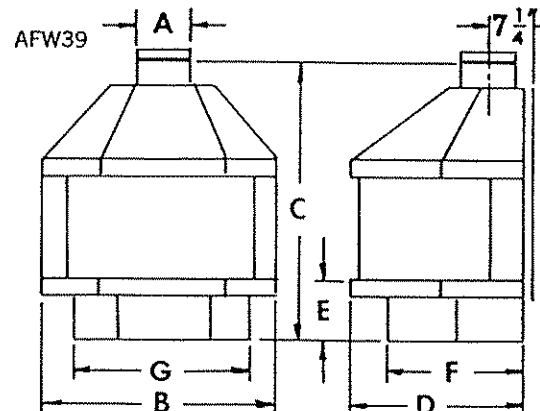
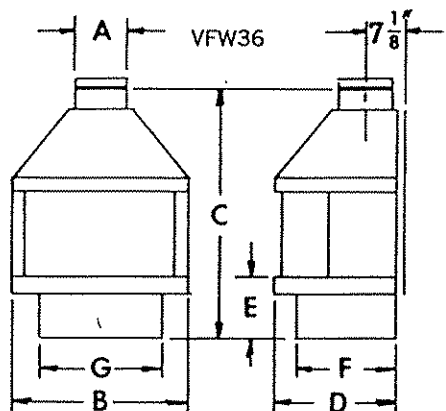

CLEARANCES

Before starting your installation, consult your applicable local code clearance requirements. The minimum clearances listed are most widely accepted nationally. The Venus and Athena Fireplaces are listed by:

Inter. Conf. Bldg. Off. No. 1581 So. Bldg. Code Cong. No. 7177-75 Bldg. Off. Code Admin. No. 71-21

Protective Floor Covering area required for all combustible floors. Suggested material, Slate, Stone, Ceramic Tile, Asbestos Board or equivalent non-combustible material at least ¾" thick.

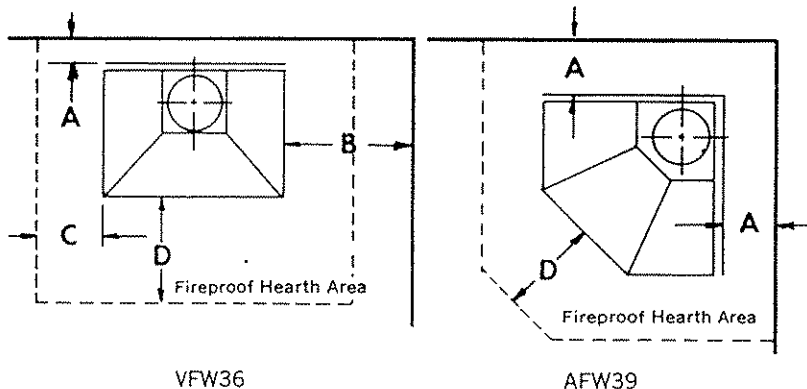

CLEARANCES

MODEL	TO COMBUSTIBLE WALLS COMBUSTIBLE WALLS		TO NON-COMBUSTIBLES MASONRY— STONE— BRICK—ETC.*	
	VFW36	AFW39	VFW36	AFW39
A	10"	10"	4"	4"
B	36"	—	24"	—
C	12"	—	12"	—
D	18"	18"	18"	18"

NOTE: 18" clearance required from outer edge of Smoke Pipe to combustible wall or ceiling.

ASSEMBLY INSTRUCTIONS

(Contents of shipping carton: pre-assembled fireplace, screen, universal adapter, one 1' and one 2' length of pipe, bag of ready-mix hearth material.)

- Unpack and remove parts carefully from carton. Porcelain finish is glass and should be treated as such. Any sharp blow or dropping porcelain parts on hard surface may chip the finish. The Matte Black painted finish is porous and will stain easily. Clean hands or protective paper should be used.
- Place the Fireplace in the desired location, aligning with the chimney projecting through the ceiling. Do not fasten unit to the floor until installation is complete. Make sure floor protective material is in place beneath unit.
- Apply a generous portion of furnace cement to the inner flange of the flue collar fastened to the top of the unit.

- Fit damper collar section down into flue collar and push down snugly. Make sure damper handle is aligned in the direction you desire it for appearance.
- Position one smoke pipe, crimped end up, on fireplace (on porcelain a fine film of light grease, oil, vaseline, etc., will allow the joints to slide together easily.)
- Place universal adapter on top section of second smoke pipe. Note! Large end of universal adapter fits over the outside of the smoke pipe.
- Slide universal adapter into chimney base.
- Position smoke pipe and universal adapter assembly on adjacent smoke pipe section.
- Check alignment of installation for appearance, double check that all flue joints are seated properly.
- To complete installation, secure unit to floor using screws or lag screws.

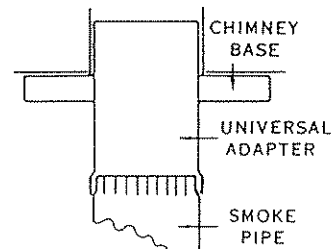

- Mix hearth refractory according to instructions and trowel into place in the hearth. (Do not remove mineral fiber insulation block if present.) Allow to dry for at least 24 hours before building a fire. Your first fire should be quite small, and not allowed to get too hot to allow for the final curing of the hearth material.
- Always close screen after lighting fire.



Majestic®

Venus

locates close to wall

For a conventional look with the right touch of contemporary styling — the Venus and Athena wood-burning fireplaces are the answer. The VENUS fireplace (top right) conserves valuable floor space, since the built-in construction features allow minimum back and side wall clearance. The matte black pipe and brass trim complement any of the porcelain colors shown on page 2, or the unit may be all matte black. A long, uninterrupted front panel can be personalized with accent trim of infinite variety. The large hearth size, fully screened, accepts large logs for maximum enjoyment. Included with the pre-assembled fireplace are screen, universal adapter, road mix refractory hearth material and matte black pipe for an 8" ceiling (using a Majestic Chimney Base). Log basket grate is optional equipment.

Athena
goes in a corner

ATHENA follows the same design style of Venus, with two added advantages. The 90° design of the fireplace allows it to be installed into any available corner space so frequently wasted. It also features the Majestic exclusive "SILENT BUTTER" ash drawer that collects ashes through an ash dump built into the firebrick hearth for cleaner, easier ash removal. Athena is available in any of the porcelain colors or matte black, complemented by the all matte black flue pipe. This wasted space is converted into a stunning focal point in any room decor. Included with this pre-assembled fireplace are screen, universal adapter, matte black pipe for an 8" ceiling (using a Majestic Chimney Base) and pipe shield. Log basket grate is optional equipment. Underwriters Laboratories, Inc. listed.

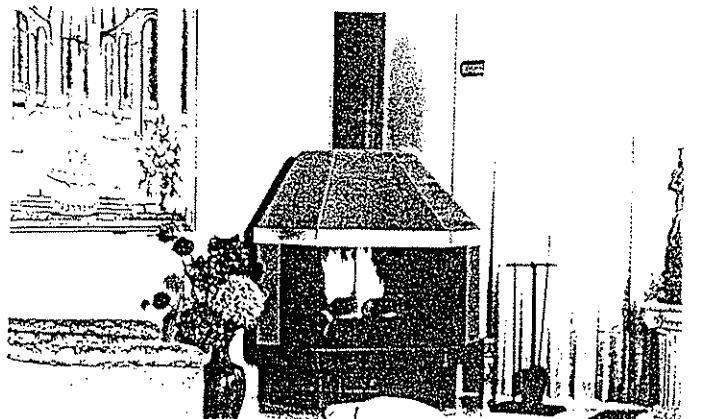
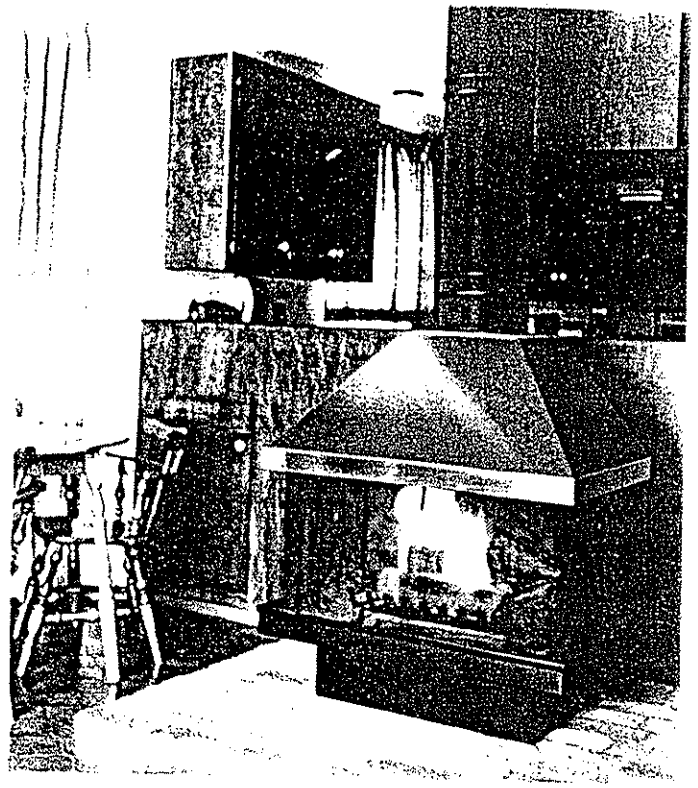

Venus®

DIMENSIONS

MODEL	VFW36
A	10"
B	36"
C	45 3/4"
D	25"
E	10"
F	20"
G	28 1/4"
H	7 1/8"

FLUSH CEILING RANGE 6'10 3/4" TO 7'9 3/4"
 CEILING RANGE USING MAJESTIC BASE 7'2 3/4" TO 8'1 3/4"

(Package will accommodate ceilings in this range.)

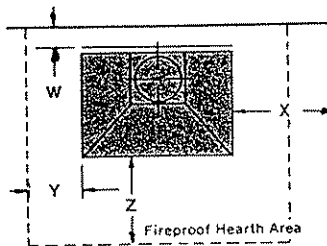
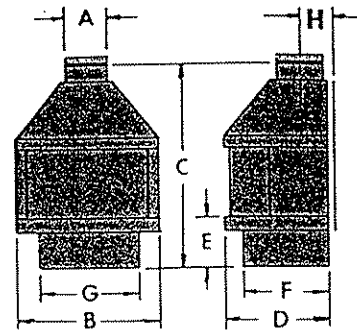

*NOTE: Walls must be covered with 3/8" thick Asbestos Millboard or equivalent. Due to the wide variance of non-combustibles recognized by building officials, these clearances are recommendations only.

Athena and Venus Fireplaces are to be attached to a chimney suitable for use with resident type and building heating appliance chimney with equal flue size.

Included with each unit package is one 1' and one 2' lengths of pipe for VFW36 and AFW39U, and one pipe shield.

CLEARANCES

MODEL	TO COMBUSTIBLE WALLS	TO NON-COMBUSTIBLE WALLS*
	VFW36	VFW36
W	10"	4"
X	36"	24"
Y	12"	12"
Z	18"	18"

Athena®

DIMENSIONS

MODEL	AFW39U
A	9"
B	37 1/2"
C	46 1/2"
D	28"
E	10"
F	22"
G	31"
H	7 1/4"

FLUSH CEILING RANGE 6'11 1/2" TO 7'10 1/2"

CEILING RANGE USING MAJESTIC TO BASE 7'2 1/2" TO 8'1 1/2"

(Package will accommodate ceilings in this range.)

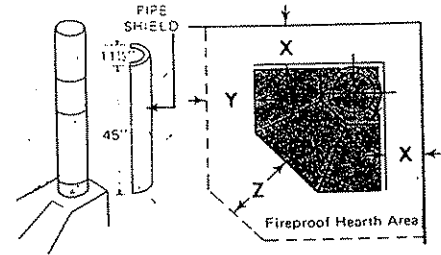
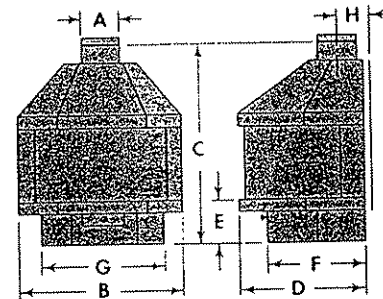

CLEARANCES

MODEL	TO COMBUSTIBLE WALLS	TO NON-COMBUSTIBLE WALLS*
	AFW39U	AFW39U
X	10"	4"
Y	12"	12"
Z	18"	18"

CLEARANCES

Before starting your installation, consult your applicable local code clearance requirements. The minimum clearances listed are most widely accepted nationally. The Venus and Athena Fireplaces are listed by:

- Inter. Conf. Bldg. Off. No. 1581
- So. Bldg. Code Cong. No. 7177-75
- Bldg. Off. Code Admin. No. 71-21

Protective floor covering area required for all combustible floors. Suggested material, 3/8" Asbestos Millboard or equivalent non-combustible material.