

heatilator®

The first name in fireplaces

Hearth & Home Technologies-Mt. Pleasant
1915 W. Saunders Street
Mt. Pleasant, Iowa 52641
Division, HON INDUSTRIES
www.heatilator.com



INSTALLATION & OPERATING INSTRUCTIONS

EC36 EC39 EC42
WOODBURNING FIREPLACE



WARNING!

Improper installation, adjustment, alteration, service or maintenance can cause injury or property damage. Refer to this manual. For assistance or additional information, consult a qualified installer, service agency or the gas supplier.

Table of Contents

Design and Installation Considerations 3
A. Listings and Code Approvals 4
B. Description of the Fireplace System 4
C. Fireplace System Components 5
D. Pre-Installation Preparation 10
E. Chimney Requirements 12
F. Installation of Fireplace 15
G. Constructing a Chase 22
H. Operating Instructions 25
I. Maintenance Instructions 29
Index 31
Warranty 32

CAUTION:

Do not expose the fireplace to the elements (i.e. rain, etc.) and keep the fireplace dry at all times. Wet insulation will produce an odor when the fireplace is used.

Safety Precautions

1. Please read these installation instructions completely before beginning installation procedures. Failure to follow them could cause a fireplace malfunction resulting in serious injury and/or property damage.
2. Always check your local building codes prior to installation. The installation must comply with all local, regional, state and national codes and regulations.
3. An adequate supply of replacement combustion air from outside the house must be available to the fire for the fireplace to operate properly. To achieve this, the use of the optional outside air kit is highly recommended.
In the event the home is unusually tightly sealed, the optional combustion air kit may not provide all the air required to support combustion. Hearth & Home Technologies Inc. is not responsible for any smoking or related problems that may result from the lack of adequate combustion air. It is the responsibility of the builder/contractor to ensure that adequate combustion air has been provided for the fireplace.
4. The fireplace must be installed with the Hearth & Home Technologies Inc. SL Series Chimney System.
The chimney system must always terminate outside the building. Be sure to follow all chimney specifications given in these installation instructions.
5. **NEVER** leave children unattended when there is a fire burning in the fireplace.
6. This fireplace is built for solid fuel only. **NEVER** use gasoline, gasoline type lantern fuel, kerosene, charcoal light fluid, or similar liquids in this fireplace. Keep any flammable liquids a safe distance from the fireplace.
7. **DO NOT** use chimney cleaners or flame colorants in your fireplace.
8. The flue damper must be open at all times when the fireplace is in use.
9. While servicing this fireplace, always shut off any electricity or gas to the fireplace. This will prevent possible electric shock or burns. Also, make sure the fireplace is completely cooled before servicing.
10. To ensure a safe fireplace system and to prevent the build up of soot and creosote, inspect and clean the fireplace and chimney prior to use and periodically during the burning season. See "Maintenance Instructions" in this manual for cleaning instructions.

DESIGN AND INSTALLATION CONSIDERATIONS

When selecting a location for your woodburning fireplace, it is important to evaluate a number of considerations. Modern construction techniques can create conditions that may not allow your chimney to draft properly. This may result in smoke spillage from your fireplace, as well as cause other combustion appliances to operate incorrectly.

Tightly sealed construction is important for energy efficiency. Unfortunately, a great deal of effort has been directed to tightening up sidewall construction, while considerably less attention has been paid to tightening upper portions of the warm air envelope (insulated ceilings). This has increased the "Stack Effect", a condition that increases the negative pressure generated by the structure. This negative pressure will directly affect the drafting performance of a fireplace chimney. To minimize the negative pressure generated by stack effect, make certain that all ductwork installed in the attic spaces is sealed airtight. Minimize the number of recessed light fixtures installed in the insulated ceiling, and use sealed recessed light fixtures. Finally, make certain the whole house fans and attic access panels are tightly sealed. These are important design considerations that must be observed during the design and construction stage of the home.

If you desire to put a fireplace in your basement, we recommend that you consider a direct vent gas fireplace. Basements always have a significant negative air pressure that causes the fireplace system to be more susceptible to smoke spillage and cold flue back drafting. Since direct vent gas fireplaces are sealed, they are not affected by the negative pressure that exists in basements.

Finally, woodburning fireplaces perform best when their chimney (roof termination) is located on the upper half of the roof, especially when cathedral ceilings are present. Chimneys that are located on the lower half of the roof realize what is known as "lazy flue" and will not draft as well as a chimney that is located in the upper portion of the roof. The reason for this is that the stack effect generated by the overall height of the living spaces inside the house will exceed the draft generated by the chimney system. If you desire to place a woodburning fireplace in a location where the termination cap would be located on the lower half of a roof, such as on an outside wall at the base of a cathedral ceiling, we recommend that you consider using a direct vent gas fireplace. This will assure the homeowner a fireplace that operates correctly.

These properties do not affect just your woodburning factory built fireplace. They can cause any woodburning fireplace as well as any conventionally vented (B-vent) gas appliance to operate improperly. Careful planning at this stage of your project will ensure satisfaction with the operation of your fireplace once it is completed.

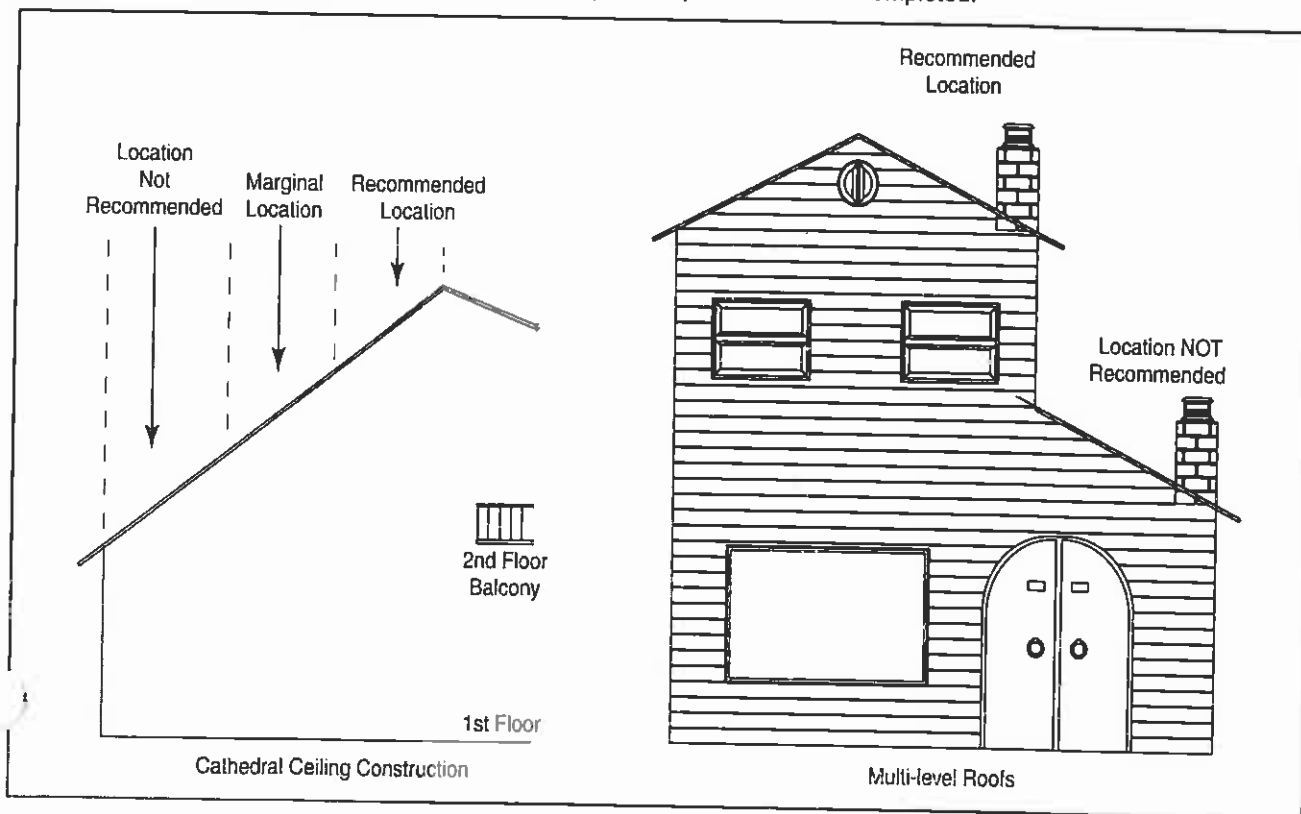

A. LISTINGS AND CODE APPROVALS

This fireplace system has been tested and listed in accordance with UL 127 standards, and has been listed by Underwriters Laboratories Inc. for installation and operation in the United States and Canada as described in this manual.

This fireplace has been tested and listed for use with the optional components listed on page 5. These optional components may be purchased separately and installed at a later date. However, installation of an outside air kit will require significant reconstruction, and should be installed at the time of the initial fireplace installation.

Check with your local building code agency prior to installing this fireplace to ensure compliance with local codes, including the need for permits and follow-up inspections. If you need assistance during installation, please contact your local dealer or the Heatilator Technical Services Department, Hearth & Home Technologies, 1915 W. Saunders St., Mt. Pleasant, Iowa 52641 (1-800-843-2848).

Heatilator® is a registered trademark of Hearth & Home Technologies Inc., Division of HON INDUSTRIES.

WARNING!

This fireplace and its components are designed to be installed and operated as a system. Any alteration to or substitution for items in this system, unless allowed by these installation instructions, will void the Underwriters Laboratories listing and may void the product warranty. It may also create a hazardous installation. Read through these instructions thoroughly before starting your installation and follow them carefully throughout your project.

B. DESCRIPTION OF THE FIREPLACE SYSTEM

1. The Heatilator fireplace system consists of the following:
 - a. Fireplace/Integral Grate
 - b. Refractory
 - c. Chimney Termination Cap
 - d. Chimney System
 - e. Hearth Extension
2. Optional Components Include:
 - a. Glass Doors
 - b. Chimney Air Kit
 - c. Outside Combustion Air System
 - d. Fan Kit

Note: Illustrations used throughout these instructions reflect "typical installations" and are for design purposes only. Actual installation may vary slightly due to individual design preferences. However, minimum and maximum clearances must be maintained at all times.

The illustrations and diagrams used throughout these installation instructions are not drawn to scale.

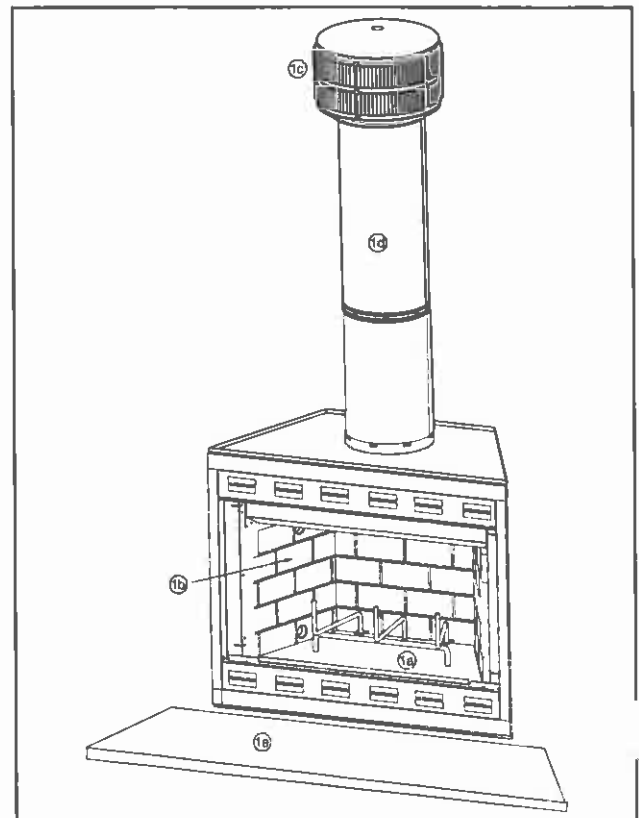

Figure 1 - Typical Fireplace System

C. SYSTEM COMPONENTS

1. Fireplace Components

Catalog #			Description:
EC36	EC39	EC42	Fireplace, includes integral grate and hearth protection strips.
HX3	HX3	HX4	Hearth Extension
DM1036	DM1039	DM1042	Original Bifold Glass Doors - Black Finish
DM1036B	DM1039B	DM1042B	Original Bifold Glass Doors - Polished Brass Finish
DM1036S	DM1039S	DM1042S	Original Bifold Glass Doors - Stainless Steel Finish
DMA1036B	none	DMA1042B	Arched Cabinet Style Glass Doors - Polished Brass Finish
DP1036	none	DP1042	Perception Glass Doors - Black Finish
DP1036B	none	DP1042B	Perception Glass Doors - Polished Brass Finish
DP1036S	none	DP1042S	Perception Glass Doors - Stainless Steel Finish
GR4	GR5	GR6	Integral Grate (included with fireplace)
BC10			Fan Speed Control
FK18			Fan Kit with JK8 Junction Box
JK8*			Junction Box Kit
AK14			Outside Air Kit

*The JK8 junction box must be installed at the time of initial fireplace installation or considerable reconstruction may be required.

HEARTH EXTENSION

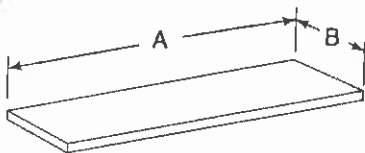

Cat. #	A	B
HX3	52"	16"
HX4	66"	20"

GLASS DOORS

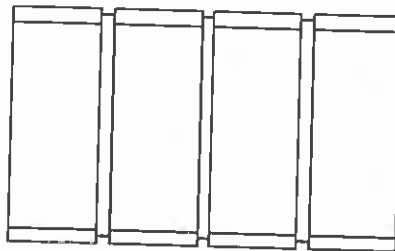

DM1036/DM1036B/DM1036S
DM1039/DM1039B/DM1039S
DM1042/DM1042B/DM1042S

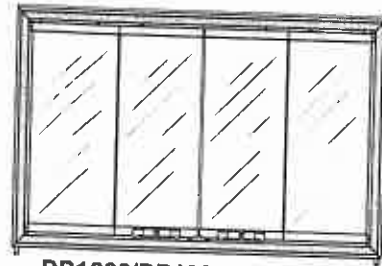

DP1036/DP1036B/DP1036S
DP1042/DP1042B/DP1042S

JUNCTION BOX

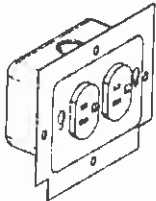

JK8

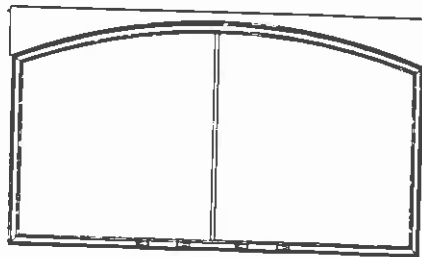

DMA1036B
DMA1042B

INTEGRAL GRATE (supplied)



GR4, GR5, GR6

FAN KIT

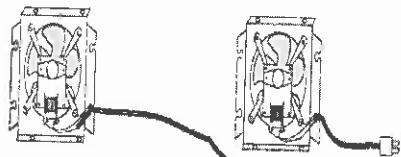

FK18

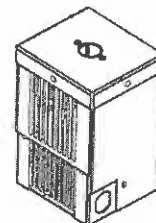

BC10
Fan Speed Control

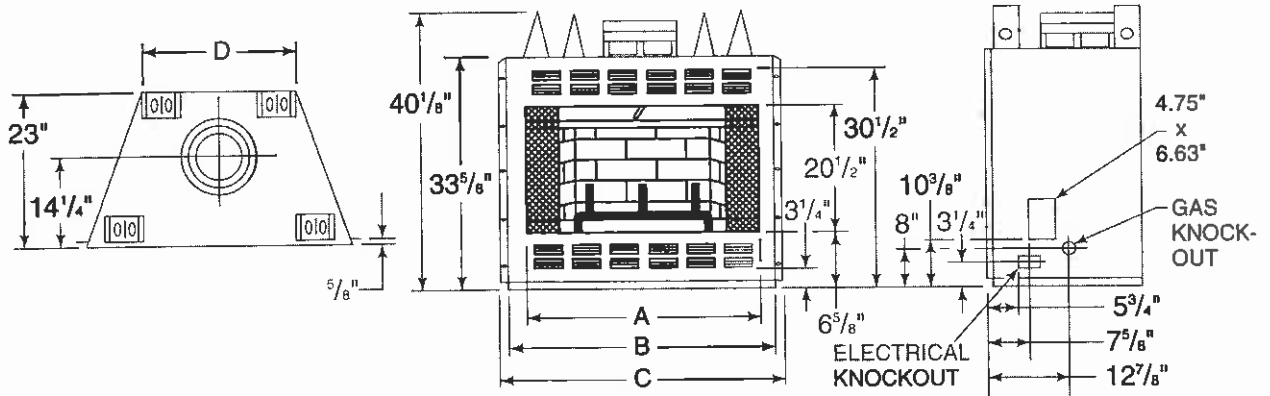

Cat. #	A	B	C	D
EC36	36"	41"	43"	25 1/4"
EC39	39"	44"	46"	28 1/4"
EC42	42"	47"	49"	31 1/4"

Fireplace Dimensions

OUTSIDE AIR KIT

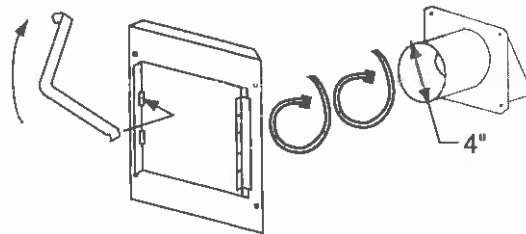

AK14

2. Chimney Components

The following pictures show only those chimney components which may be safely used with this fireplace.

Catalog #	Description:
CAK4A	Chimney Air Kit
ID4	Insulated Duct/Outside Air
UD4	Uninsulated Duct/Outside Air
SL306	Chimney Section - 6" long
SL312	Chimney Section - 12" long
SL318	Chimney Section - 18" long
SL324	Chimney Section - 24" long
SL336	Chimney Section - 36" long
SL348	Chimney Section - 48" long
SL3	Chimney Stabilizer
SL315	Chimney Offset/Return - 15°
SL330	Chimney Offset/Return - 30°
FS338	Firestop - Straight
FS339	Firestop - 15°
FS340	Firestop - 30°
AS8	Straight Attic Insulation Shield, 24"
JB877	Chimney Joint Band
CB876	Chimney Bracket
RF370	Roof Flashing - Flat to 6/12 Pitch
RF371	Roof Flashing - 6/12 to 12/12 Pitch
TR344	Round Termination Cap
TR342	Round Telescoping Termination Cap
ST375	Square Termination Cap
TS345	Square Termination Cap
TS345P	Square Termination Cap - Painted
CT35	Chase Top
LDS33	Decorative Shroud - 3' x 3'
LDS46	Decorative Shroud - 4' x 6'

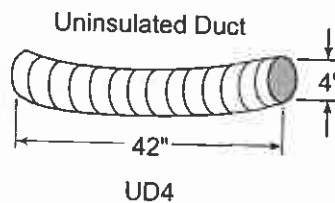
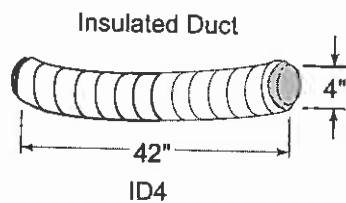

The first name in fireplaces

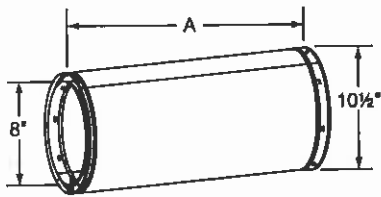

Chimney Sections

Catalog #	A	B
SL306	6"	4 3/4"
SL312	12"	10 3/4"
SL318	18"	16 3/4"
SL324	24"	22 3/4"
SL336	36"	34 3/4"
SL348	48"	46 3/4"

A = Actual length
B = Effective length (length of chimney part after it has been snapped to another)

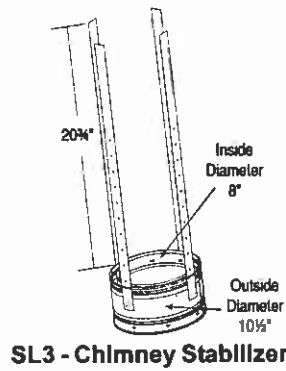

SL3 - Chimney Stabilizer

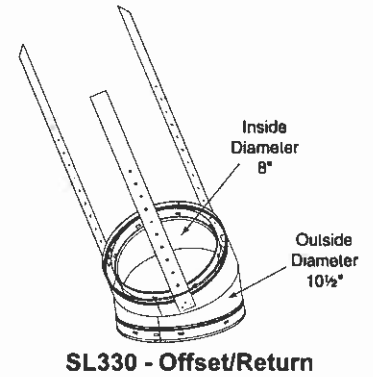

SL330 - Offset/Return

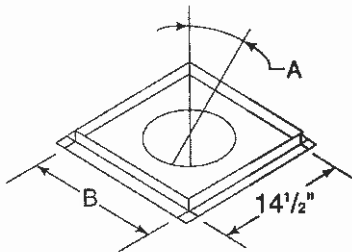

Firestop Spacer

Catalog #	A	B
FS338	0°	14 1/2"
FS339	15°	18 3/8"
FS340	30°	23"

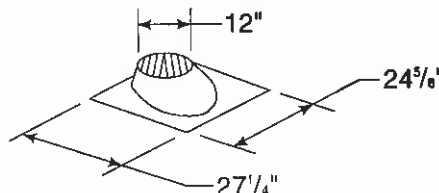

**RF370 - Roof Flashing
Flat to 6/12 Pitch**

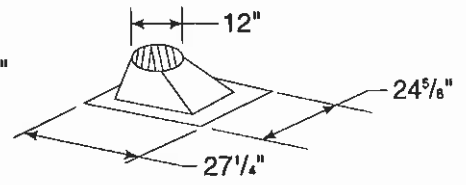

**RF371 - Roof Flashing
6/12 to 12/12 Pitch**

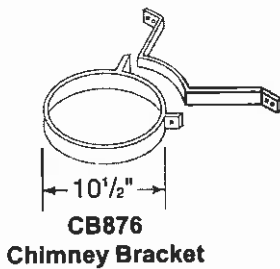

**CB876
Chimney Bracket**

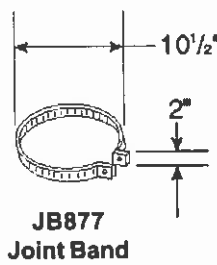

**JB877
Joint Band**

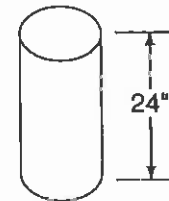

**AS8
Straight Attic
Insulation Shield**