

The Century
Fireplace Furnace



. . .the wood or gas-burning
Furnace that looks like a Fireplace.

MODEL CO-36-WG
INSTALLATION INSTRUCTIONS
&
OWNER'S MANUAL

The Century
Fireplace Furnace



**CENTURY
FIREPLACE-FURNACE INSTALLATION INSTRUCTIONS
GAS**

Model C0-36-WG
Gas/Optional Fuel Wood

GENERAL INFORMATION

INTRODUCTION

The CENTURY CO-36-WG is designed to be equipped with an optional up to 85,000 BTU gas log system Certified by the AGA. This unit is equipped for natural gas but may be converted to LP. The maximum output with wood is 160,000 BTU. The CO-36-WG must be installed with 10" Metal Fab flue Class A 2,100 degree system. Twelve feet of pipe and accessories for the average single story home comes with the CENTURY package. The CENTURY C0-36 IS TESTED TO UL-127 AND UL 391. The CENTURY is designed to be used as a free convection unit or may be centrally ducted throughout the home.

Gas equipped CENTURIES are thermostatically controlled and designed to provide the complete heating requirements of the average home. Additional supplemental heat may be added for larger homes or for periods of extreme cold. See your CENTURY dealer for additional information

The CENTURY is designed to be installed by your general contractor or a skilled homeowner. The hook-up of the electrical, gas, and duct work, however, must be installed by a licensed contractor and must be according to local codes.

Instructions cover selection of a proper location for your CENTURY unit, setting of the unit, flue pipe and accessories, framing dimensions and details, convection heat outlets, changing fuel from wood to gas, and installation of the various heat delivery systems applicable with the CENTURY. If the CENTURY is to be installed in a ducted system, the duct system must be engineered and installed per our specifications, by a competent, licensed heating company.

LOCAL CODES

When installing the CENTURY factory built fireplace-furnace system, local building codes should be consulted. Fireplace-furnace installation must be in compliance with local codes.

CLEARANCE TO COMBUSTIBLES

- A. Floor - The Century unit may be place directly on a combustible floor that is protected by a concrete board such as Duroc or the equivalent.

- B. Walls (Enclosure) - Steel stud framing covered with sheetrock may be placed directly against The side, back, and front spacers attached to the unit. These spacers maintain a 2" clearance from The shell and 3" in the back.

- C. Walls (Room) - Intersecting side walls should be a minimum of 24" from glass door opening. (*Illustrations A & B, pg. 10*)

NOTE: DRAWINGS AND ILLUSTRATIONS NOT TO SCALE

Tested to UL-127 and UL-391

In House Quality Control Services by
PFS CORPORATION, MADISON, WI

Revised 11/07

D. Convection Heat Outlets and the Glass Door Assembly - Convection heat outlets and the glass door assembly requires a ¾" clearance by which is maintained the attached spacers around the door and convection heat outlets. These framing spacers have a ½" lip turned up around the front side of the framing spacer. The lip on the convection heat outlets should be aligned with the factory-installed lip on the framing spacer around the door. The lip on the framing spacers around the door and convection heat outlets must be the outermost point of your finished wall. The trim on the convection outlets extends outward from your finished wall ¾", allowing house air to enter through these openings to cool the unit and return to the house through the 4" X 8" chase heat return grill, which must be installed 2" below the Ceiling of the chase per *Illustrations G, H, and W*. CAUTION: All clearances and air spacers must be maintained - no exceptions.

E. Chimney - The Metal Fab Chimney which comes with your fireplace-furnace unit requires a minimum of 2" clearance. There is no other chimney approved for use with this unit. If additional chimney is required, it must be 21,000 Class A Vent Pipe, manufactured by Metal Fab, Wichita, Kansas, and is available from your CENTURY dealer.

F. Optional Ash Door Extension Kit - Framing may be placed within 1" of combustible material. The resulting gap should be filled with either mineral wool or fiberglass insulation without paper backing.

CENTURY INVENTORY LIST

A. FURNACE PARTS

1. Insulation Pad (install between ash box and floor (optional at additional charge)
2. Convection heat outlet assemblies (2)
3. Convection extensions *Optional at additional cost*
4. Log retainer / combustion air tubes
5. Ash Dump Door attached to extension for rear ash cleanout *Optional at additional cost*
6. Center hearth extension
7. Side hearth extensions *Optional at additional cost*
8. Convection trim
9. Chase heat return grill

B. CHIMNEY PARTS

1. 4- 10TG36 Pipe
2. 1 - 10TGFS Fire stop
3. 1 - 10TGC Cap
4. 1 - 10TGSC - Storm Collar
5. 1 - 10TGF Flashing (2 ½ - 5/12)
6. 10TGF - 15 Flashing (6/12 - 15/12) *Optional at additional cost*
7. 10TGF - 24 Flashing (16/12 - 24/1) *Optional at additional cost*
8. 10TGIS Insulation Shield *Optional at additional cost*

NOTE: Carefully inventory and check all parts of your fireplace system. Assure that no freight damage or Loss has occurred. If damage has occurred, file claim with carrier immediately. Read each step of these installation instructions before starting to assemble including the Metal Fab installation manual. The installer of each phase of the installation must sign off that he has read the instructions and installed the unit per the instructions. As signed copy of the compliance statement must be returned with your warranty card or your warranty will not be valid.

INSTALLATION INSTRUCTIONS

CAUTION: CONVECTION HEAT OUTLETS MUST BE INSTALLED ON UNIT IMMEDIATELY AFTER UNPACKING. UNIT MUST BE COVERED BEFORE AND DURING FRAMING TO PREVENT SAWDUST AND OTHER COMBUSTIBLE MATERIALS FROM COLLECTING ON AND INSIDE THE UNIT.

STEP 1 - SELECTION OF A LOCATION

Select a wall with a minimum width of 6', if a sidewall is involved, to accommodate your CENTURY unit. Pay close attention to the minimum side clearance specified in *Illustrations A & B*, page 10. If the CENTURY unit is to be installed with a central duct system, a location which will allow easy hook-up to the duct system is desirable but not imperative. Remove carpet or other combustible material from sub floor and install insulation pad or Duroc or equivalent on the floor before unit is set. *Illustrations R through U* show the various methods in which a central duct system may be installed.

STEP 2 - FLOOR FRAMING

The CENTURY is approved to be placed directly on a wood sub floor of $\frac{3}{4}$ " TG plywood or better, protected by a concrete board such as Duroc or the equivalent, and supported by 2" X 10" floor joists on 16" centers. This floor system is adequate to carry the CENTURY, steel stud wall covered with Duroc or equivalent or sheetrock, and a final wall finish of lightweight stone or $\frac{1}{2}$ " face brick. In the event you desire to use natural stone or a full brick wall, additional support will be needed. Consult your architect. When installing a duct system which requires below the floor ducting, you may be required to header off a floor joist to allow 1 $\frac{1}{2}$ " air circulation for the ducts. Install hardware cloth to cover the gap between the duct and the wooden floor to protect rodents out.

If you are planning new construction, a simple alternative is to start your first floor joist center of your CENTURY. Place joists 16" on center each way out from the CENTURY. This will eliminate the need to header off any joists. This method is for joists running 90 degrees to the face of the CENTURY. It is recommended the joists on each side of the center joist be doubled, with the additional joist being placed outside the original joist. This will provide support for the leg supports of the CENTURY. *Illustration P*

ILLUSTRATION P - New construction - First floor joist center of CENTURY.

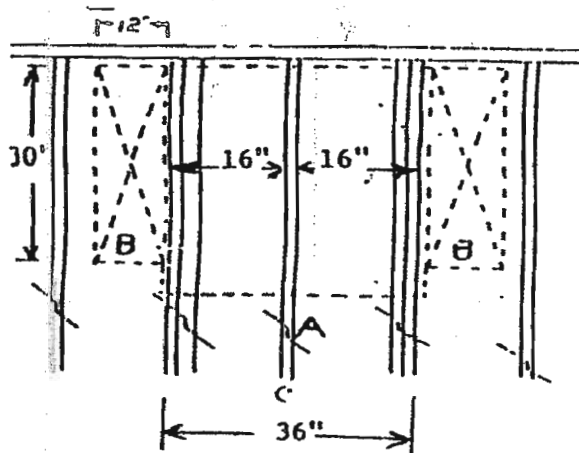

1. Place first joist center of CENTURY.
2. Dotted line shows outline of CENTURY. Position B shows outline of hole cuts for below the floor duct system. A minimum of 1 $\frac{1}{2}$ " air clearance must be maintained for ducts when dropped below floor, to 3' out from the CENTURY. Beyond 3' from the CENTURY, ducts do not require any air gap. The air gap may be filled with mineral wool or fiberglass insulation without paper backing. $\frac{1}{8}$ " hardware cloth should be attached to the wood floor closing the airspace for rodent protection.

system only.)

ILLUSTRATION Q - Typical header of joist, joists parallel to front of CENTURY. (below the floor duct system only.)

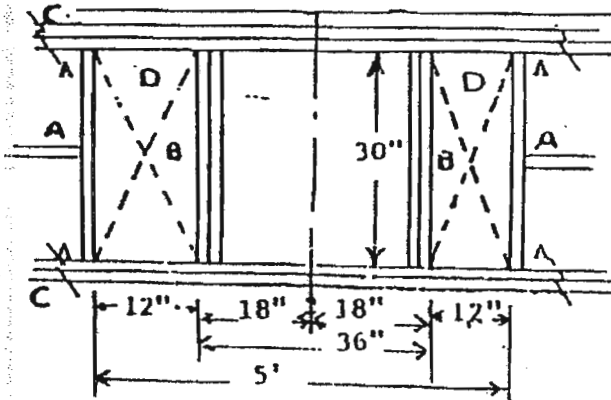

1. Header off joist leaving 5' in the clear. Position A use joist hangers.
2. Place doubled 2" X 10" support joists B on both sides.
3. Double joists both sides of joist headered off position C.
4. Area B both sides available for access for below the floor ducts. Minimum B opening 12" X 30".

STEP 3 - FIREPLACE-FURNACE CHASE FRAMING

A. The width of the chase area varies with each type of heating duct system you use. Check drawings for minimum width for each application. Fireplace chase must be sheet rocked with ½" Type X fire-rated sheetrock except for front wall. A ceiling must be installed in fireplace chase at or below the ceiling level of the room but no less than 7'6" or a minimum of 12" above the convection outlets. This ceiling must also be sheet rocked with Type X fire-rated sheetrock.

B. The fire stop (10TGFS) is to be installed in this ceiling. A fire stop must be installed at every ceiling or floor that the chimney goes through. (See Metal Fab Installation Manual). Chase heat grill must be installed 2" below the ceiling of chase to allow heat Produced from the metal outer shell of the CENTURY to return to the room.

C. Air is drawn in around the framing spacer surrounding the door and convection heat outlets, cooling the CENTURY; and is returned to the room through this chase heat return grill. This air circulation around the unit is imperative to the safe operation of the unit. If the chase is on an outside wall, the chase should be insulated.

D. If your design incorporated soldiering stone or brick over the convection grills, your entire front wall must be made of non combustible material.

CAUTION: BEFORE CHASE IS SEALED UP, COMBUSTIBLES SUCH AS SAWDUST, WOOD CHIPS, ETC., MUST BE REMOVED AND AREA AROUND UNIT VACUUMED AND THEN DUSTED WITH A DAMP CLOTH.

STEP 4 - CEILING IN THE CHASE AREA - A ceiling must be installed in the chase area for the following Reasons:

A. Air is drawn in to cool the CENTURY around the framing spacers on the door and the convection heat outlets. This house air circulates around the CENTURY and re-enters the living area through the chase heat grill located 2" below the ceiling of the chase. Without a ceiling in the chase, this house air would escape to the attic or to the outside around the flashing.

B. A fire stop must be installed at each floor or ceiling that the Metal Fab flue systems goes through. The fire stop is to be installed with the indented side facing down before sheet rocking. The indented section keeps the sheetrock away from the pipe.

Center of the chimney system is located in the center of the CENTURY. *Illustrations G, H, & I.* The ceiling in the chase must not be less than 7'6" above the floor or a minimum of 12" above the convection outlets, whichever is greater. CENTURY is not approved for homes that do not have a minimum of 7'6" ceilings.

STEP 5 - CHIMNEY SYSTEMS

CENTURY fireplace-furnace systems are designed and coded for use only with 10" Metal Fab (inner pipe diameter) chimney sections, offset and return elbows, fittings, and roof termination devices. CENTURY fireplace-furnace systems are tested for 40' maximum and 17' minimum height. This measurement includes fireplace, flue pipe, and the termination cap. A 15 degree or 30 degree offset elbow may be the first piece of flue pipe off the top of the fireplace-furnace. A fire stop must be used at every floor or ceiling your chimney passes through. Where the chimney goes through the roof, the flue must have a minimum of 2" clearance. No flashing or fire stop is used at the roof. See offset table *Illustration F* for various offsets. Enough flue pipe and accessories for minimum height is included with your CENTURY. Additional pipe, fire stops, and elbows may be purchased from your CENTURY dealer.

Roof framing and chimney heights - Various types of roofs require different framing dimensions. See *Illustration L.* See *Illustration M* for location and pictorial drawing of a typical complete chimney system.

CHIMNEY HEIGHTS ABOVE ROOF

See separate installation instructions packaged with each chimney part. Note: Extension of Chimney above roof, as required by UBC and NFPA 211, shall be at least 3' above the highest point where it passes through the roof of the building and also shall be at least 2' higher than any part of the building (including roof) within 10'. The amount of "effective flue length" of the termination device is used in calculating the 3' and 2' in 10' measurements above.

Illustration N

CHIMNEY ROUTE

A simple technique for aligning chimney passages is to plumb from ceiling level directly above hole which has just been completed. On straight flue pipe run from top of fireplace, plumb to center of flue collar from ceiling directly above, drive nail through ceiling from below to mark position, and then mark and cut passage from above ceiling (around nail). Thus you can always work "from the top down".

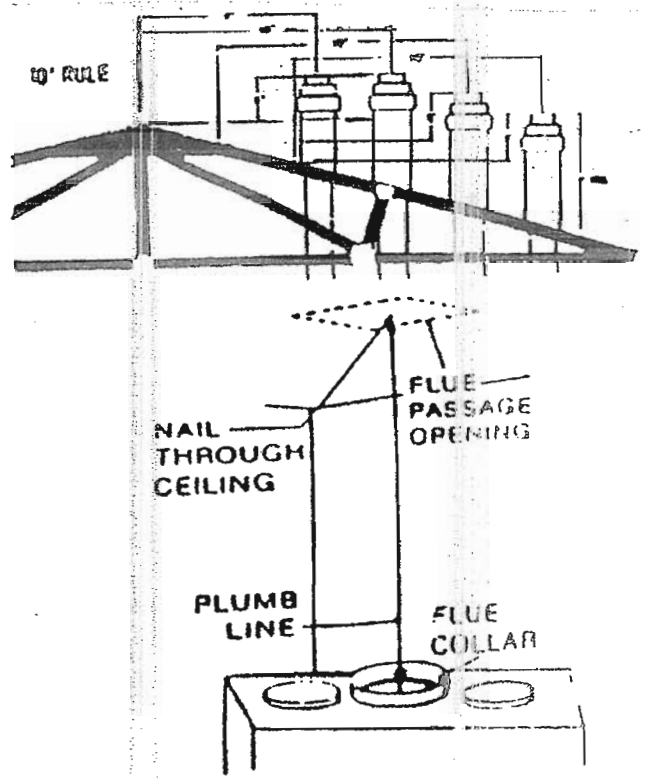

ROOF FLASHING

You must maintain a minimum of a 2" air gap around the flue - below, at, and above the roof line. It is recommended that a chimney be built around the flue above the roof, and that the flashing be installed on this chimney. The chimney structure provides support for your ladder when removing the cap to clean your flue.

Center roof flashing carefully over roof passage hole. Nail temporarily into position, so flashing will not slide off center. Make sure proper alignment exists with flue pipe below, and that flue pipe will fit in fully vertical position as it passes through flashing. Check vertical alignment of flue pipe. Secure flashing in place permanently by nailing along perimeter onto roof construction. If shingled roof, cover the side and upper flashing with roofing material, but cover the roofing with the lower part of the flashing. Cover nail heads with mastic. When using a wood chimney around the flue pipe, the flashing will be placed at the top of the wood chimney. A minimum of 2" air clearance must be maintained around the pipe. *Illustration J.*

STORM COLLAR

The flashing assembly includes a storm collar. Slide storm collar over outer flue pipe section, insert storm tab in slot, pull tight, and bend tab back over slot.

Seal storm collar to outer flue pipe with mastic bead around entire circumference of pipe. Also add extra mastic where storm collar meets flashing and to the tab/slot area to seal completely against water penetration. **NOTE;** Align storm collar with top surface of flashing.

FRAMING DIMENSIONS FOR CHIMNEY ROUTE
Minimum allowable (includes clearance)

TYPE FLUE	CEILING OPENING		ROOF OPENINGS	
	"A"	"B"	PITCH "C"	"D"
10" Metal Fab	17 1/4"	17 1/4"	0/12 14 7/16	17 1/2"
			6/12 14 7/16	17 1/2"
			12/12 14 7/16	17 1/2"
			60 Degree 14 7/16	34

ILLUSTRATION L

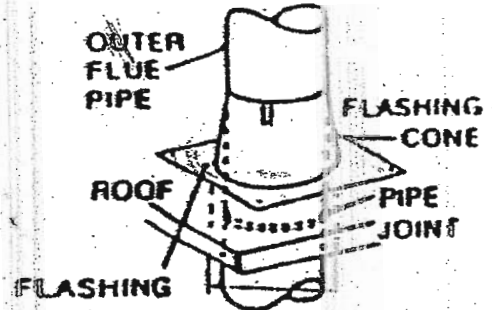
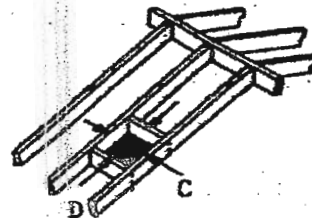
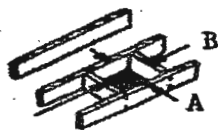

Standard roof flashing 0/12-2/12 pitch.
Optional flashings, 10TGF 2/12-5/12,
10TGF-15 6/12-15/12, 10TGF-24 6/12-24/12

ILLUSTRATION K

STEP 6 - OPTIONAL REAR ASH BOX CLEANOUT KIT #1214

A. Kit consists of a 7" to 12" expandable galvanized extension with an attached cast iron Cleanout door, insulation, and foil-backed duct tape.

B. The optional rear adjustable cleanout assembly is to be attached to the rear of the ash box. First, remove the rear cover plate and attach ash box extension reusing the 4 bolts and Attached gasket. Extend the cleanout assembly to desired position (maximum of 12"). Duct Tape the galvanizing extension at slip joint to prevent air leakage and insulate around extension with the 1" X 12" X 40) insulation (insulation and tape furnished with kit.)

STEP 7 - COMBUSTION AIR

The CENTURY unit is equipped with a 4" outside combustion air duct located at the rear of the unit, which must be connected to an outside air source. *Illustrations A & D* show dimensions for wall cuts. If the combustion air must run more than eight feet, increase size beneath floor to 6" galvanized pipe.

CAUTION: Combustion air must not be drawn from a garage or attic area where flammable materials may be stored.

STEP 8 - CONVECTION HEAT OUTLET ASSEMBLIES

Attach the convection heat outlets to the vertical extensions (optional, CENTURY supplied only). Then attach the outlet assembly to the top of the CENTURY utilizing the alignment guides. Position the convection heat outlets so the framing spacers around the convection heat outlets are vertically aligned with the framing spacer on the door. After positioning, tape and screw front and rear of convection heat outlets to unit with foil-backed tape.

The convection heat outlets must be installed without modification. These openings must not be used for ducts. Heat emitted from these convection heat outlets may exceed 500 degrees. The top of the convection heat outlets must be a minimum of 12" below the ceiling. NO combustibles or drops in ceiling may be installed closer than 6" in front of convection heat outlets.

When unit is operating in a convection mode, such as in times of power outage, blower failure, or when unit is installed without blowers as a free convection unit, or home has reached desired temperature, heat output of the CENTURY is emitted through these convection heat outlets. Outlets may be extended upward to within 12" of the ceiling.

CAUTION: DANGER, DAMPER BLADES MUST BE ADJUSTED. SEE STEP 15

STEP 9 - CHIMNEY FLUE DAMPER

Check damper operation to assure damper opens and closes easily and that damper is able to be locked in all positions prior to installing Metal Fab flue. Damper handle may be removed for installation of front wall face (requires 1/8" Allen wrench).

STEP 10 - FINAL CHECK BEFORE FRAMING IN FRONT OF CHASE

When you have your duct system installed to the bottom of each side of the CENTURY (in one side and out the other), you are ready to make final preparation for closing in the front wall of the chase. Let's take a few minutes to double check to see that you are ready:

1. Is the combustion air vented to the outside and are the joints taped?
2. If optional rear Cleanout system and extension is being used, is it through the wall, taped at slip joint and insulated? Make sure the extensions is firmly attached to your outside wall and sealed for air leaks.

3. Is the CENTURY sitting on a ½" concrete board such as Duroc or equal?
4. Has all combustible material been removed from the unit and around the chase?
5. Are the convection heat outlets installed and the framing spacers aligned directly over the doors' framing spacer? Make sure the bottom flange of the convection heat outlets has been slid under the side guides and attached to the main furnace with sheet metal screws. Check to Make sure the foil tape is installed front and back of each convection heat outlet where the lip on the assembly meets the unit. This provides an airtight seal. Check the dampers in the convection outlets after installation to be sure they move freely and are not stuck either open or closed.
6. Inspect the chimney inside the chase to make sure it has not been damaged during installation and that the fire stop (10AFSA) is properly installed.
7. Check the main damper control center top of the unit to make sure that when you pull out and Turn to adjust and push in to lock, the assembly works smoothly and is not binding or bent.
8. Vacuum and clean unit of any combustible materials such as wood chips, paper, sawdust, etc. Also clean chase area.
9. Check to make sure there is a minimum of 2" clearance between walls and unit; and that ceiling, minimum of 7'6" off floor, has been installed and sheet rocked.
10. After these checks have been made, you are ready to frame in the front of the unit.
Illustrations G & H show a typical framing plan.

STEP 11 - FRAMING FRONT OF CHASE

- A. First determine the finish material to be used on the front of your CENTURY unit. Whether the finished front is to be sheetrock, artificial stone, or brick, this material must not extend further out than the turned up lip on the framing spacers around the glass door and the convection heat outlets. Calculate back from the finished front to determine the location of your metal stud wall. Example: If you use an approximately 2" thick rock material attached to ½" Duroc or equivalent, your stud wall would be placed 2 ½" behind the framing spacer. When examining the front framing spacer around the door, you will find there is a 4" area for the wall to sit on. Therefore, your stud wall must be turned flat to have adequate room for the wall when using a 2" rock material. The 1 ½" stud wall, ½" Duroc or equivalent, and 2" rock add up to 4".
- B. Use the framing spacers on the side of the doors and convection outlets to vertically align the wall sections. Then frame between these two wall sections, across the top of the framing Spacer, above the glass doors above and below the framing spacers around the convection Heat outlets, and at the ceiling. Short pieces may be installed vertically for support in the Center section per *Illustration G*.

CAUTION: NO COMBUSTIBLE MATERIALS MAY BE USED IN THE CHASE.

- C. After the stud wall is installed, remove all combustibles from the unit and chase area. You are now ready to install the ½" Duroc or equivalent or type X sheetrock to the front of the unit; and add the brick, stone, or other finish material. Remember, the finished front must not extend beyond the lip on the framing spacers. The inside front wall need not be sheet rocked.
- D. Install 4" X 8" chase heat return grill 2" below the ceiling of the chase in the finished wall.
Illustration G.
- E. Finished front which will extend in front of the lip on the framing spacers on the door and Convection outlets must comply with *Illustration H*.

D. Install 4" X 8" chase heat return grill 2" below the ceiling of the chase in the finished wall.

Illustration G

STEP 12 - HEARTH

The hearth is part of the CENTURY package, which attaches to the ash box by the welded clips on the ash box. The lip on the center hearth sets in these clips. You may extend the width of the ash box by building extensions from non-combustible material. If you extend the hearth to the sides with combustible material, you must maintain a 2" clearance from the hearth as well as the main CENTURY firebox. Metal hearth extensions are available as an option. You are now ready to apply your final surface to the metal hearth and extensions. This final surface must be made from non-combustible material. **NO EXCEPTIONS.** (See glossary for listing of combustibles and non-combustibles, Page 28, #13.) *Illustration C.* Leave a $\frac{3}{4}$ " mortar joint next to the door to service the combustion air control, if necessary.

If you are not tying your unit into the duct work, you must provide 400 square inches of air to enter the CENTURY from the hearth, bottom side of unit, or from the basement. *Illustration C.*

CAUTION: DO NOT RAISE THE UNIT TO A HEIGHT THAT WOULD PUT THE TOP OF YOUR CONVECTION AIR OUTLETS CLOSER THAN 12" FROM THE CEILING.

STEP 13 - MANTLE - Wooden mantle may be installed 38" to 46" from the steel hearth.

CAUTION: NO FLAMMABLE MATERIALS MAY BE LEFT ON THE MANTLE NEAR THE CONVECTION OUTLETS DURING OPERATION OF THE UNIT.

STEP 14 - CONVECTION OUTLETS

The convection outlets may be raised to within 12" of the ceiling, but not any closer. The higher the convection outlets are raised, the more heat will be emitted from the CENTURY.

STEP 15 - TUNING THE CONVECTION OUTLET DAMPER BLADES

Damper blades may require balancing. It is critical that the convection damper blades remain open when the CENTURY is in the free convection mode. Check to make sure that, when the CENTURY is fired at its maximum, the damper blades do not flutter or close. To check this operation, remove the screws holding on the grill. Observe the damper blade for movement. The damper should be stationary in the open position when the unit is burning hard in the convection mode and closed when the blower is on in the furnace mode. Danger of fire may occur if the damper closes when the unit is in the free convection mode, with the blower off. Add or delete weight to damper to custom tune for your application. **CAUTION:** After tuning the dampers, make sure that the damper opens and closes smoothly and does not stick in either the open or closed position.

ILLUSTRATION G

CAUTION

When enclosing the Century the entire chase & ceiling must be sheetrocked. There must not be any protrusion inside chase wall, such as wall stiffeners, etc., below the ceiling.

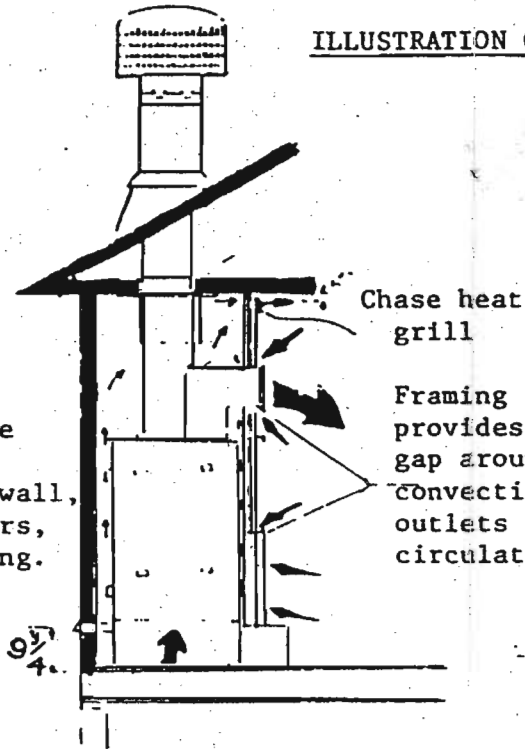
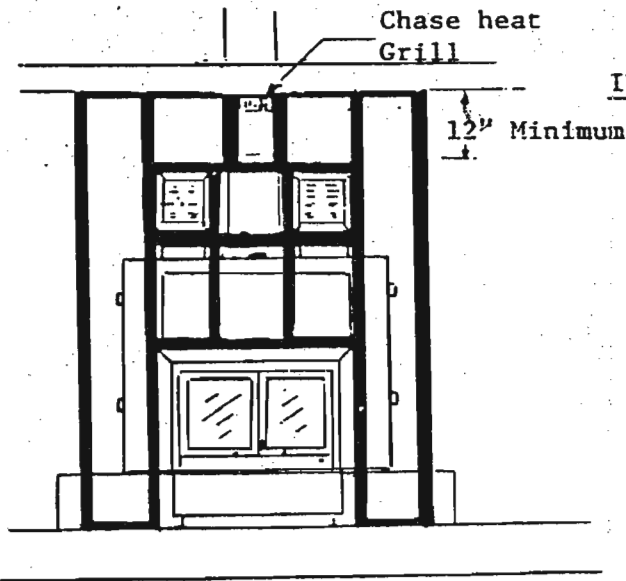

ILLUSTRATION H



CAUTION: IF YOU PLAN TO INSTALL STONE OR BRICK VENEER WHICH WOULD EXTEND IN FRONT OF THE TRIM, YOU MUST MAINTAIN THE 3/4" AIR GAP AROUND THE TRIM ON THE CONVECTION OULETS FOR PROPER AIR CIRCULATION.

A TEMPORARY WOOD 1" X 6" FRAME SHOULD BE BUILT NEXT TO THE TRIM AROUND THE CONVECTION OUTLETS. IF YOUR FINISHED FRONT WILL EXTEND IN FRONT OF THE FRAMING SPACER, PAINT THE PLYWOOD TO WHICH THE FINISH MATERIAL WILL BE ATTACHED BLACK BEFORE INSTALLING THE TEMPORARY WOOD FRAMING SPACER. (AFTER THE FRONT HAS BEEN STONED OR BRICKED, YOU MUST REMOVE THE TEMPORARY WOOD FRAMING SPACER.) THIS LEAVES A 3/4" AIR GAP AROUND THE TRIM FOR AIR CIRCULATION. LEAVING THIS TEMPORARY WOOD FRAMING SPACER INSTALLED WOULD CAUSE A FIRE. HEAT EMITTED FROM THE CONVECTION HEAT OUTLETS MAY EXCEED 500 DEGREES, WHICH IS FAR ABOVE THE FLASH POINT TEMPERATURE OF WOOD. *Illustration W.*

AIR MUST ENTER THE CHASE THROUGH THIS 3/4" AIR GAP LEFT BETWEEN THE STONE OR BRICK AND THE TRIM AROUND THE DOOR AND CONVECTION HEAT OUTLETS. THIS AIR IS USED TO COOL THE OUTER SHELL, AND RETURNS TO THE ROOM THROUGH THE CHASE HEAT GRILL WHICH IS LOCATED 2" BELOW THE CEILING IN THE CHASE PER *Illustrations G & H.*

ILLUSTRATION W

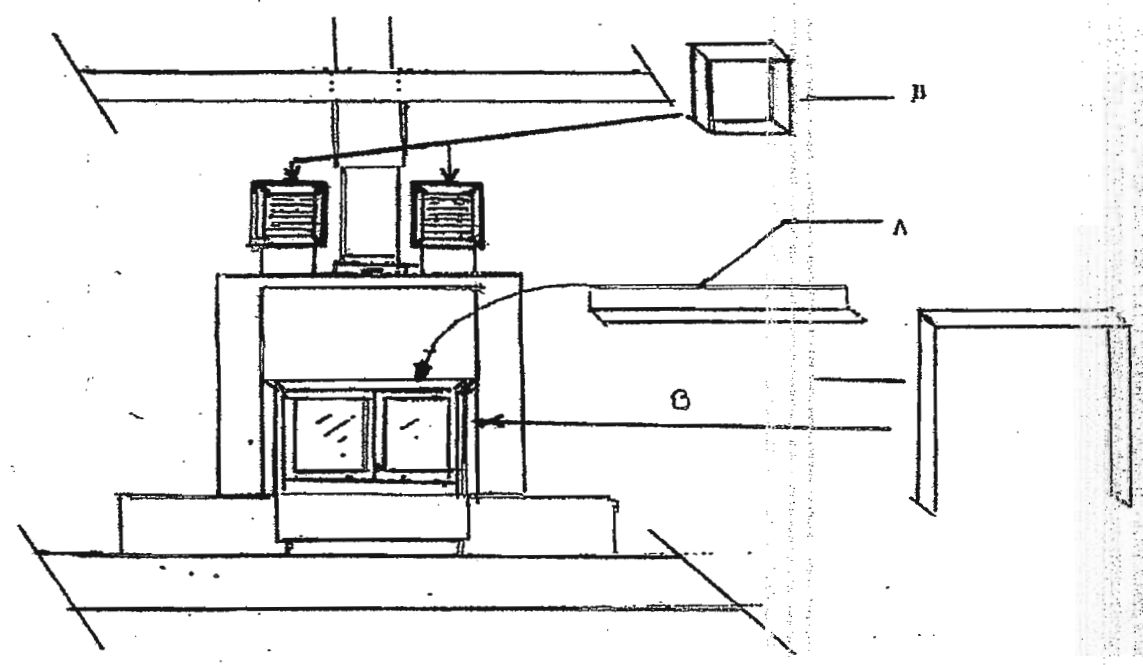

12

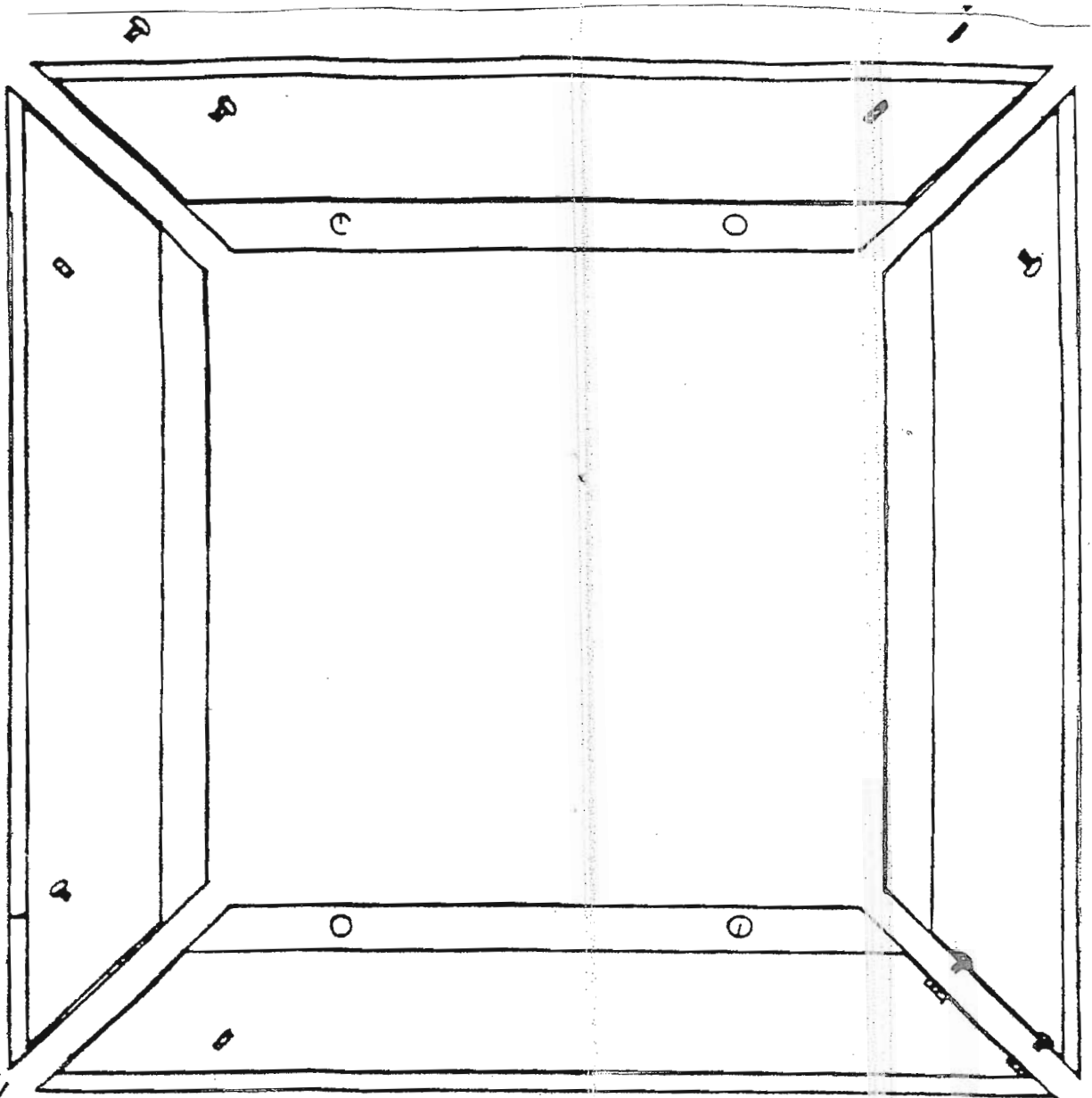

ILLUSTRATIC

6x32 1/4"
machine screws

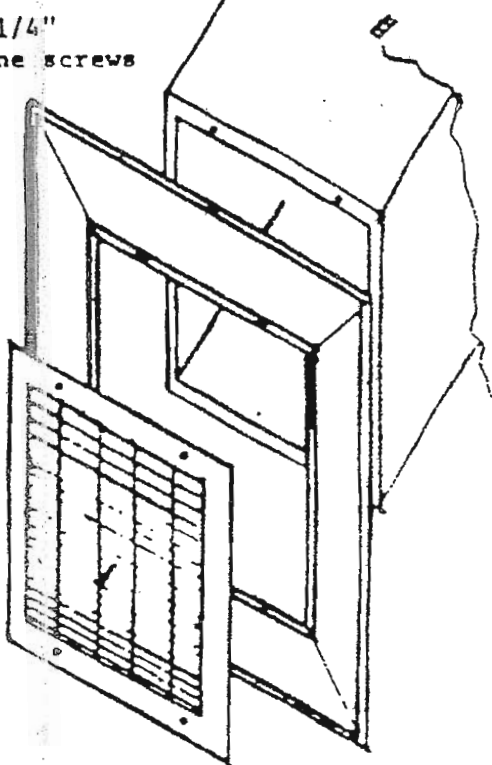

To install trim on convection air outlet, remove 10" X 10" grill and place in trim, matching holes together. Reinstall grill with trim on convection air outlets.

IF USING OPTIMAL BRASS TRIM, DO NOT REMOVE PLASTIC PROTECTIVE FILM FROM SURFACE UNTIL CONSTRUCTION IS COMPLETED.

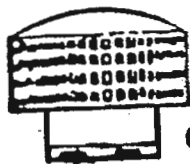

CONTEMPORARY CAP



STORM COLLAR

ADJUSTABLE FLASHING

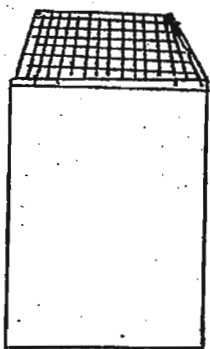

CHIMNEY PIPE

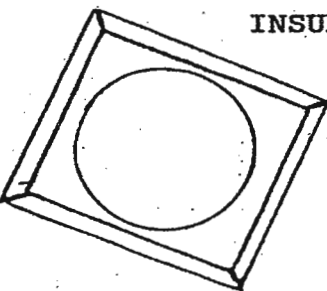

INSULATION SHIELD (optional)

FIRESTOP

ANCHOR PLATE

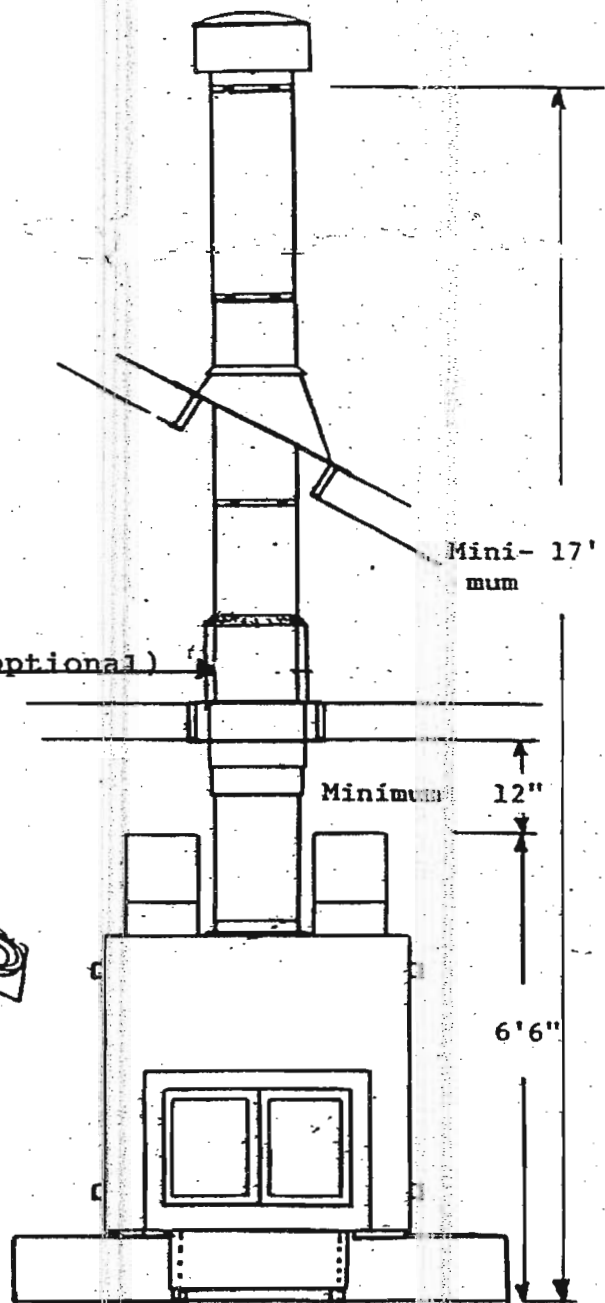

C. CHIMNEY PARTS LIST:

- 1 - Contemporary Cap 10TGC
- 1 - Storm Collar 10TGSC
- 1 - Adjustable Flashing 10TGF
- 1 - Radiation Shield 10TGRSH (Optional)
- 1 - Firestop 10TGFSa
- 1 - Anchor Plate

Chimney Pipe

- 4 - 36" length 10TG36.
- 24" length 10TG24 (Optional)
- 18" length 10TG18 (Optional)
- 12" length 10TG12 (Optional)
- 6" length 10TG6 (Optional)

Angles

- 10TGA15 & 10TGA30 (Optional)

10 TGIS Insulation Shield (optional)

BASIC PIPE PACKAGE INCLUDES:

- 4 ea 10 TG 36
- 1 ea storm collar 10 TGC
- 1 ea 10 TGFT FLASHING
- 1 ea 10 TGGFSA FIRESTOP
- 1 ea 10 TGC CAP
- 1 ea ANCHOR PLATE

ILLUSTRATIONS AND DIMENSIONS

A B C D

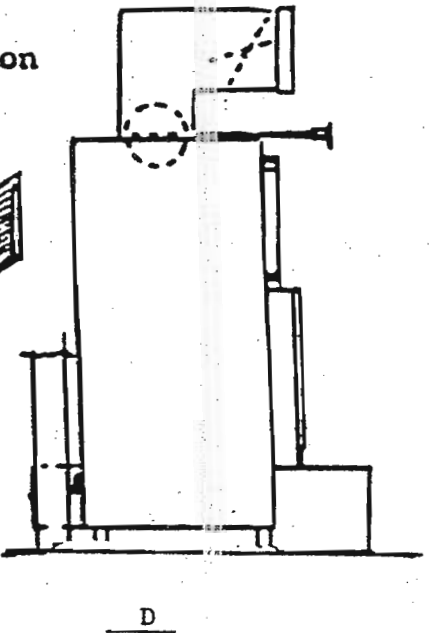
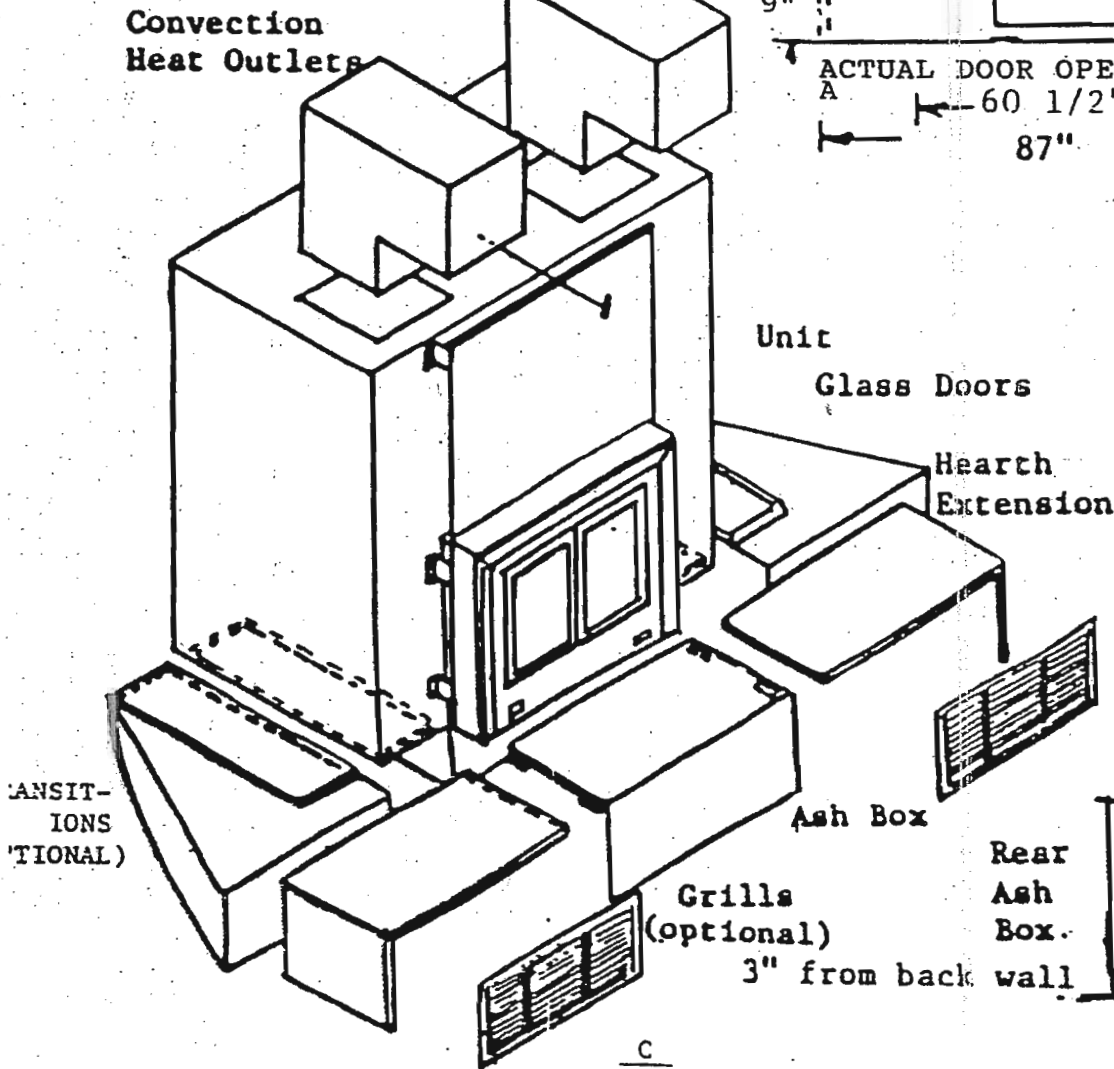
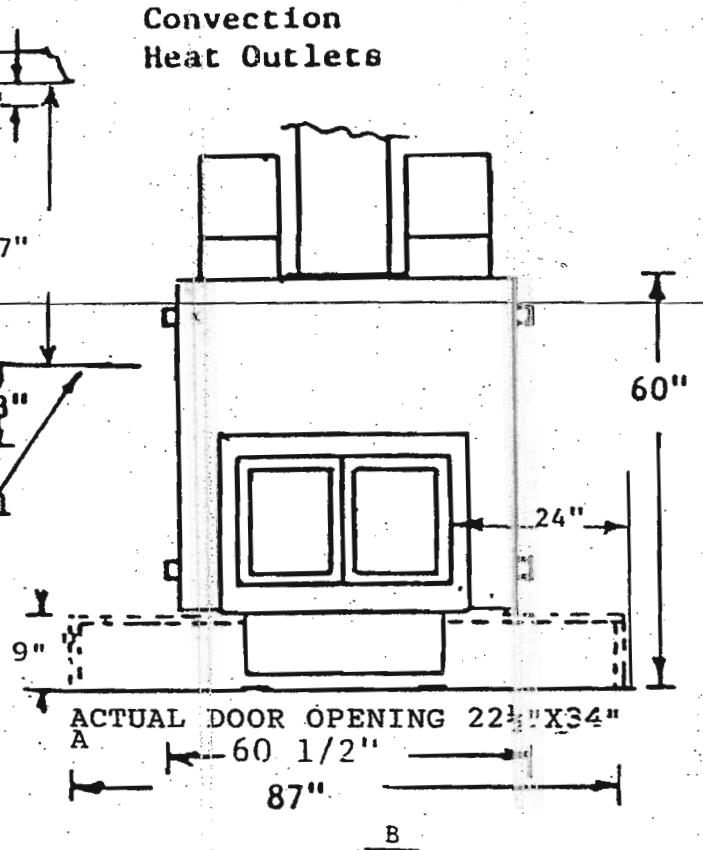
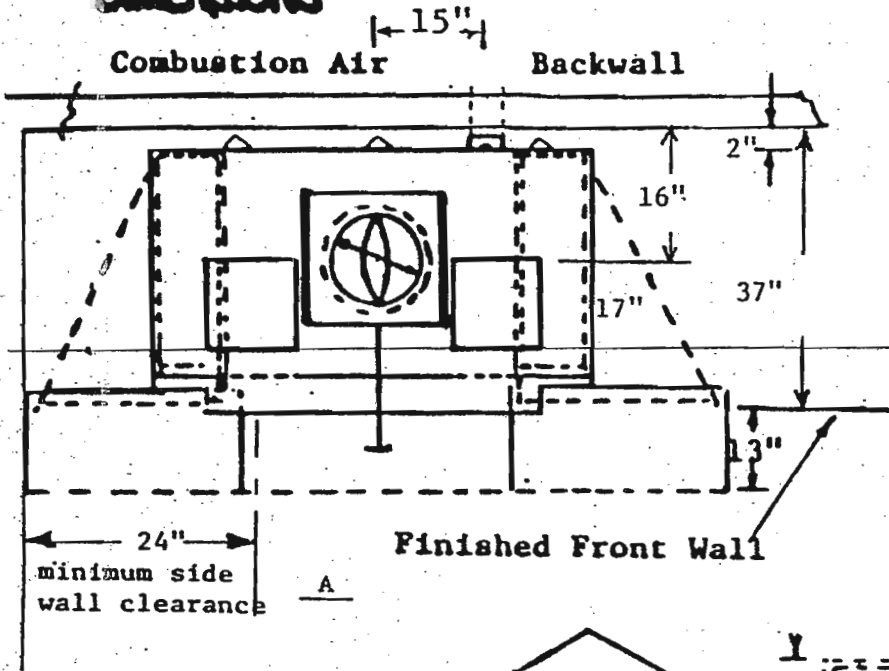

TRANSITION (OPTIONAL)

ILLUSTRATION V

OFFSET TABLE

REVISIONS

REV. NO.

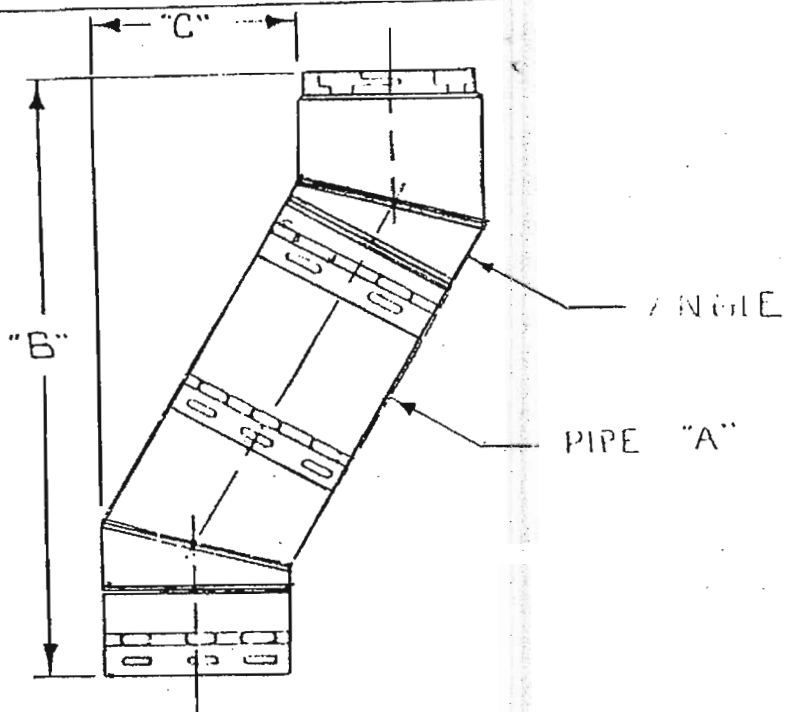

A		15° Angle		30° Angle	
Dim	No. Pcs.	B	C	B	C
0	0	18 7/16"	2 1/4"	20 3/16"	5"
6	1	22 13/16"	3 3/8"	24 1/16"	7 1/4"
12	1	28 5/8"	4 5/16"	29 1/4"	10 1/4"
18	1	34 3/8"	6 1/2"	34 7/16"	13 1/4"
24	1	40 3/16"	8 1/16"	39 5/8"	16 1/4"
30	2	44 1/2"	9 1/4"	43 1/2"	18 1/2"
36	1	51 3/4"	11 3/16"	50 1/16"	22 1/4"
42	2	56 1/8"	12 3/8"	53 15/16"	24 1/2"
48	1	63 3/8"	14 1/4"	60 7/16"	28 1/4"
54	2	67 3/4"	15 7/16"	64 3/8"	30 1/2"
60	2	73 1/2"	17"	69 1/2"	33 1/2"
66	2	79 11/16"	18 1/2"	74 3/4"	36 1/2"
72	2	85 1/2"	20 1/16"	79 15/16"	39 1/2"
78	3	89 7/16"	21 1/4"	83 13/16"	41 3/4"
84	2	96 11/16"	23 3/16"	90 5/16"	45 1/2"
90	3	102 3/8"	24 3/8"	94 3/16"	47 1/2"
96	2	108 1/4"	26 5/16"	100 11/16"	51 1/2"

VARIOUS HEAT DELIVERY SYSTEMS

There are two basic ways the CENTURY FIREPLACE FURNACE may be used to heat your home:

1. CONVECTION HEAT

The convection heat method is the simplest method for installing your CENTURY and is adequately heating many homes of over 1,600 sq. ft.

With this method, no fans are required. The CENTURY draws air in from both sides of the bottom, (openings for optional grills must be left in hearth) and this air is heated and discharged from the convection heat outlets located at top of the CENTURY per *Illustration R*. Simplicity and efficiency are the benefits of the free convection method. The main drawback of this method is that heat distribution to the furthest points of your home is not as even.

If your home is equipped with a good, tight basement, a simple modification of the convection system should be considered. By dropping a duct below the floor from both sides of the CENTURY per *Illustration S-1* to draw air from the basement area, then cutting return air vents in each room, the entire home will be heated much more evenly. As air is pulled from the basement and heated, the air which is removed from the basement is replaced by air from each room. The heated air emitted from the convection heat outlets moves to replace the air in each room as it is drawn to the basement. This provides a nice circulation for larger homes with good, tight basements. This method also helps keep a warm, dry basement.

2. DUCTED HEATING SYSTEM

The CENTURY is designed and approved to be installed in a central duct system. Various combinations may be used. If the CENTURY is to be installed in a ducted system, the duct system must be engineered and installed per our instructions, by a competent, licensed heating company.

A. COMMON DUCT WITH EXISTING FORCED AIR FURNACE

The CENTURY has been tested with a minimum of 80,000 BTU and 1,200 CFM gas backup furnace or the equivalent, and a maximum of 175,000 BTU and 2,000 CFM blower system or equivalent. The CENTURY will increase the static pressure at 2,000 CFM of air at 76 degrees F., .14 static. This small increase in static pressure should not create a problem for your duct fabricator. When your heating contractor designs your duct system, it is critical that the total system be designed to no more than a .3 static pressure to insure quiet operation. When ducts are to be run overhead, you must use CENTURY'S 180 degree elbow with anti-siphon valve #2220.

Using this method, air from the existing furnace would be discharged into one side of the bottom of the CENTURY. This system must have a minimum output, at the outlet registers, of 1,200 CFM. The air would be heated by the CENTURY and discharged out the bottom of the opposite side of the CENTURY. You would use an optional Thermostat to control the blower on the existing furnace only.

The heating portion of the existing furnace would be used only as backup to the CENTURY when the CENTURY was not fired. The control between the two units

may be hooked up to function automatically. If your home has central air, a by-pass valve #2210-1 may be purchased from your CENTURY dealer, or made by your heating contractor. Air-conditioned air should not be run through the CENTURY. This usually provides the best and least expensive method of ducting provided your backup furnace can be located below or close to the CENTURY.

CAUTION - DANGER: NEVER FIRE THE CENTURY IF THE BY-PASS VALVE IS IN THE CLOSED (AIR-CONDITIONING) POSITION. AIR MUST BE AVAILABLE FROM THE DUCT SYSTEM TO AVOID OVERHEATING, WHICH COULD CREATE A FIRE HAZARD.

IF ELECTRIC OPERATED DAMPERS ARE USED, DAMPERS SHOULD BE CLOSED ONLY WHEN IN AIR-CONDITIONING MODE. IF POWER OUTAGE OCCURS, THE NORMAL POSITION OF THE DAMPER WOULD BE OPEN TO ALLOW INCOMING AIR FROM THE DUCT SYST.

CAUTION: NEVER SUCK AIR OUT OF THE CENTURY - IT WILL NOT WORK. THE HEAT OUTLETS WILL ONLY WORK BY BLOWING AIR INTO THE CENTURY AND PRESSURIZING THE UNIT. THIS IS A MUST. ALSO, IN THE EVENT A CRACK SHOULD EVER DEVELOP IN THE HEAT EXCHANGER, YOU WILL PULL SMOKE INTO THE HOME - A VERY DANGEROUS SITUATION.

B. COMMON DUCT - SEPARATE BLOWERS

In some installations, especially when tying into an existing system, it is impractical to run the output of the existing furnace directly into the CENTURY. In this case, a separate blower may be used. This blower system must have a minimum output of 1,200 CFM at the outlet registers. A larger CFM blower may be required for proper air delivery to the home. Air delivery system must be engineered by a competent duct layout company. The blower box housing the optional blower is discharged into one side of the CENTURY at the bottom, and is discharged from the bottom of the other side. The output from the CENTURY'S 9" X 26" outlet is then tied into the largest part of the main trunk line.

A lightweight aluminum back-draft damper should be installed at the outlet of the existing furnace. This back-draft damper blows open when the existing furnace is in operation.

C. SEPARATE DUCT SYSTEMS

An entire separate duct system may be installed for the CENTURY. This system would use a blower as discussed in Section B Above.

Attached in Illustrations r through U are the only approved methods with which ducts may be run from the CENTURY. The flow through the CENTURY is non-directional; that is, air may enter from either bottom side of the CENTURY and exhaust from the opposite bottom side.

Duct systems are divided into three basic categories, determined by where the auxiliary furnace or blower is located.

1. Backup furnace or blower located below the floor as shown in *Illustrations S-1 through S-5*.

A. *Illustration S-1* is for homes with backup furnace at blower and supply ducts below floor (without air conditioning).

B. *Illustration S-2* is for homes with backup furnace or blower and supply ducts below

floor (with air conditioning). By-pass valve kit #2210-1 available from your CENTURY dealer.

C. *Illustration S-3* is for homes with the backup furnace or blower below the floor, and ductwork in the ceiling. CENTURY'S 180 degree elbow with anti-siphon valve #2220 must be used.

D. *Illustration S-4* is for homes with the backup furnace or blower below the floor, and output from the front or rear of the CENTURY.

E. *Illustration S-5* is for homes with backup furnace or blower below the floor and the Output from the CENTURY to the side.

2. Backup furnace or blower located at same floor level as CENTURY.

A. *Illustration T-1* is for homes with backup furnace or blower on same level as the CENTURY, and output from the CENTURY front or rear - not ducted (not for air conditioning application).

B. *Illustration T-2* is for homes with backup furnace or blower on the same level as the CENTURY and output from the CENTURY to the side - not ducted (not for air conditioning application).

C. *Illustration T-3* is for homes with backup furnace or blower on the same level as the CENTURY, and output from the CENTURY below the floor - ducted (without air conditioning).

D. *Illustration T-4* is for homes with backup furnace or blower on the same level as the CENTURY and ductwork overhead. CENTURY 180 degree elbow with anti-siphon valve must be used. Kit #2220 is available from your CENTURY dealer (not for air conditioning application).

3. Backup furnace or blower in attic. (This system creates more static pressure. Heating contractor should size ducts and blower accordingly. The .3 static should be maintained for quiet operation and proper air flow.)

A. *Illustration U-1* is for backup furnace or blower overhead and supply ducts below floor (not applicable for air conditioning). Use CENTURY 180 degree elbow with anti-Siphon valve #2220.

B. *Illustration U-2* is for backup furnace or blower overhead and supply ducts overhead. Use CENTURY 180 degree elbow with anti-siphon valve #2220. This system may be installed with an air conditioning by-pass valve system. It #2210-1 may be purchased from your CENTURY dealer for some overhead applications.

C. *Illustration U-3* is for backup furnace or blower overhead and output from the CENTURY discharged front or rear of the CENTURY. Use CENTURY 180 degree Elbow with anti-siphon valve #2220 (not applicable for air conditioning).

D. *Illustration U-4* is for backup furnace or blower overhead and output from the CENTURY discharged to the side. Use 180 degree elbow with anti-siphon valve #2220 (not applicable for air conditioning).

TWO STATE THERMOSTAT FOR GAS OR ELECTRIC FURNACE

A two stage thermostat may be used for complete automated control between the CENTURY and a gas or electric furnace. Stage one is designed to utilize the blower from your existing furnace as the propulsion system for the CENTURY. If the CENTURY is not adequately fired to heat your home to the desired temperature, the existing furnace will come on to maintain the temperature.

THERMOSTAT FOR GAS/ELECTRIC FURNACE APPLICATION IF 57-306

FOR COMBUSTION BLOWER

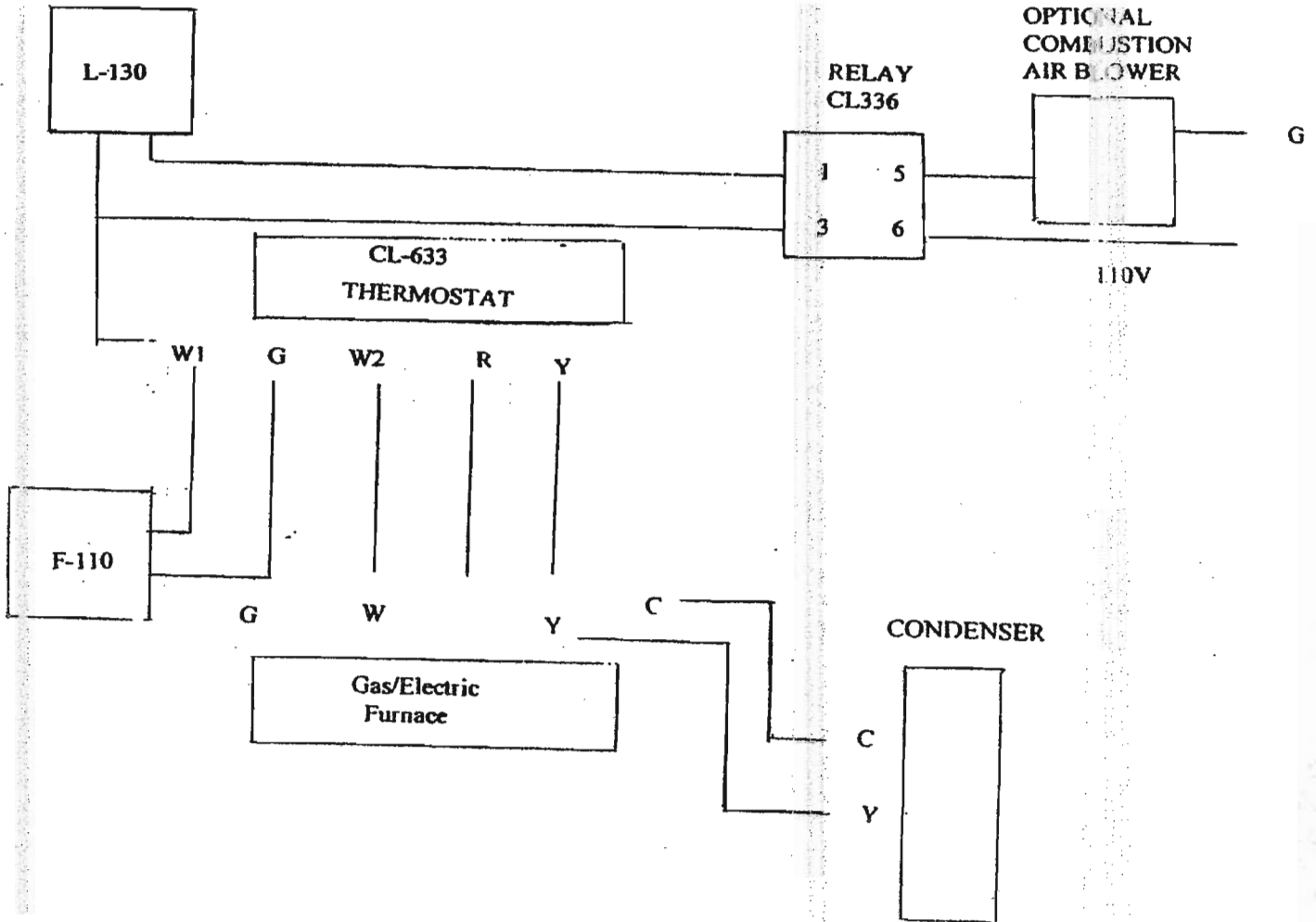

THREE STAGE THERMOSTAT FOR HEAT PUMP

A three stage thermostat may be used for complete automatic control between the century and the heat Pump. Stage one (W-1) will operate the blower only when the home calls for heat. Stage 2 (w-2) will operate the heat pump, and stage 3 (w-3) will operate the back-up heat strips.

THERMOSTAT FOR CENTURY/HEAT PUMP APPLICATION Y594W1014

FOR COMBUSTION BLOWER

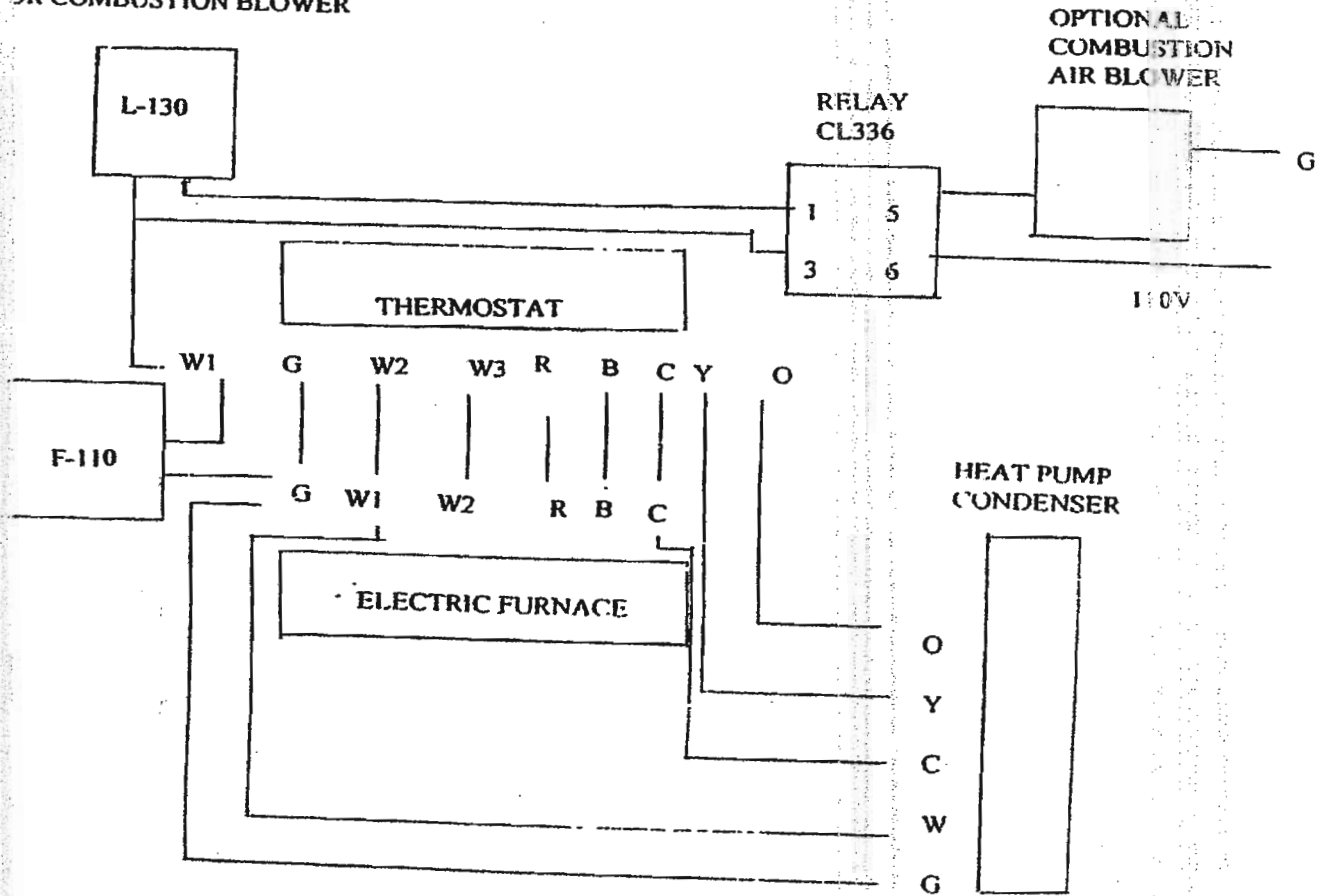

CHANGING FROM GAS TO WOOD

Changing the fuel system takes about five minutes.

1. Shut unit down and allow the CENTURY to cool.
2. Remove the two screws just inside the glass doors and remove the cover to expose the gas valve.
3. Turn off the gas shut-off valve by turning the handle 90 degrees to the line. Make sure the external shut-off valve near the hearth is also closed.
4. Disconnect the gas line from the shut-off valve by turning the gas line connection counter clockwise.
5. Re-install the ½" pipe cap on the shut-off valve to insure that no contaminants enter the line and that gas could not leak from the unit if the valve should fail. Soap check for leaks.
6. Pull the spade clips apart to disconnect the two low voltage lines running to the thermostat.
7. Lift out the log set and gas valve in one piece and store until ready to use again.
8. Replace the gas valve cover and replace the two screws.
9. Place the air tube with the log retainer attached over the opening to the gas valve cover.
10. Remove safety stop from damper.

CHANGING FUEL FROM WOOD TO GAS

CAUTION: NEVER OPERATE GAS WITHOUT GAS LOGS INSTALLED. EXPLOSION AND/OR FIRE MAY RESULT.

1. Shut unit down and allow the CENTURY to cool.
2. Remove the air tubes with log retainers attached.
3. Clean the ash from the firebox.
4. Remove the two screws just inside the door and remove the cover for the gas valve.
5. Remove ½" cap from gas line (leave cap in the gas valve compartment so cap may be reinstalled when removing gas logs.)
6. Place the gas log system in the fire box.
7. Hook up the gas line by attaching the gas line to the gas shut-off valve. Tighten valve sufficiently to prevent leakage.
8. Turn the gas valve on by turning the gas valve to 90 degrees to be parallel with the gas pipe.
9. **WARNING:** Check for leaks by using soap and water to check for bubbles. If the line leaks, tighten and recheck. If leak persists, shut valve off and do not use until repaired.
10. Turn the wall thermostat off before connecting the low voltage thermostat lines.
11. Connect the low voltage thermostat lines by sliding the spade clips together.
12. Turn the valve to pilot, hold the safety down and light the pilot per the instructions for your gas logs. After the pilot lights, continue to hold the safety down for one minute or until the pilot stays lit.
13. Turn the gas valve to "on".
14. Replace the gas valve cover and install the two screws. **WARNING: If using LP, the two air distribution openings in the gas valve cover must be sealed to the firebox. If this is not sealed, gas may accumulate in the gas valve compartment and explosion may occur.**
15. **WARNING:** Always leave the damper open when the gas logs are in the fireplace. Attach safety stop on damper to prevent closing.
16. Doors on the CENTURY may be open or closed when in use, but, when closed, they prevent heat from the home from escaping up the flue.
17. Set the wall thermostat to your desired temperature.

NOTE: The installation of your gas system into the CENTURY must be made by a qualified plumbing or heating contractor. Complete instructions for installation are included with your gas log kit. Once this system is installed, changing from one fuel to another should require approximately five minutes. It is recommended that you have your plumbing or heating contractor make this change when required.

DIMENSIONS FOR VARIOUS HEAT DELIVERY SYSTEMS

	A	B	C	D	E	F	G	H	I	J	K	L	M	N	O	P	Q
R	87	60 1/2	9	60	78	90	18	12	46	34 1/2	41 1/2	26	13	13	20	6	66
S-1	--	"	"	"	"	"	"	"	"	"	"	"	"	"	"	"	"
S-2	--	"	"	"	"	"	"	"	"	"	"	"	"	"	"	"	"
S-3	71	"	"	"	"	"	"	"	"	"	"	"	"	"	"	"	"
S-4	74	"	"	"	"	"	"	"	"	"	"	"	"	"	"	"	"
S-5	--	"	"	"	"	"	"	"	"	"	"	"	"	"	"	"	"
T-1	74	"	"	"	"	"	"	"	"	"	"	"	"	"	"	"	"
T-2	--	"	"	"	"	"	"	"	"	"	"	"	"	"	"	"	"
T-3	--	"	"	"	"	"	"	"	"	"	"	"	"	"	"	"	"
T-4	71	"	"	"	"	"	"	"	"	"	"	"	"	"	"	"	"
U-1	71	"	"	"	"	"	"	"	"	"	"	"	"	"	"	"	"
U-2	78	"	"	"	"	"	"	"	"	"	"	"	"	"	"	"	"
U-3	85	"	"	"	"	"	"	"	"	"	"	"	"	"	"	"	"
U-4	71	"	"	"	"	"	"	"	"	"	"	"	"	"	"	"	"

ILLUSTRATION R

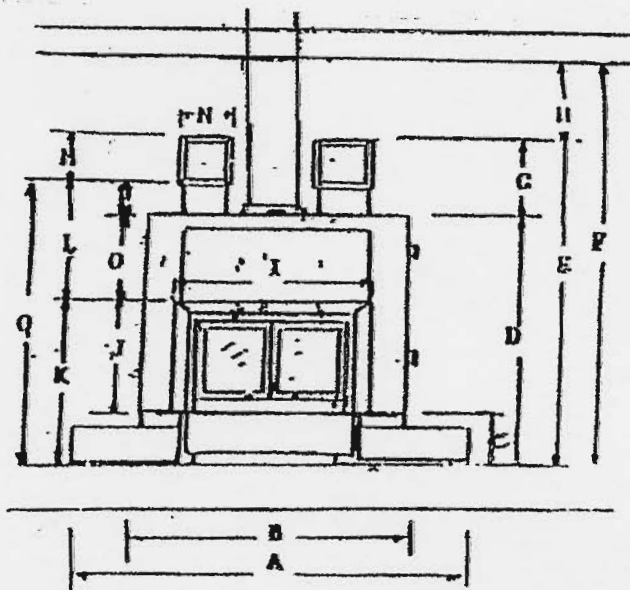

ILLUSTRATION S-1

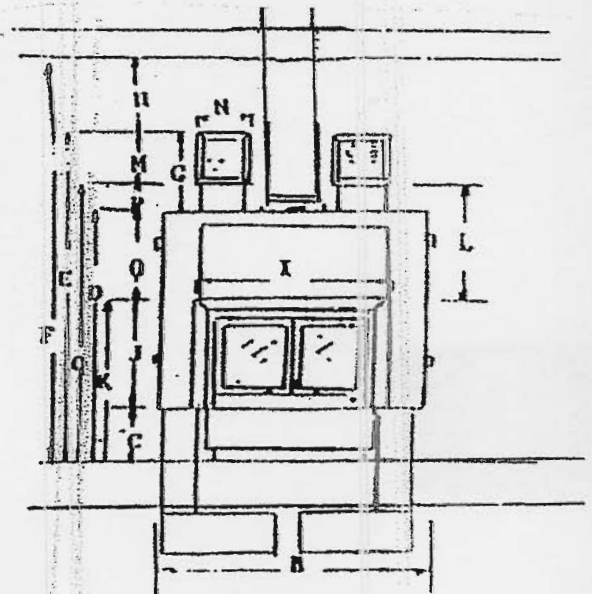

ILLUSTRATION S-2

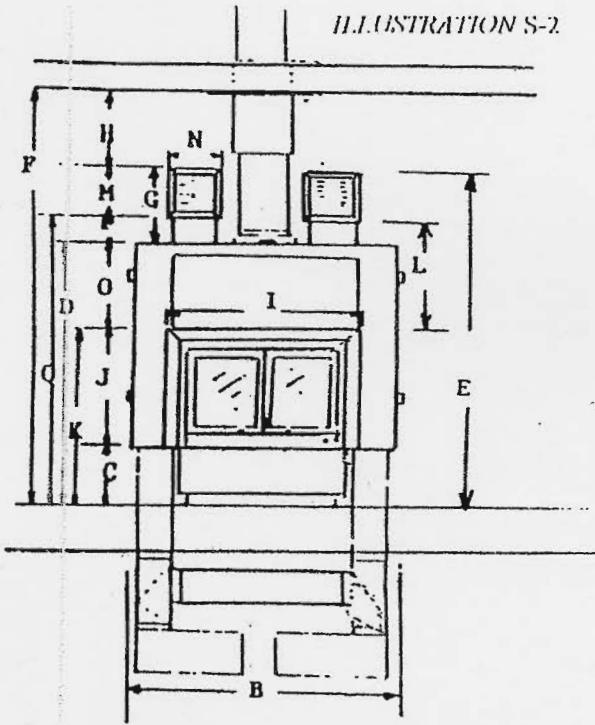
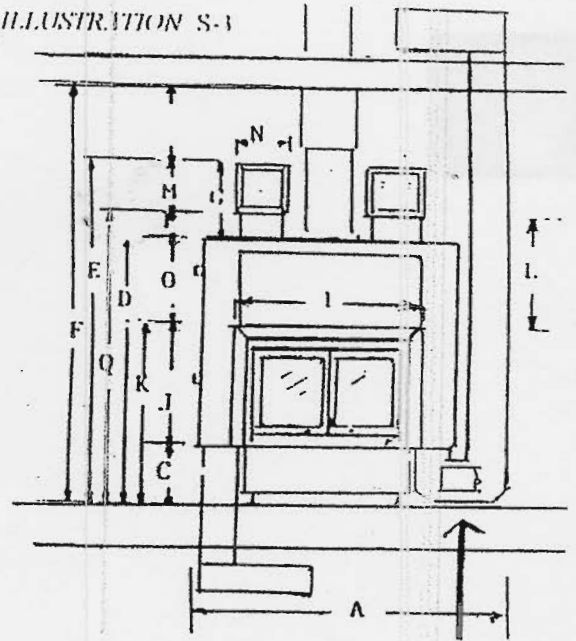

ILLUSTRATION S-3



Absolutely must use air-flow damper

ILLUSTRATION S-4

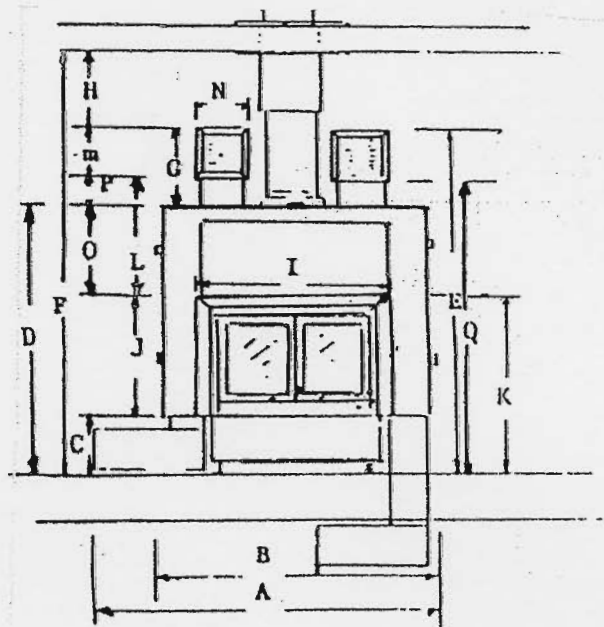

ILLUSTRATION S-5

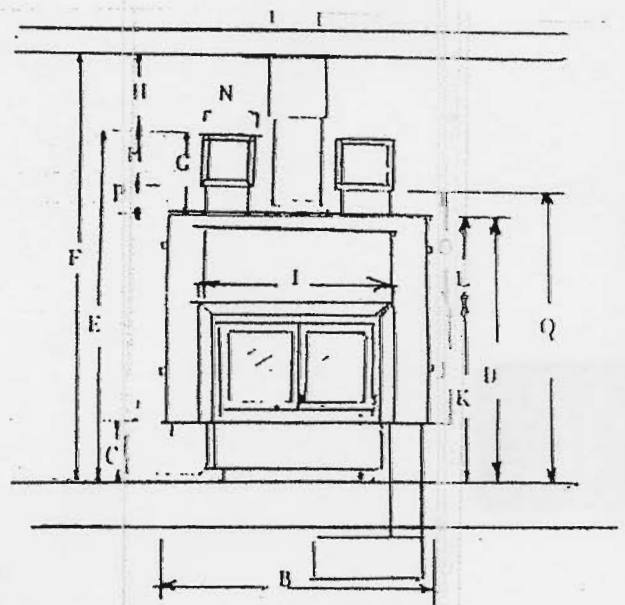
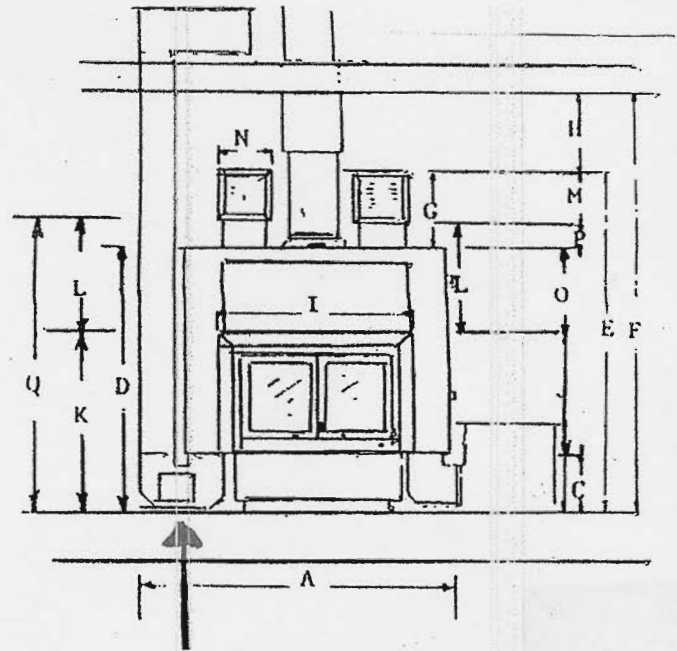
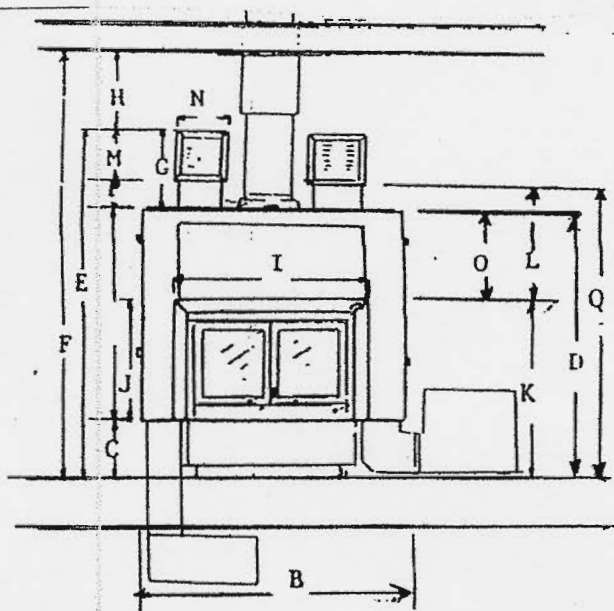
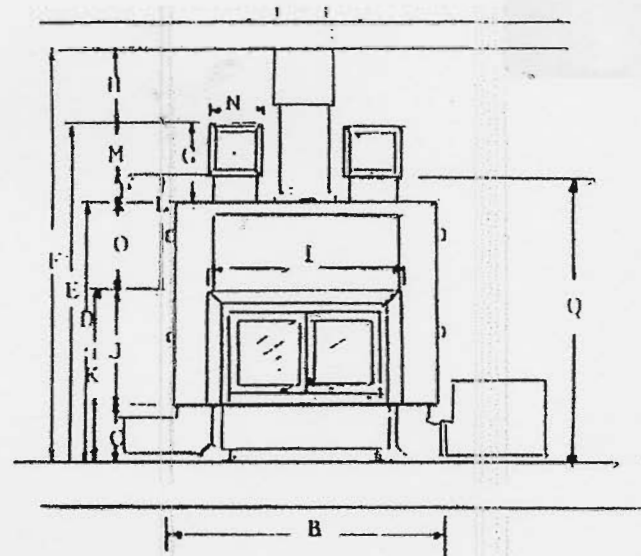
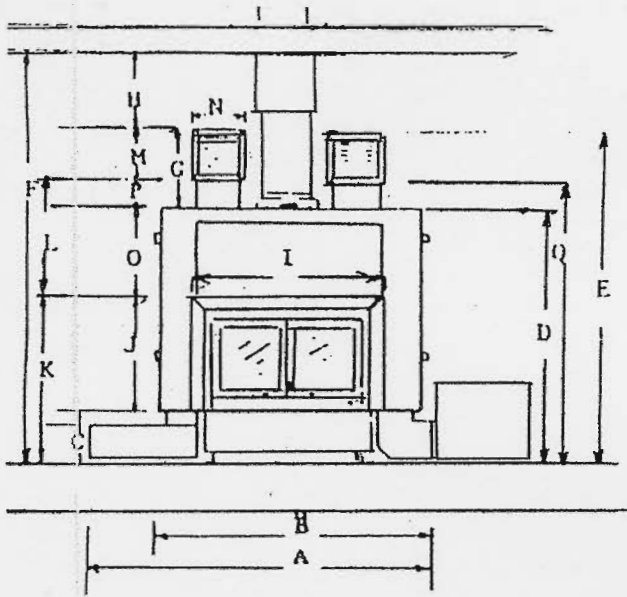

ILLUSTRATION T-1

ILLUSTRATION T-2



***Absolutely must use air-flow damper

ILLUSTRATION U-1

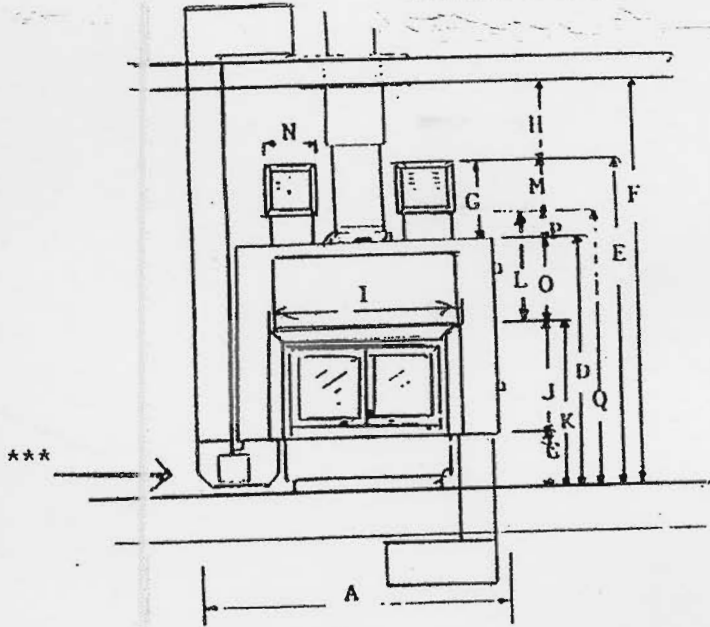

ILLUSTRATION U-3

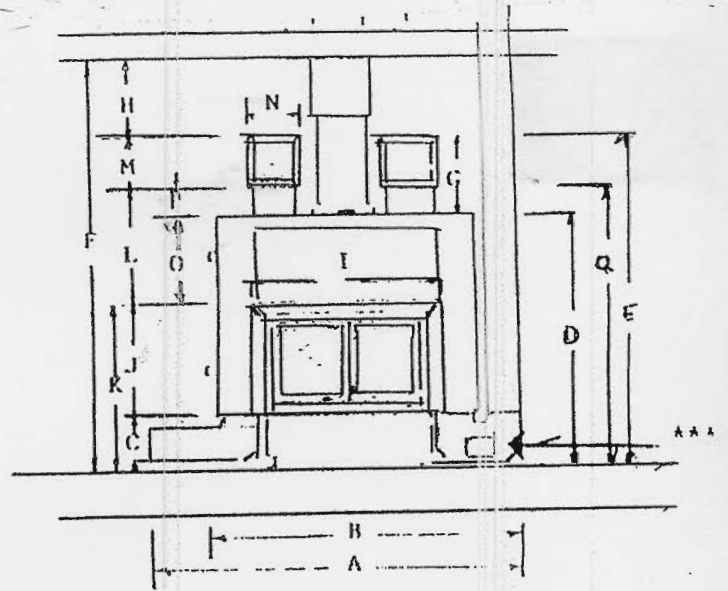

ILLUSTRATION U-2***

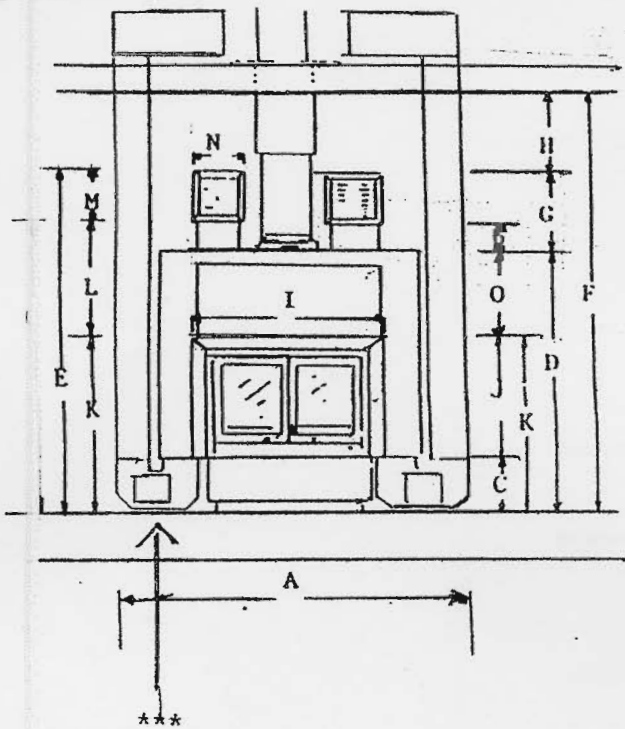
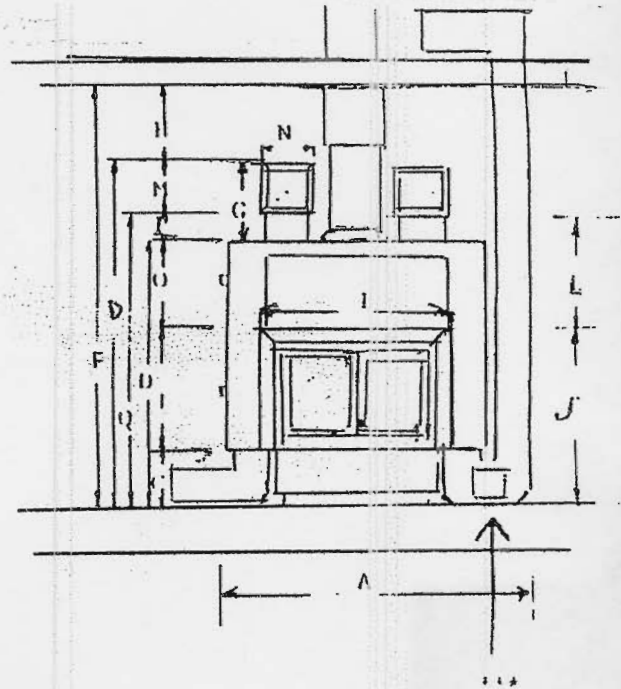

ILLUSTRATION U-4***



***Absolutely must use air-flow damper

GLOSSARY OF TERMS

1. Ash Pit Rear Door and Extension: Your CENTURY is equipped with a center cleanout and a bolted on plate at the center rear of the ash pit. Kit #2225 provides a rear cleanout cast iron door and an adjustable extension, between 7" and 12". Also included in the kit are insulation and metal tape for the slip joint.
2. By-Pass Valve: The optional 3 piece by-pass valve kit consists of 2 valves and connection duct that connects the 2 valves. This valve is used when the home is equipped with central air. This kit is needed when the conditioned air would pass through the CENTURY during the summer. If the valve is not used, the cold air would condense on the CENTURY, creating rust and shortening the life of the CENTURY. The valve kit may be used both below the floor and overhead. Below the Floor Kit #2210 Overhead Kit #2210-1. Some applications for by-pass valves may need to be field fabricated. Ask your CENTURY dealer.
3. Center Cleanout: The CENTURY is equipped with a center ash cleanout. By removing the ash dump door, located inside the firebox, and 2 firebrick directly behind it, you will find a removable metal plate that may be lifted out, exposing the cleanout hold in the top of the ash pit. Ashes may be removed through this cleanout. The ash pit is large enough that removal of ashes is required only a few times a year.
4. Chase Heat Return Grill: This grill is to be located center of the front of the chase 2" below the ceiling in the chase. Its function is to allow the heated air out of the chase. As this air enters the chase around the framing spacers around door and convection heat outlets, this air cools the CENTURY outer shield and returns to the room through the chase heat grill.
5. Convection Heat Outlet Assembly with Pressure Operated Damper: CENTURY is equipped with two assemblies furnished standard, which are to be mounted on top of the unit per instructions. The pressure operated dampers, which are located behind the grills, are normally open for free convection operation. When air is blown into the CENTURY (CAUTION: not sucked from the CENTURY) the dampers close and allow air to be forced through the duct system. These dampers automatically open when blower is off. These outlets must not be modified or ducted.
6. Convection Heat Outlet Extension: This optional equipment is for homes with ceilings higher than 7' 6" such as cathedral type, and where the homeowner desires these openings to be higher than standard. CAUTION: If extensions are added, you must maintain a minimum clearance of 12" from the ceiling. The ceiling in the chase must be raised to maintain a minimum 12" from the ceiling outlet assemblies and the ceiling in the chase. 6" Extension Kit #2206 12" Extension Kit #2212 18" Extension Kit #2218. When extensions are used, damper blades must be adjusted. See Page 9, Step 15, Tuning Convection Outlet Damper Blades.
7. Fireplace Chase: This is the framed enclosure where the CENTURY sits. The house air enters around framing spacers and returns to the room through the chase heat grill. This fireplace chase must be sheet rocked with fire-rated sheetrock, including ceiling. The front wall is not sheet rocked on the inside.
8. Fire stop: The fire stop is installed in the sheet rocked ceiling in the fireplace chase. A fire stop must also be installed at each floor or ceiling the flue goes through. Extra fire stops may be purchased from your CENTURY dealer. #10TGSA
9. Framing Spacer: These are metal spacers attached to the CENTURY around the door area, convection heat outlet assemblies, and various positions on the back and sides of the unit. These spacers are designed to maintain 2" clearance to back and sides of the unit, and 3/4" air gap for air to enter around the door and convection heat outlets. **DO NOT REMOVE OR ALTER SPACERS OR CLOSE IN AIR GAPS.**

10. 180 Degree Elbow with Anti-Siphon Valve: This optional duct fitting is used anytime you are required to go overhead with the duct system. This duct fitting is equipped with an air pressure operated anti-siphon valve that closes when the blower is in operation. This forces the air through the duct system. The anti-siphon valve opens when the blower is not in operation; eliminating the possibility of super heated air siphoning into the duct system, instead of being emitted from the convection heat outlets located on top of the CENTURY. You must use this 180 degree elbow with the anti-siphon valve when going overhead. Kit #2220 Drawing U-2 is an example of the use of this 180 degree elbow.

11. 90 Degree Elbow: The optional 90 degree elbow may be attached directly to the CENTURY unit, or to any other optional CENTURY duct parts except the transition. Kit #2202 Drawing T-2 is an example of the use of this 90 degree elbow.

12. Transition: This is an optional duct fitting that turns the air from one direction to another with a minimum of static air pressure increase. The air enters the CENTURY from the bottom on one side and exits from the bottom of the other side. The transitions are normally used when the ducts are required to drop below the floor or when using the 180 degree elbow for going overhead. See Drawings U-2 and S-1 for examples. Kit #2220

13. Non combustible materials are those which will not ignite or burn. Such materials are those consisting entirely of steel, iron, brick, tile, concrete, slate, glass or plasters, or a combination thereof, or those having a UL Fire Rating of Zero (0).

Combustible materials are those materials made of or surfaced with wood, compressed paper, plant fibers, plastics, or any material capable of igniting and burning, whether flame proofed or not, plastered or un-plastered.

CAUTION - DANGER: NEVER FIRE THE CENTURY IF THE BY-PASS VALVE IS IN THE CLOSED (AIR CONDITIONING) POSITION. AIR MUST BE AVAILABLE FROM THE DUCT SYSTEM TO AVOID OVERHEATING, WHICH COULD CREATE A FIRE HAZARD.

IF ELECTRIC OPERATED DAMPERS ARE USED, DAMPERS SHOULD BE CLOSED ONLY WHEN IN AIR CONDITIONING MODE. IF POWER OUTAGE OCCURS, THE NORMAL POSITION OF THE DAMPER WOULD BE OPEN TO ALLOW INCOMING AIR FROM THE DUCT SYSTEM.

HOW TO BUILD A FIRE IN YOUR CENTURY FIREPLACE FURNACE

1. Open glass doors and the main damper (full open) with combustion air dampers open. Combustion air control is at the bottom of door, right side. Pull out to open.
2. Place two small logs (approximately 3" in diameter, 16" long) parallel to sides of unit approximately 1 foot apart. Fill space between logs with paper, top paper with kindling. This aids in burning. Ignite the paper and shut the glass doors. Add larger sticks of wood (4" in diameter) across the original logs to maintain fire. Unit may smoke out the front doors until it is heated to operating temperatures. Keep doors closed until unit is heated up.
3. Continue to burn to heat firebox and to obtain approximately 3" bed of coals. Let fire burn down and spread coals to sides and back of the firebox.
4. Add large logs - we recommend not splitting logs under 10". Allow wood to catch fire, then close main damper to next to last position or fully closed for proper heat. CAUTION: Use log retainer furnished with unit. **Do NOT use other grate.**
5. Adjust combustion air dampers toward the closed position. The proper adjustment of the main damper and the combustion air may require some practice. The main damper should be run nearly closed except when flash firing the unit.
6. If the glass doors are opened for any purpose, such as adding wood, the main damper must be opened prior to opening glass doors to prevent smoking out the front of the unit.
7. When loading the fireplace, put in a full load of wood, not just one or two sticks. To control the burn, adjust the combustion air damper and main damper.
8. Unit may be used like a conventional fireplace with doors open after unit is warmed to normal operating temperatures. Maintain a good fire.

ADDITIONAL TIPS ON USE OF UNIT

1. For maximum efficiency, the unit should be operated at all times with glass doors closed. Combustion air damper should be towards closed position to attain desired heat output.
2. The firebox contains a firebrick floor; you should not use a grate with your CENTURY unit. Research shows that building your fire on hot coals actually extends the burn time and efficiency. Ash continues to burn long after initial burn appears completed. This method aids in complete burning of the wood. Coals should be stirred periodically, before reloading, with fireplace tools to burn all residue possible. Remove dead ash to the ash box.
3. Proper care and "burn-in" of your firebox will prolong the period of enjoyment with little maintenance. For the first fire, build a small fire and then increase to a normal fire.
4. A proper amount of combustion air is important for your fireplace. Regulation of the oxygen supply directly controls heat output from the CENTURY unit. Reducing the oxygen will reduce the fire, therefore reducing the heat and prolonging the duration of wood burn. Close down the air intake after the unit has been heated, allowing only the amount of oxygen required to maintain fire adequate to heat your home.
5. Due to the fact that the metal parts of your CENTURY are either painted or have an oil coating, it is common for the unit to emit smoke and paint odors from the ducts until this material has been burned off. It is recommended that the unit be fired prior to finishing the home. Normally 8 to 12 hours burning

Eliminates this odor and smoke emission.

6. Wood burning created creosote build-up in the flue chambers and in the chimney. It is imperative that a flash fire be built on a daily basis to keep the flue chamber and chimney free of this build-up. If the unit is not flashed on a regular basis, large build-ups of creosote can result in dangerous flue fires. Flash fire should be burned while the unit is hot.

- A. Open combustion air full open.
- B. Load fire box approximately 1/3 full of dry kindling material.
- C. Close doors.
- D. Do not close main damper.

7. Check chimney at least monthly for creosote build-up. Creosote usually starts building in the cap and works its way down the chimney.

8. When burning the CENTURY, you should see very little if any smoke emitted from the flue. If excess smoke is emitted from the flue, you have not established an adequate coal bed. Open the air control and damper until coal bed is established. Smoking will occur until bark is burned off the wood. This usually takes not more than an hour after loading. Smoke indicates unburned fuel.

CENTURY FIREPLACE-FURNACE

OWNERS MANUAL SUPPLEMENTAL INSTRUCTIONS

THIS SUPPLEMENT IS INTENDED TO ADD TO THE OWNER'S MANUAL AND SHOULD BE READ IN CONJUNCTION WITH THE FULL OWNER'S MANUAL.

1. DESCRIPTION AND COMPLIANCE STATUS

- 1.1 This Supplement applies to all CENTURY models unless otherwise indicated.
- 1.2 CENTURY FIREPLACE-FURNACES are exempt from the U. S. Environmental Protection Agency's Standards set forth in 40 CFR Part 60. Testing to verify exemption was conducted by Intertec Testing Services, Warnock Hersey International, Inc. Middleton, WI, an EPA certified testing laboratory, under test method 28A.
- 1.3 Under specific test conditions, the CENTURY CO-36 GW has been shown to deliver heat at ranges up to 167,229 BTU per hour.

2. TAMPER WARNING

- 2.1 Tampering with or modification of CENTURY FIREPLACE-FURNACES will void the CENTURY warranty and under some circumstances may constitute a violation of Federal Law.

3. FUEL SELECTION

- 3.1 CENTURY FIREPLACE-FURNACES are designed to burn natural wood only. Higher efficiencies and lower emissions generally result when burning air dried seasoned hardwoods, as compared to soft woods or to green or freshly cut hardwoods. Un-split wood will give a longer Wood burn and split wood will produce a prettier fire. For heating, use un-split wood of 8" to 12" Diameter for maximum potential; for viewing, add split wood for beauty.
- 3.2 CENTURY may use a 90,000 BTU gas log system, available from your CENTURY dealer.

DO NOT BURN IN YOUR CENTURY

HEDGE or other woods with unusually high heat unless your unit has been specifically manufactured for hedge or other high heat woods. Contact the factory for details.

TREATED WOODSCOALOIL OR GASOLINEGARBAGECARDBOARDSOLVENTSCOLORED PAPERS (including newsprint)

TRASH

Burning treated wood, garbage, solvents, colored paper or trash may result in release of toxic fumes and may poison.

Burning coal, cardboard or loose paper can produce soot, or large flakes of char or fly ash.

SPARK PROTECTION

Always use a spark screen or other protection against sparks when burning with doors open in fireplace mode.

4. OPERATION AND MAINTENANCE

4.1 Building and Maintaining a Fire. See regular manual for full details. Be sure to open damper before opening doors to avoid smoke spillage into the room. Also, note that a flue must be heated to assure good draft, so leave doors slightly ajar when first starting your fire to allow the flue to heat. Then close doors and damper down for furnace mode or open doors and damper for fireplace mode operation.

4.2 Air Controls

4.2.1 Outside Combustion Air: Any blockage of outside combustion air will seriously affect burning. Be sure outside air intake is above any snow accumulation levels, is away from brush and is hooded to prevent animal nests. Check for clear air passage before burning, season and once a week when burning. Adequate outside combustion air is essential to proper operation and combustion.

4.2.2 Damper Setting: Damper control is located in the center above the doors approximately 24" above doors and has an oblong handle with the CENTURY logo and trade name. Grasp firmly and pull, then turn handle to the right (clockwise) to close damper and left

4.2.3 Combustion Air Control: At the bottom right (facing unit) of the door is a wood knob on a control rod. Push in to close, pull to open. When starting a fire, or for high burn, pull out. For lowest burn in furnace mode, push in fully. Settings in between vary combustion air.

4.2.4 Heat Levels: Your CENTURY heat output will depend on (a) an adequate coal bed of 3" to 5" having been created, (b) damper setting, (c) combustion air setting, (d) fuel loading, and type of fuel. After just a few burnings, you will learn the correct methods. Note that large round (un-split) wood has a longer burn rate.

4.3 Ash Removal and Disposal: Whenever dead ashes get 3" to 4" deep in your firebox and when the fire has burned down and cooled, remove excess ash to your ash box under the CENTURY. Clean out the ash box as needed. Rake live coals to one side, then remove to the ash box. Rake coals to the other side and clean out the rest of the dead ash. Then spread coals evenly over the firebox bottom to help maintain a hot charcoal bed. Ashes removed from the CENTURY should be placed in a metal container with a tight fitting lid. The closed container of ashes should be placed on a non-combustible floor or on the ground, away from all combustible materials, pending final disposal. The ashes should be retained in the closed container until all cinders have thoroughly cooled.

4.4 Door Gasket Replacement: Replacement gaskets and instructions on replacement are

available from Century.

WARNING ON OVER-BURNING

- 4.5 Attempts to achieve heat output rates that exceed design specifications can result in permanent damage to your CENTURY.

5. PROPER DRAFT

- 5.1 "Draft" is the force which moves air from the CENTURY up through the chimney. The Amount of draft in your chimney depends on the length of the chimney, local geography, Nearby obstructions and other factors. Too much draft may cause excessive temperature and inadequate draft may cause back-puffing into the room and plugging of the chimney.
- 5.2 Conditions indicating inadequate draft: Inadequate draft will cause the appliance to Leak smoke into the room through the appliance and chimney connector joints.
- 5.3 Conditions indicating excessive draft: An uncontrollable burn or a glowing red metal part Or chimney connector may indicate excessive draft.

6. START-UP CAUTION

- 6.1 CAUTION: Never use gasoline, gasoline-type lantern fuel, or similar liquids to start or freshen up a fire in this fireplace. Keep all such liquids well away from the fireplace while it is in use.

VOLUNTARY COMPLIANCE WITH EPA REQUIRED MANUAL PROVISIONS

CENTURY is not required to provide this supplement as it is exempt under 40 CFR Part 60. Nevertheless, in order to contribute to fireplace education, it is voluntarily doing so, reserving its right, however, to discontinue or modify its compliance as it deems warranted.

QUESTIONS OR PROBLEMS?

Call toll free 1-800-284-4328 weekdays, Central Time from 9:00 AM to noon, and from 1:00 PM to 4:00 PM with any questions of problem with your CENTURY installation, operation, or maintenance. We want you happy and safe with your CENTURY!

CENTURY MANUFACTURING, INC.
1608 E. 20TH
JOPLIN, MO 64804
417-624-1480

CENTURY SIGN-OFF FOR INSTALLING TRADES

I have read the installation manual for the Century fireplace furnace and installed the unit per the installation instructions.

Model Number _____

Serial Number _____

Date Purchased _____

Manual revision date _____

	Installing Trade	Date Completed
Century Set-up	_____	_____
Flue Package	_____	_____
Electrical	_____	_____
Ducting	_____	_____
Framing	_____	_____
Interior Chase	_____	_____
Exterior Finish	_____	_____
Interior Finish	_____	_____

Signed copy of Sign -Off Sheet must be returned with your warranty card.