



S O A P S T O N E



Phoenix

Model (8612)

Woodstove

OWNER'S MANUAL INSTALLATION AND OPERATING INSTRUCTIONS



We recommend that our products be installed and serviced by professionals who are certified in the U.S. by NFI (National Fireplace Institute).

www.nficertified.org

PLEASE READ THIS ENTIRE OWNER'S MANUAL BEFORE YOU INSTALL, AND USE, YOUR NEW PHOENIX WOOD STOVE. To reduce the risk of fire, follow the installation instructions. Failure to follow these instructions may result in property damage, bodily injury, or even death.

SAVE THESE INSTRUCTIONS FOR FUTURE REFERENCE!

CONTACT LOCAL AUTHORITIES HAVING JURISDICTION (BUILDING DEPARTMENT or FIRE OFFICIALS) ABOUT PERMITS REQUIRED, RESTRICTIONS AND INSTALLATION INSPECTION IN YOUR AREA.

Warnock Hersey



Intentionally Blank

Table of Contents

INTRODUCTION	4
CODES	5
SAFETY INFORMATION	5
PERIODIC CHECKLIST	5
EMERGENCY PROCEDURES	6
HEARTHSTONE'S THERMO-CERAMIC BAFFLE SYSTEM	6
SPECIFICATIONS	7
INSTALLATION	8
UNPACKING	8
INSTALLING YOUR STOVE	8
HEARTH REQUIREMENTS AND FLOOR PROTECTION	8
OUTSIDE AIR SUPPLY	9
CLEARANCES TO COMBUSTIBLES	10
VENTING COMPONENTS AND CONFIGURATION	14
CONNECTING YOUR WOOD STOVE	15
INSTALLATION IN A MOBILE HOME	18
OPERATION	19
CONTROLS AND FEATURES	19
CHOOSING FIREWOOD	19
BUILDING A FIRE	20
BREAKING IN YOUR WOOD STOVE	20
BUILDING A BREAK IN FIRE	20
NORMAL OPERATION	21
BUILDING A FIRE FOR EVERYDAY USE	21
BURN RATE	21
OVER-FIRE CAUTION	22
REMOVAL AND DISPOSAL OF ASHES	22
MAINTENANCE	22
TROUBLESHOOTING	25
REPLACEMENT PARTS & OPTIONAL ACCESSORIES	27
SAFETY LABEL	28
LIMITED WARRANTIES	29

Introduction

Congratulations! You have just invested in a most unique wood burning stove – the Phoenix Wood Burning Stove from Hearthstone Quality Home Heating Products Inc®. The Phoenix Model 8612 is a clean burning EPA certified, non-catalytic wood-burning stove. With a 2.30 cubic foot firebox capacity, and only 2.4 grams per hour particulates emission, you can be proud to join the Hearthstone family with our Phoenix Cast & Stone Wood Burning Stove. The generous depth of the firebox, and large door, allows for loading wood up to 21 inches long!

Your purchase ensures you many years of clean, comfortable heat with minimal maintenance. You receive the benefits of the most advanced technology in wood burning without the cost and maintenance requirements of a catalytic stove. The Phoenix blends modern technology with the unique beauty and heating qualities of soapstone, long known for its even heat transmission, and long heat-retaining ability. We trust that you will appreciate the quality of our handcrafted product.

Please read this manual in its entirety. Its purpose is to familiarize you with your stove's safe installation, proper break-in, operation, and maintenance. It contains information that is useful to you now, and for years to come, so keep it handy and refer to it as needed.

Use these instructions, as well as national, state, and local building codes to install your stove. Be sure to maintain the designated stovepipe and stove clearances to walls, ceilings, hearth, and other combustible surfaces. This will help reduce the risk of fire. Failure to follow these instructions can result in property damage, bodily injury, and even death.

Locate your stove in a safe, convenient, open area; away from traffic flow, doors, and hallways; and near a chimney and chimney connector. Review the proper clearance measurements from combustible surfaces. You can safely reduce required clearances in most cases with a special connector pipe and special wall coverings as specified by this manual, the NFPA 211 codes, and your local authorities having jurisdiction.

Keep furniture, drapes, curtains, wood, paper, and other combustibles far away from the stove. Never

install the stove in a location where gasoline, kerosene, charcoal lighter fluid or other flammable liquids are used, or stored.

Locate the stove centrally in your living area if possible to allow the heat to travel naturally to distant rooms. We recommend that you do not locate your stove in an uninsulated basement. The amount of radiant energy required to heat concrete basement walls is so great that most of the usable heat is absorbed by them, and lost to the home.

 **SAFETY NOTICE: A HOUSE FIRE MAY RESULT IF THIS STOVE IS NOT INSTALLED PROPERLY. FOR YOUR SAFETY, CAREFULLY FOLLOW THE INSTALLATION DIRECTIONS. CONTACT LOCAL BUILDING, OR FIRE OFFICIALS, ABOUT RESTRICTIONS AND INSTALLATION INSPECTION IN YOUR AREA.**

The performance of your stove depends on many variables. Since all installations are unique, the general information and operating procedures presented here can only serve as useful guidelines rather than hard and fast rules. Should you have any questions, do not hesitate to contact your dealer for additional information.

This stove is manufactured and warranted by:

**Hearthstone Quality Home Heating
Products, Inc®**

317 Stafford Ave.
Morrisville, VT. 05661

CODES

When installing your Phoenix wood stove, it is imperative that you adhere to all local codes, which can be obtained from either of the following two National sources:

American National Standards Institute, Inc. (ANSI)
1430 Broadway
New York, NY 10018

National Fire Protection Association, Inc. (NFPA)
Battery March Park
Quincy, MA 02269

If you are installing your Phoenix in a mobile home, follow the guidelines described in the Manufactured Home Construction and Safety Standard, Title 24 CFR, Part 3280 (United States).

SAFETY INFORMATION

Read and understand this Owner's Manual thoroughly before installing and using this stove.

Make sure to install your stove:

- ❑ According to the manufacturer's recommendations
- ❑ In accordance with all applicable codes
- ❑ With the proper sized chimney

When using your stove:

- ❑ Warn children and others unfamiliar with woodstoves of the danger of touching hot, radiating surfaces of your stove. For your additional safety, obtain hearth, and stove guards through your local dealer.
- ❑ Follow recommended break-in procedure as outlined in this manual.
- ❑ Burn natural wood only. Higher efficiencies and lower emissions result when burning air-dried, seasoned wood, as compared to green or freshly cut wood.
- ❑ Use caution when loading firewood into a hot stove.
- ❑ Keep the front door tightly closed at all times except when loading wood.
- ❑ Keep the ash pan tray fully inserted and the ash door closed tightly.
- ❑ Inspect the stovepipe, chimney connector, and chimney as recommended.
- ❑ Be sure the removable ash lip is in place while using the stove. If the ash lip is not installed properly, the hearth surface may exceed safe temperatures.

Follow these safety precautions:

- ❑ **Never** modify this stove in any way, especially the primary air control system.
- ❑ **Never** burn kiln dried wood, painted or treated wood, solvents, trash, plywood, colored or glossy paper, artificial logs, cardboard, coal, garbage, or driftwood. *Especially, do not burn coal in this stove.*
- ❑ **Never** use gasoline, kerosene, charcoal lighter fluid, or any other liquid fuels as fire starters. Do not use solid fire starters, to start or invigorate the fire. These fuels can possibly generate carbon monoxide, which can sap the supply of oxygen in your home. Keep all such materials away from the stove.
- ❑ **Never** use the stove if the ash pan door is open, damaged, not in place, or not sealing.
- ❑ **Never** use a wood grate or other device to elevate the fire.
- ❑ **Do not** allow logs to rest against or otherwise touch the glass when the door is closed.
- ❑ **Do Not** slam the door, or use the door to force wood in to the stove.
- ❑ **Never** over-fire your stove. (See page 22)
- ❑ **Never** put articles of clothing, or candles, on a hot stove.
- ❑ **Do Not** connect the stove to a flue that serves another appliance.

Other safety guidelines

- ❑ Keep all combustible items such as furniture, drapes, clothing, and other items, at least 36" (0.92 m) from the stove (See page 10)
- ❑ Install a good smoke detector, preferably in an area away from your wood stove.
- ❑ Keep a fire extinguisher handy. We recommend the type rated "A B C."
- ❑ Dispose of ashes properly. (See page 22)
- ❑ Keep children and pets away from the stove; they could be burned by touching a hot stove.
- ❑ Clean your chimney system as needed. (See page 22)

PERIODIC CHECKLIST

Perform each of these tasks at the specified intervals.

At the End of Every Week:

- Empty ashes from the firebox and ash pan, sooner if the firebox or the ash pan begins to fill up. A good indicator is when ashes reach the openings in the "dog house", or lower primary air inlet.

At the Beginning of Every Other Month:

- A visual inspection of the chimney connector and chimney for creosote is recommended depending upon your use of the stove. (Please see page 23 - Creosote Formation and Need For Removal)
- Check door seals using the "dollar bill test." - When the fire is out and the stove is cool, shut the door on a dollar bill. If the bill pulls out without any resistance, then your stove's door isn't sealed properly. To tighten the seal, change the door gasket (Refer to page 23 – Gaskets). Check hinge screws for tightness.

At the End of Every Season:

- Dismantle the chimney connector and clean it thoroughly. Replace any pieces that show signs of rust or deterioration.
- Inspect and, if necessary, clean your chimney.
- Thoroughly clean the inside of the stove.
- Inspect all door gasket material and replace if worn, frayed, cracked or extremely hard.

EMERGENCY PROCEDURES

If you have a stovepipe or chimney fire, follow these instructions:

1. If the fire is too threatening, leave the area and call the fire department immediately! If not, perform the next three steps.
2. Close the primary air control.
3. Close the stovepipe damper (if present).
4. Keep the stove front, and ash doors closed!

 **WARNING: DO NOT ATTEMPT TO PUT OUT A STOVEPIPE OR CHIMNEY FIRE BY THROWING WATER ONTO THE STOVE, STOVEPIPE, OR CHIMNEY. THE EXTREMELY HIGH TEMPERATURE ASSOCIATED WITH SUCH FIRES CAN CAUSE INSTANTANEOUS STEAM AND SERIOUS BODILY HARM.**

Once the chimney fire has expired, leave the primary air control closed and let the fire in the stove die out completely. The stove should not be fired again until the stove, stovepipe, and chimney are all thoroughly inspected for any sign of damage. You must correct any damage before using your stove again.

HEARTHSTONE'S THERMO-CERAMIC BAFFLE SYSTEM

To enhance the combustion efficiency and reduce the emissions of the fire in your stove, Hearthstone has developed an advanced THERMO-CERAMIC baffle system. This system uses a lightweight, durable ceramic material above the burner tubes to maintain the high temperatures in the secondary combustion area and maintain the low emission – high efficiency combustion you desire. This new technology will not corrode, rust dissolve or lose its strength, however it is vulnerable to puncture or cracking due to rough handling.

 **PLEASE EXERCISE CARE WHEN LOADING WOOD OR CLEANING YOUR STOVE, NOT TO DAMAGE THE Thermo-Ceramic BAFFLE**

Located directly above the burner tubes in the firebox, this white sheet of material will break if wood or cleaning brushes impact it. Be careful when loading and cleaning your stove to not break this material. If this piece has been fractured or a hole is punctured, it will cause the stove to function improperly. You must replace the board through a qualified Hearthstone dealer.

SPECIFICATIONS

Maximum Heat Output: 55,000 BTUs/hour (cordwood)
35,000 BTUs/hour (EPA Method)

Size Of Heated Area: 1,500 to 2,000 square feet.

Firebox Capacity: 2.30 cubic feet (0.227 cubic meters) or 40 pounds of wood (The amount and weight of wood contained per cubic foot of firebox volume can vary from 15 to 36 lbs. per cubic foot depending on type of wood, moisture content, packing density and other factors. As a constant for comparison and test purposes, we are assuming 20 lbs. of seasoned hardwood per cubic foot of firebox volume).

Maximum Log Length: 21" (53cm)

Height: 27-1/2" (70 cm)

Width: 28" (71 cm)

Depth: 20" (51 cm)

Front Door Size: 16-3/4" wide x 10-5/8" high (43 x 27 cm)

Stovepipe Size: 6" (152 mm) diameter

Metal Chimney: 6" (152 mm) inside diameter

Masonry Chimney: 6" (15.2cm) inside diameter (round flue), 8" x 8" (20 x 20cm) (square flue)

Flue Exit: 45° exit

Actual Weight: 400 pounds (181 kg)

Crate Dimensions: H-34" (86cm) W-32" (81 cm) L-29" (74 cm)

Optional Equipment: - Rear Heat Shield
- Outside Air Kit

Soapstone Finish¹: Polished Gray Soapstone

Castings Finish: Painted Matte; and Porcelain Enamel in various colors.

¹ Polished gray soapstone is a natural product and will vary from stone to stone. Various amounts of gray, charcoal, blue and green are usually evident, and vary according to the natural composition of the stone.

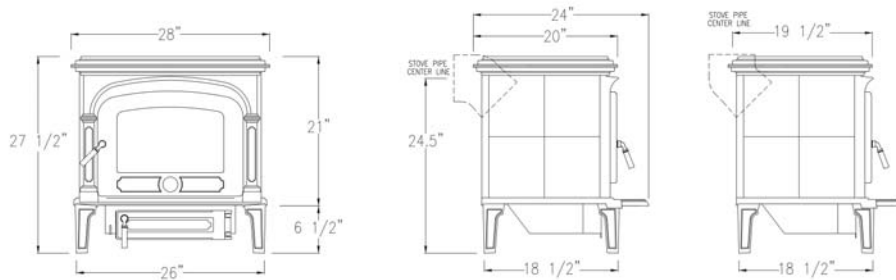

Installation

UNPACKING

Hearthstone packages your Phoenix stove with the greatest care, so that it ships safely. Under certain circumstances, however, damage can occur during transit and handling. When you receive your stove, unpack it carefully, inspecting your stove and all parts for damage. Also, make sure that all parts are included with the stove, on the stove, or in the firebox. If any parts are damaged or missing, please contact your dealer immediately.

INSTALLING YOUR STOVE

First, you must decide where to situate your stove. After choosing an appropriate spot, inspect this location to make sure that the stove will have enough clearance to combustible materials that would surround the stove. These combustibles can include walls, floor, ceiling, fireplace, and chimney. You must carefully consider the clearances to all of these combustibles before actually connecting your stove. When considering these clearances, also decide the kind of floor the stove will rest on. Depending on your floor, you can install your stove as it is, or use a floor protector (Hearth).

You will need to purchase a reversible 45° elbow for the flue collar exit. By reversing the 45° elbow, the stove can be installed as either a *rear exit stove* (stovepipe typically exiting horizontally from the back of the stove into a chimney) or a *top exit stove* (stovepipe typically exiting vertically up from the stove into a close clearance chimney through the ceiling and up above the roofline). These and other methods of installation are acceptable as long as all clearances, codes and other installation instructions are observed.

Use this section to plan how to situate your stove in your particular location. Consider both the clearances of the stovepipe and the stove itself to the surrounding combustibles.

The soapstone walls of the Phoenix soapstone stove produce an even, radiant heat. Locate the stove centrally in your living area to allow the heat to travel naturally to distant rooms. It is not recommended that you locate your stove in an uninsulated basement. The amount of radiant energy required to heat concrete basement walls is so great that most of the usable heat is absorbed by them and lost to the rest of the home.

Read this chapter to obtain a sound understanding of how to properly install your stove.

If you use a close clearance connector pipe, it must be listed, and tested to UL standards. Check the listing of your pipe for actual clearances. The diagrams in this manual represent typical installations, but are specific to the Simpson Dura-Vent DVL brand. Clearances cannot be reduced without the use of close clearance connector pipe and/or by protecting the surfaces per NFPA 211 standards.

HEARTH REQUIREMENTS AND FLOOR PROTECTION

The floor protection must extend beyond the body of the stove at the minimum as follows:

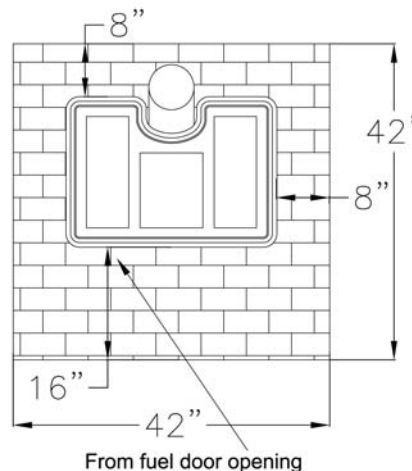

Installations in Canada require 18" (45.72 cm) of floor protection in the front.

Rear clearance is required only if stovepipe runs horizontally back from the top of the stove. An acceptable floor protector is a 3/8" (10 mm) minimum thickness non-combustible or listed floor protector with an "R" factor of 1.0.

The floor protector must have minimum dimensions of 42" w x 42" d (1067 mm x 1067 mm) and must extend at least 8" beyond the body of the stove on the sides.

OUTSIDE AIR SUPPLY

You can connect an outside air source directly to this stove using an optional outside air kit. The advantage of providing outside air directly to the stove is that the air used by the stove for combustion is taken from outside the residence rather than from within the room where the stove is located. With outside air supplied directly to the stove, drafts within the room and air infiltration within the building are reduced. Use of the outside air kit may also improve stove performance in a particularly airtight house, or when several other air-exhausting appliances are present.

The outside air kit for this stove allows for the direct connection of the stove's air intake to a minimum 3" (76 mm) diameter duct (supplied by others) which leads to the outside of the house. When

considering placement of the duct from the outside of the house to the hearth, keep in mind the need to avoid structural members of the house. The outside air kit will attach to the bottom of the stove. Before installing the kit, determine where the duct for the outside air will terminate. The duct can terminate from the back center of the ash dump box or the center of the right side of the ash dump box by changing the position of the screw-on plates and the adaptor.

Ensure the termination of the duct on the outside wall of the structure is located in such a manner to prevent the possibility of obstruction by snow, leaves or other material. Screen the duct opening against animals and insects. The termination should be screened using ¼" x ¼" mesh metal screen and be covered with a rain/wind proof hood (flex pipe, outside termination, mesh, and hood supplied by others. Contact your dealer for availability).

CLEARANCES TO COMBUSTIBLES

Using Single Wall Stove Pipe without Rear Heat Shield

- Residential and Mobile Home installations for USA/Canada – Top Exit - maintain 18" minimum clearance between horizontal chimney connector and ceiling.

Parallel Installation:

- A: Side walls to stove: 20" (51 cm)
- B: Back wall to stove: 25" (64 cm)
- C: Back wall to pipe: 21" (53 cm)

Corner Installation:

- A: Wall to stove corner: 18" (46 cm)
- B: Wall to pipe: 25" (64 cm)

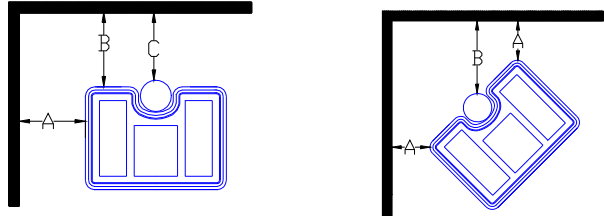

Using Close Clearance Connector Pipe without Rear Heat Shield

- Residential and Mobile Home Installations for USA/Canada – Top Exit

Parallel Installation:

- A: Side walls to stove: 20" (51 cm)
- B: Back wall to stove: 25" (64 cm)
- C: Back wall to pipe: 21" (54 cm)

Corner Installation:

- A: Wall to stove corner: 18" (46 cm)
- B: Wall to pipe: 21" (54 cm)

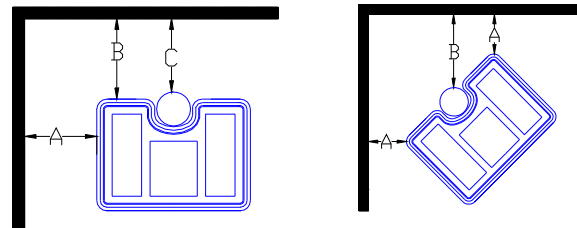

Using Close Clearance Connector Pipe with Rear Heat Shield

- Residential and Mobile Home Installations for USA/Canada – Top Exit

Parallel Installation:

- A: Side walls to stove: 16" (41 cm)
- B: Back wall to stove: 13" (33 cm)
- C: Back wall to pipe: 9" (23 cm)

Corner Installation:

- A: Wall to stove corner: 12" (31 cm)
- B: Wall to pipe: 18" (46 cm)

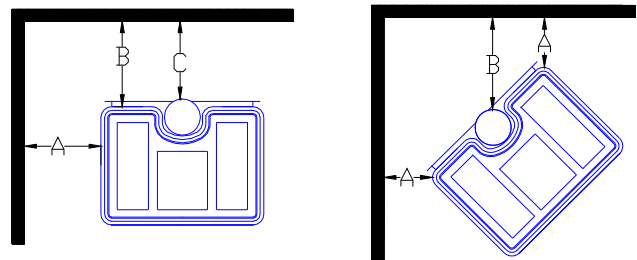

Using Close Clearance Stove Pipe With Rear Heat Shield and NFPA 211 Protected Surface *

- Residential and Mobile Home Installations for USA/Canada – Top Exit

Parallel Installation:

- A: Side walls to stove: 8" (20 cm)
- B: Back wall to stove: 9" (23 cm)
- C: Back wall to pipe: 5" (13 cm)

Corner Installation:

- A: Wall to stove corner: 5" (13 cm)
- B: Wall to pipe: 11" (28 cm)

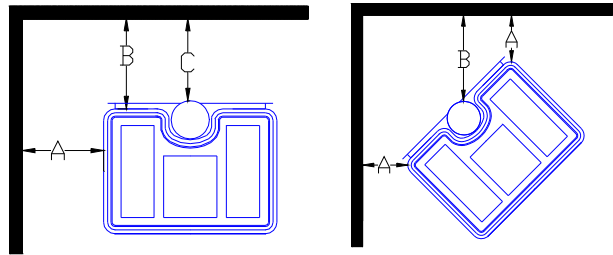

Note: The stove must be bolted to the floor when installing it into a mobile home.

* The National Fire Protection Agency has recommended minimum clearances to non-combustible surfaces. Following are two examples of NFPA 211 non-combustible walls. To make a wall non-combustible, protect it with a minimum of 24 gauge sheet metal or a minimum of 4" (102 mm) of masonry, both with a 1" (25mm) air space between the wall and the masonry or sheet metal. Refer to NFPA 211 for a complete list of non-combustible wall configurations.

Using Single Wall Stove Pipe without Heat Shield

- Residential and Mobile Home Installations for USA/Canada – **Rear Exit**
- Maintain 18" min. clearance between horizontal chimney connector and ceiling.

Parallel Installation:

- A: Side walls to stove: 20" (51 cm)
- B: Back wall to stove: 25" (64 cm)

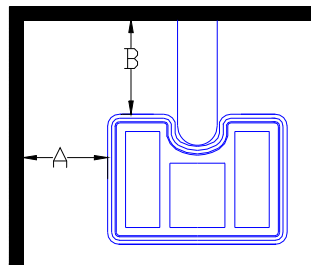

Using Close Clearance Connector Pipe with Heat Shield

Residential and Mobile Home Installations for USA/Canada – Rear Exit

Parallel Installation:

- A: Side walls to stove: 16" (41 cm)
- B: Back wall to stove: 13" (33 cm)

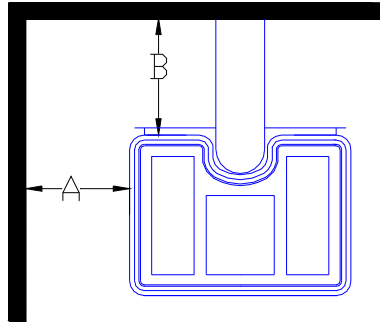

Alcove Installation Using Close Clearance Connector Pipe and Rear Heat Shield

- Residential and Mobile Home Installations for USA/Canada

- A: Side walls to stove: 16" (41 cm)
- B: Back wall to stove: 13" (33 cm)
- C: Back wall to pipe: 6" (15 cm)
- D: Top of stove to ceiling: 40" (102 cm)

The minimum alcove size:

- Height: 68" (173 cm)
- Width: 60" (152 cm)
- Max. Depth: 48" (122 cm)

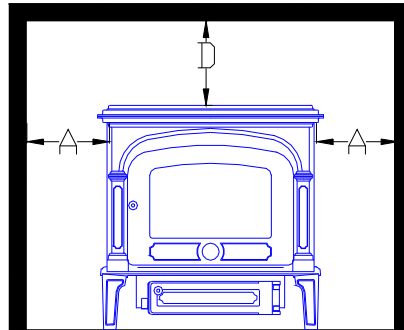

Alcove Installation Using Close Clearance Connector Pipe and Rear Heat Shield with NFPA 211 Protection.

- Residential and Mobile Home Installations for USA/Canada

- A: Side walls to stove: 8" (20 cm)
- B: Back wall to stove: 9" (23 cm)
- C: Back wall to pipe: 5" (13 cm)
- D: Top of stove to ceiling: 36" (91 cm)

The minimum alcove size:

- Height: 64" (163 cm)
- Width: 40" (102 cm)
- Max. Depth: 48" (122 cm)

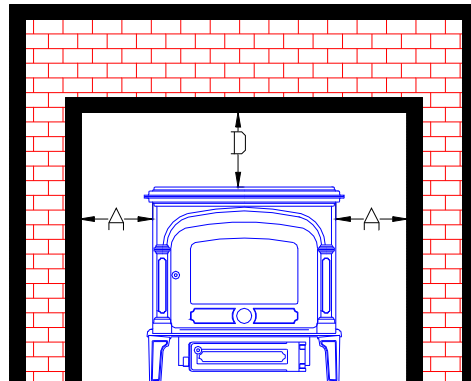

Clearances For Masonry Fireplace Installations

- INSTALLATION INTO A MASONRY FIREPLACE BUILT TO UBC CHAPTER 37.
- Do not remove brick from the fireplace to accommodate the stove. Connect the flue outlet directly to the chimney flue. The chimney flue must have a minimum inside diameter of 6" (152 mm) or a maximum measurement of 8" x 8" (203 mm x 203 mm) square. If the chimney flue is larger than 8" x 8", reline it to meet the required flue size.

- A: Side wall to stove: 20" (51 cm)
 B: Side trim to stove: 15" (38 cm)
 C: Top trim to stove: 22" (56 cm)
 D: Mantel to stove: 27" (69 cm)

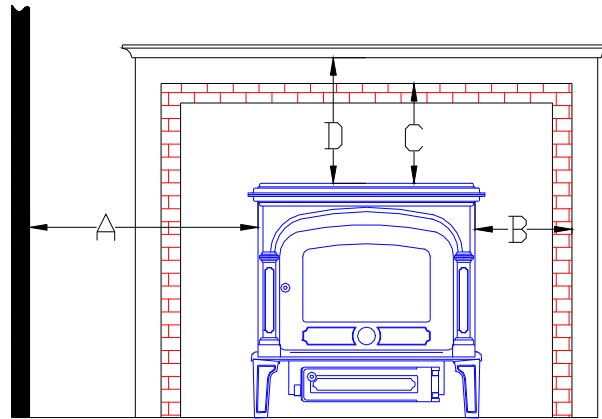

Chimney Connector (Stovepipe) Clearances

The National Fire Protection Agency provides recommended minimum clearances for chimney connectors to combustibles such as walls, ceilings and floors. Once the stove is installed at safe distances from combustible surfaces, it is also important to maintain proper connector clearances for the remainder of the installation. For example, horizontal runs of stovepipe must maintain NFPA recommended clearances from the ceiling. However, other minimum recommendations are exceeded when following the required clearances for the stove to combustible materials, because our stove combustibles clearances take precedence over connector clearances.

For walls and ceilings, the NFPA recommendation for single wall pipe is 18" (457 mm) and for close clearance pipe, it is 5" (127 mm). For flooring, the floor protector's minimum area must be under the chimney connector and 2" (50 mm) beyond each side.

1. 24 gauge, single wall pipe to wall = 18" (457 mm).
2. Close clearance pipe to wall = 5" (127 mm).

VENTING COMPONENTS AND CONFIGURATION

Carbon Monoxide Poisoning: There is a possibility of generating carbon monoxide (CO) with most fuels, including to a minimal extent, wood. A properly maintained and operated woodstove and venting will eliminate the chance of this occurring. Early signs of carbon monoxide poisoning resemble the flu with headaches, dizziness, and/or nausea. If your home fills with smoke, or if you have the listed symptoms, evacuate everyone to fresh air immediately! As a safety precaution, install a CO monitor in, or near, each room wherever any fuel burning heating unit or appliance operates.

DO NOT CONNECT THIS UNIT TO A CHIMNEY FLUE SERVING ANOTHER APPLIANCE!

- Single wall connector is 24 MSG or 25 MSG blued steel stovepipe.
- Double wall connector (close clearance pipe) which must be used with a listed factory-built "Type HT" chimney, also may be used with a masonry chimney to reduce clearances, is available from several manufacturers, your dealer can help you choose. Some air insulated connector pipe models available are Simpson Dura Vent DVL, and Metalbestos DS. Security, GSW and Ameritec also have acceptable close clearance connector pipe.
- When used in a mobile home, a spark arrestor is required. (See page 18)
- Chimney connector will not pass through floor or ceiling, nor any attic or roof space, closet or similar concealed space. Where passage through a wall or partition of combustible construction is desired, the installation shall conform to NFPA 211 or CAN/CSA - B365.
- It is very important to follow minimum clearances for chimney connectors to combustibles such as walls and ceilings when installing the stove near non-combustible surfaces. Typical chimney connector clearances are outlined beginning on page 9. The single wall clearances are generic; the Double wall clearances are for Simpson Dura Vent DVL.
- **Check The Specifications From The Manufacturer Of Your Connector.**

Components of a Venting System

The complete venting system consists of two components, the *chimney connector* and a *chimney*. Both these components become extremely hot during use. Temperatures inside the chimney may exceed 2,000 F (1093 degrees C) in the event of a creosote fire.

To protect against the possibility of a house fire, the chimney and stovepipe must be properly installed and maintained. Ensure the venting system is consistently in good condition. Replace rusted, cracked, or broken components.

A thimble is required when a connection is made through a combustible wall to the chimney. A wall pass-through, or chimney support package, is used when a connection is made through a wall or ceiling to a prefabricated chimney. These accessories are absolutely necessary to provide safe clearances to combustible wall and ceiling material.

This stove can be connected to a lined masonry chimney or an approved high temperature prefabricated, residential type building heating appliance chimney. **DO NOT** connect this stove to a chimney serving another appliance, as doing so will affect the safe operation of both appliances.

Chimney Connector

NOTE: The chimney connector cannot pass through an attic, roof space, closet or similar concealed space, or a floor or ceiling. Where passage through a wall or partition of combustible construction is desired, the installation shall conform to NFPA 211 or CAN/CSA-B365.

Use only 6" (152 mm) diameter, 24-gauge stovepipe for the chimney connector. **Do not use aluminum, or galvanized steel pipe**, as they cannot properly withstand the extreme temperatures of a wood fire.

Do not use stovepipe as a chimney. You must connect your stove to a chimney comparable to those recommended in this manual. Stovepipe (the chimney connector) is used only to connect the stove to a proper chimney.

 **WARNING: DO NOT CONNECT THIS APPLIANCE TO ANY AIR DISTRIBUTION SYSTEM OR DUCT.**

INSTALLING A VENTING SYSTEM

Attach the stovepipe sections to the stove and to each other with the crimped end toward the stove. If creosote builds up, this allows the creosote to run into the stove, and not on the outside of the stovepipe, onto the stove, or on the floor.

Secure all joints, including the connection where the stovepipe attaches to the stove's flue collar, with three sheet metal screws. Failure to properly secure the connections can result in joint failures with the stovepipe vibrating apart in the event of a creosote chimney fire. Holes pre-drilled in the flue collar accept #10 (1/8") x 1/2" (3 mm x 13mm) sheet metal screws.

Additional stovepipe accessories such as telescoping pipes, draw-bands, slip connectors, and clean-out tees greatly simplify the installation of stovepipe. These accessories also allow for easy dismantling of the stovepipe without moving the stove when you periodically inspect the stovepipe connection and chimney.

Long runs of stovepipe to increase heat dispersal are not recommended. The longer the stovepipe length and/or the larger the number of elbows, the greater the chance of draft resistance, and the greater the chance for creosote accumulation. In the past, installers strove for long runs of pipe to increase the heat dispersal. Because of the Phoenix's high efficiency, however, this is unnecessary, and unwise. Make the stovepipe as short and straight as possible. Install the stove as close as practical (maintaining all proper clearances) to the chimney. Ensure horizontal runs of pipe always rise away from the stove at a minimum of 1/4" per foot (21 mm/m).

In general, you do not need to install a stovepipe damper with the Phoenix. Some installations, however, could benefit from a stovepipe damper, such as a very tall chimney which can create a higher than normal draft. In such cases, a damper can help regulate the draft. The Phoenix requires a draft between 0.06" water column (wc) and 0.1" wc. For drafts above 0.1" wc, install a stovepipe damper.

Remember, the NFPA provides recommended, minimum clearances for chimney connectors to combustibles such as walls and ceilings. Once the stove is installed at safe distances from these combustible surfaces, it is also important to maintain these connector clearances for the remainder of the installation.

CONNECTING YOUR WOOD STOVE

You can install your Phoenix to a prefabricated metal chimney, or a masonry chimney.

CONNECTING TO A PREFABRICATED METAL CHIMNEY

When connecting the Phoenix to a prefabricated metal chimney, you must follow, precisely, the manufacturer's installation instructions. Use only Type HT (2100 deg. F), prefabricated metal chimneys listed per UL 103 or ULC S629 standards.

 **WARNING: DO NOT CONNECT THE STOVE TO A CHIMNEY FLUE SERVING ANOTHER APPLIANCE.**

Ensure the size of the chimney's flue is appropriate for the Phoenix. The Phoenix requires a 6" (152 mm) inside diameter flue for new installations. A 6" diameter flue provides adequate draft and performance. You can use an 8" (203 mm) diameter existing flue with a reducer. An oversized flue contributes to creosote accumulation. (In this case, bigger is NOT better.)

When purchasing a prefabricated chimney to install with your stove, be sure to also purchase from the same manufacturer the wall pass-through (or ceiling support package), "T" section package, fire-stops, insulation shield, roof flashing, chimney cap, and any other required accessories. Follow the manufacturer's instructions when installing the chimney and accessories. In addition, be sure to maintain all manufacturers' recommendations for the proper clearances to the chimney.

There are two ways to install a prefabricated metal chimney:

- An *interior* installation where the chimney passes inside the residence through the ceiling, additional floors or attic, and the roof.
- An *exterior* installation where the chimney passes through the wall behind the stove then up the outside of the residence to a point above the roof.

Whenever possible, choose an interior chimney installation. An interior chimney heats up more rapidly and retains its heat; thus promoting a better draft and discouraging the formation of creosote. An exterior chimney does not benefit from the warmth of being surrounded by the building, so it typically operates at lower flue temperatures. An exterior chimney's draft is not as strong and may experience increased creosote accumulation.

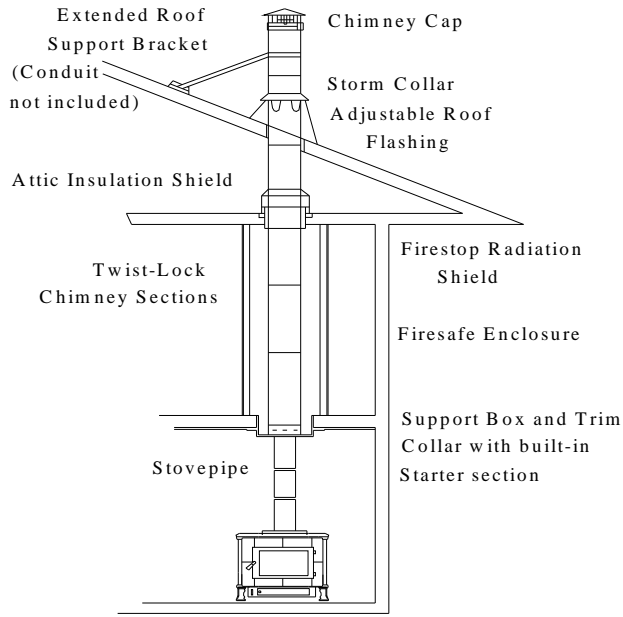

Two story house installation with attic.

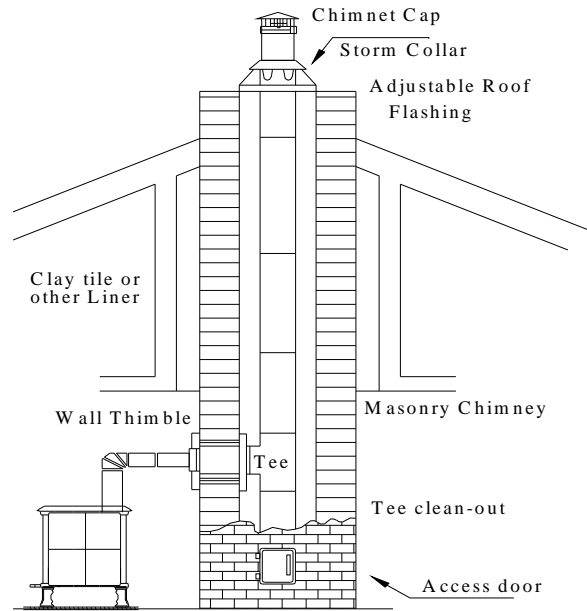

Chimney pipe through Clay tile or other Lined Masonry Chimney

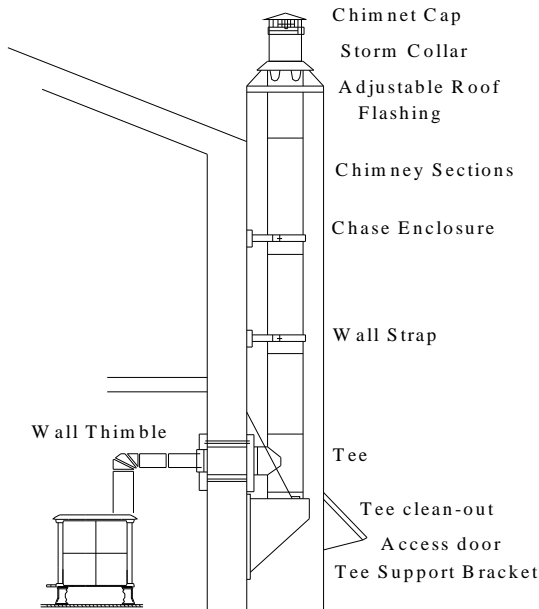

Chimney through outer wall with enclosed chase. Chimney is supported by Tee Support Bracket.

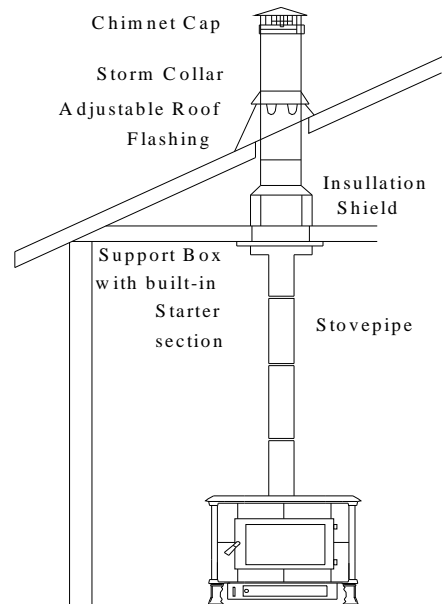

One story house installation with attic. Chimney is supported by Ceiling.

Figure 1 – Typical Venting Options

CONNECTION TO A MASONRY CHIMNEY

Consider two primary elements when connecting your stove to a masonry chimney: the chimney itself and the thimble where the stovepipe connects to the chimney. Use only Code approved masonry chimneys with a flue liner.

Before connecting to a masonry chimney, hire a professional to examine the chimney for cracks, loose mortar, other signs of deterioration, and blockage. If the chimney needs repairs, complete them before installing and using your stove. Do not install your stove until the chimney is pronounced safe for use.

Make sure the chimney's cleanout is complete and working properly. To avoid a loss of draft, ensure the cleanout closes tightly.

Make sure the size of the chimney's flue is appropriate for this stove, and that it is not too large. Use a masonry chimney with an 8" x 8" (203 mm x 203 mm) maximum tile size for best results. An oversized flue will contribute to the accumulation of creosote.

Use the following checklist to ensure that your masonry chimney meets these minimum requirements:

Chimney wall construction:

- Brick or modular block at least 4" (102 mm) thick.
- A mortared rubble or stone wall.
- Flue liner:
 - Minimum thickness of 5/8" (16 mm).
 - Installed with refractory mortar.
 - At least 1" (25 mm) air space.
- An equivalent flue liner must be a listed chimney liner system meeting type HT requirements or other approved material.
- Interior chimney requirements:
 1. At least 2" (51 mm) clearance to combustible structure.
 2. Fire stops installed at the spaces where the chimney passes through floors and/or ceiling.
 3. 2" (51 mm) gap maintained to any insulation from the chimney.
- Exterior chimney requirements:
 1. At least 1" (25 mm) clearance to combustible structure.
- Chimney height requirements: (See Figure below)
 1. At least 3 feet (0.9 m) higher than the highest part of the roof opening through which it passes.
 2. At least 2 feet (0.6 m) higher than any part of the roof within 10 feet (3 m) measured horizontally from the top of the chimney.

This stove requires a minimum chimney height of 13 feet (4 m). The maximum allowable chimney height is 30 feet (9m).

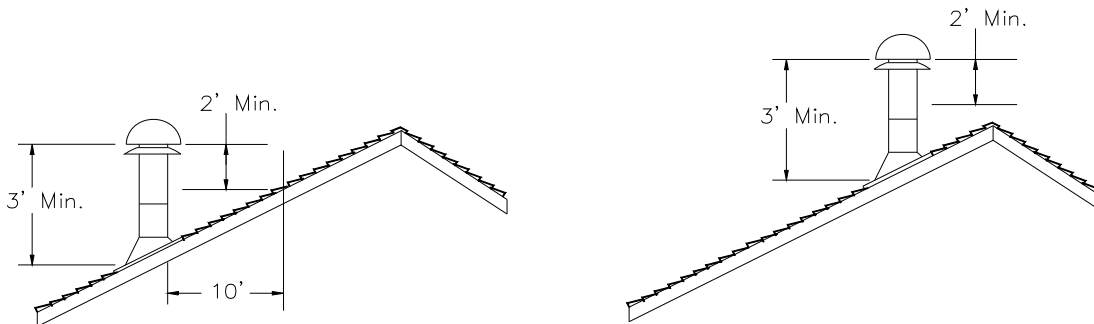

INSTALLATION IN A MOBILE HOME

Follow these special requirements for installing your stove in a mobile home.

- Install the stove in accordance with 24 CFR, Part 3280 (HUD)
- Permanently attach the stove to your mobile home's floor. Use the 1/4" holes or notches in each leg base to bolt down the stove.
- Install one of the following Dura-Vent Mobile Home Chimney & Connector Kits:
 - 6DP-MH 6" Diameter S/N 9096N
 - 7DP-MH 7" Diameter S/N 9196N
 - 8DP-MH 8" Diameter S/N 9296N

Each kit includes:

Stainless spark arrester cap, storm collar, Adjustable vented flashing – 0/12 – 6/12, two 24" Dura/Plus* chimney pipes, 24" support box with built-in starter section and trim.

* (UL or ULC approved equipment is acceptable)

- You must remove the exterior chimney sections when transporting Mobile Home.

WARNING: DO NOT INSTALL IN A ROOM USED FOR SLEEPING.

CAUTION: MAINTAIN THE STRUCTURAL INTEGRITY OF THE MOBILE HOME WALLS, FLOOR, CEILING, AND ROOF WHILE YOUR STOVE IS INSTALLED, AND IN USE.

WARNING: DISCONNECT CHIMNEY BEFORE TRANSPORTING MOBILE HOME!

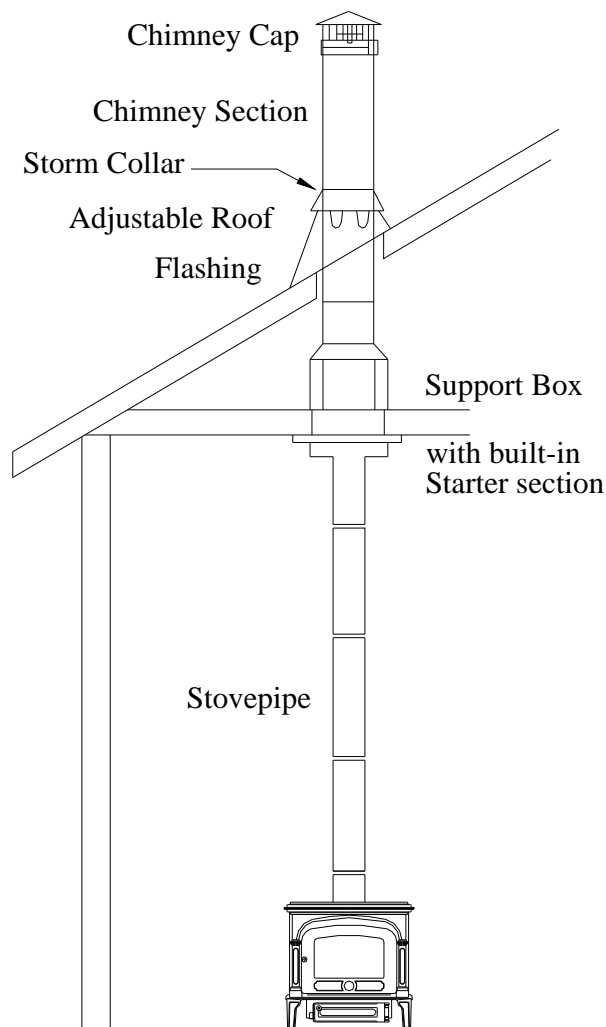

Typical Mobile Home Installation.
Chimney is supported by Ceiling.

Operation

Once your Phoenix is positioned, connected, and assembled, you are ready to light a fire.

🔥 WARNING: STOVE IS HOT WHILE IN OPERATION. KEEP CHILDREN, CLOTHING AND FURNITURE AWAY. CONTACT MAY CAUSE SKIN BURNS.

Read this entire chapter before lighting your first fire. It explains the controls and features of your wood stove, how to choose firewood, and how to break-in your stove. The chapter also covers using your stove on a daily basis.

CONTROLS AND FEATURES

Before lighting any fires, become familiar with the location, and operation, of your stove's controls and features. Learn how to use them to maximize the efficiency of your stove. For your own safety, do not modify these controls or features in any way.

PRIMARY AIR CONTROL: The handle is located on the lower front left side of the stove. The primary air control allows you to regulate the amount of air entering the firebox. Generally, the more air allowed into the firebox, the faster and hotter the rate of burn; conversely, less air creates a slower burn. To fully open the primary air intake, push the handle to the left; push the handle to the right to close the primary air control.

ASH PAN: The ash pan, and ash pan access door, is located under the ash lip. The ash pan collects ash from the fire and allows you to conveniently remove the ash from your wood stove. Clear the firebox of ashes daily by sliding the ash grate sideways, sifting the ashes across the grate into the ash pan, and then returning the grate to its closed position. The ash pan is easy to remove and has a handle for convenient disposal of ashes. The back of the ash pan assembly is sloped upwards. Before removing the ash pan, push it (hard!) into the stove to force the pan up the slope; this kicks the ashes further into the pan.

Do not operate the stove unless the ash pan is inserted into the stove and the ash door is closed. Running the stove with the ash door open could overheat and damage the stove.

CHOOSING FIREWOOD

Your Phoenix Wood Heater is designed to only burn firewood - also known as cordwood.

🔥 CAUTION: DO NOT USE CHEMICALS OR FLAMMABLE FLUIDS SUCH AS GASOLINE, NAPHTHA, KEROSENE, CHARCOAL LIGHTER FLUID OR ENGINE OIL TO START A FIRE. DO NOT USE CHARCOAL, PELLETS, COAL, WAX-SAWDUST BASED, DENSIFIED LOGS OR ANY OTHER MATERIALS AS FUEL; THEY ARE NOT SAFE. DO NOT BURN GARBAGE.

The quality of your firewood directly affects heat output, duration of burn, performance, and glass clarity of your stove. Softwoods generally burn hotter and faster, while hardwoods burn longer and produce more coals. Resinous wood can more readily affect glass clarity. Density and moisture content are two critical factors to consider when purchasing wood for your stove.

The following is a list of wood species and their relative BTU (British Thermal Unit) content. The higher the BTU content the longer the burn. Firewood with higher BTUs is generally considered ideal for a wood stove.

HIGH: Apple, Black Birch, Hickory, Locust, White Oak, Black Beech, and Mesquite.

MEDIUM HIGH: White Ash, Beech, Yellow Birch, Sugar Maple, and Red Oak

MEDIUM LOW: Black Ash, White Birch, Grey Birch, Elm, Norway Pine, Pitch Pine, Black Cherry, Soft Maple, Tamarack

LOW: White Pine, White Cedar, Balsam Fir, Spruce, Aspen, Basswood, Butternut, and Hemlock

Moisture content also plays a key role in the performance of your stove. Wood freshly cut from a living tree (green wood) contains a great deal of moisture. The heat in the firebox must evaporate that moisture before the wood can burn. As you might expect, green wood is difficult to burn. To properly season green wood: split it, stack it, and allow it to air dry for a period of one year.

Stack the firewood on skids, or blocks, to keep it off the ground, cover only the top of the stack. Plastic or tarps that cover the sides of the woodpile trap moisture and prevent drying. As for stacking, an old Vermonter said, "The spaces between the logs should be large enough for a mouse to get through, but not for the cat that's chasing it."

Do not store firewood within the stove's specified clearances to combustible materials.

BUILDING A FIRE

Once you understand the controls of your wood stove, and have chosen the appropriate firewood, you are ready to start a fire.

 **CAUTION: DO NOT USE CHEMICALS OR FLUIDS TO START A FIRE. DO NOT BURN GARBAGE OR FLAMMABLE FLUIDS SUCH AS GASOLINE, NAPHTHA, KEROSENE, CHARCOAL LIGHTER FLUID OR ENGINE OIL. DO NOT SOAK KINDLING IN FLAMMABLE LIQUIDS.**

BREAKING IN YOUR WOOD STOVE

It is imperative that your stove is "broken in" slowly (3 break-in fires recommended). Cast iron must be "seasoned"; over-firing a new stove can cause castings and stones to crack, or may damage other stove parts. Moisture in the soapstone must be driven out slowly to minimize the "shock" to the stone of its first exposure to high firebox temperatures. In addition, the heat cured asbestos-free furnace cement used in the stove must cure slowly to insure adequate sealing, and bonding.

When you light your first fires, the soapstone woodstove may emit some steam, smoke, and fumes. This is normal "off-gassing" of the moisture in the stones, and of the paints and oils used when manufacturing the wood stove. If you find it necessary, open a few windows to vent your room. The smoke and fumes will usually subside after 10 to 20 minutes of operation. The steam, odor, and smoke will end once the stove is "cured".

The first fires may produce other odors from impurities that exist in the area immediately surrounding the stove. Some of these impurities can be cleaning solvents, paint solvents, cigarettes, scented candle soot, incense smoke, pet hair, dust, adhesives, a new carpet, and new textiles. These odors will normally dissipate over time. You can alleviate these odors by opening a few windows or otherwise creating additional ventilation around your

stove. If any odor persists, contact your dealer or an authorized service technician.

If you adhere to the following break-in procedure, as well as all other operating procedures in this manual, the cast iron and soapstone components of your stove will give you many years of trouble-free use. With use, the color of the soapstone may change and small fractures may appear on the surface of the stone. These changes will only add character and distinction to your stove.

Avoid the following conditions that can cause the soapstone or cast iron pieces to break:

- Do not throw wood into the stove.
- Do not use the doors as leverage to force wood into the stove.
- Do not load wood that is encrusted with ice into a burning stove as the thermal shock can cause damage.
- Do not use a manufactured grate. Burn the fire directly on the firebrick that lines the bottom of the firebox.

The bottom layer of firebrick in the firebox is intended to prevent thermal stress and must remain in place at all times.

BUILDING A BREAK IN FIRE

- 1) Open the front door and place five or six double sheets of tightly twisted newspaper in the center of the firebox. Arrange kindling in a crisscross pattern over the newspaper. Use approximately 10 pieces of kindling, 1/2" (13 mm) in diameter and 10" to 18" (254 mm to 457 mm) long.
- 2) Fully open the primary air control by pushing the control handle to the left.
- 3) Light the paper under the kindling. Leave the door slightly ajar momentarily until the kindling has started to burn and draft begins to pull.
- 4) Close the door and allow the fire to burn. Keep the front door closed while the stove is in use. Ensure the ash grate is in the closed position and the ash door is tightly closed.

- 5) KEEP A WATCHFUL EYE ON YOUR STOVE to maintain a steady, low-heat fire. Your first three fires should **make the stove warm but not hot to the touch**. At most, a few small chunks of wood should be added to the fire to reach safe break-in temperatures.
- 6) Once the stove is **warm but not hot to the touch**, close the primary air control by pushing it fully to the right to allow the fire to die out completely.
- 7) Let the stove return to room temperature.

Your first three fires and first fire each season thereafter should be built and maintained as outlined above. Your patience will be rewarded by a properly seasoned stove.

NOTE: Because of the cool flue gas temperatures present during the break-in procedure, creosote may build up rapidly. Your glass may get dirty. A good hot fire will clean it. We recommend a visual inspection (and cleaning if necessary) of your stovepipe and chimney once the break-in procedure is completed.

NORMAL OPERATION

If your stove is not used continuously or has not been used in quite some time, follow the break-in procedure at least once to minimize the stress of a hot fire on a cold stove before proceeding with normal operation. We recommend one break-in fire at the start of each heating season. Prior to loading the stove, make sure the ash grate and the ash pan door are closed. If any doors are left open, an over-fire can damage the stove.

BUILDING A FIRE FOR EVERYDAY USE

- 1) Open the door and place five or six double sheets of tightly twisted newspaper in the center of the firebox. Arrange kindling in a crisscross pattern over the newspaper. Use approximately 10 pieces of kindling, 1/2" (13 mm) in diameter and 10" to 18" (254 mm to 457 mm) long.
- 2) Fully open the primary air control by pushing the control handle to the left.
- 3) Light the paper under the kindling. Leave the door slightly ajar momentarily until the

kindling has started to burn and draft begins to pull.

- 4) Close the door and allow the fire to burn.
- 5) Once the kindling is burning, open the door and add logs, small at first, to build the fire up. Make sure to keep the logs away from the glass in front in order for the air-wash system to work properly. Otherwise, keep the front door and ash door closed while the stove is in use.
- 6) Once the fire is burning well, use the primary air control to regulate the desired rate of burn. Push the handle to the left to open the PRIMARY AIR CONTROL for a high rate of burn & push it to the right for a low rate of burn.

Note: When opening the door to reload or rearrange logs, it is advisable to open the door just a crack, pause for a moment then open the door completely. This procedure will allow the firebox to clear of smoke before the door is opened fully. In addition, reloading on a bed of hot, red coals reduces smoking time and will bring fresh fuel up to a high temperature rapidly.

BURN RATE

HIGH BURN: Fully load the firebox with wood on a bed of hot coals or on an actively flaming fire and fully open the primary air control by pushing it to the left. This will fully uncover the primary air shutter. A high burn rate is recommended once or twice a day to fully heat the stovepipe and chimney, which will help minimize creosote accumulation.

MEDIUM HIGH BURN: With the primary air control in the open position, push the control handle to the right approximately 1/4".

MEDIUM LOW BURN: With the primary air control in the open position, push the handle to the right 1". A medium-low burn rate is the typical setting and is preferable if the stove is left unattended.

LOW BURN: Close the primary air control by pushing it to the right until it stops. A low burn rate over extended periods is not advisable as it may promote the accumulation of creosote. Inspect the venting system frequently if low burn rates are maintained consistently.

OVER-FIRE CAUTION

Over-firing means the stove is operating at temperatures above the recommended temperatures outlined above in the *BURN RATE* section. Carefully avoid over-firing since it will cause damage to the stove. Symptoms of over-firing include short burn times, a roaring sound in the stove or stovepipe, and discoloration of the stovepipe.

Over-firing can be caused by excessive draft, inappropriate fuel, and operator error. Correct an over-fire situation as follows:

EXCESSIVE DRAFT: Contact your dealer to have a draft reading taken. Any draft in excess of 0.1 inch water column requires a damper in the stovepipe. Some installations may require more than one damper.

INAPPROPRIATE FUEL: Do not burn coal; green wood, kiln dried lumber, wax logs or anything other than natural, seasoned cordwood.

OPERATOR ERROR: Make sure all the gaskets are in good condition. Replace worn out or compressed gaskets. Do not burn the stove with the front, and ash door, as well as the ash grate in the open position.

Monitoring the temperature of the surface of the top stones is the best way to determine if the stove is over-firing. If you suspect that your stove is over-firing, contact your dealer immediately. **Damage done by over-firing is not covered by your warranty.** Results of over-firing can include: warped or burned out internal parts, cracked stones, discolored or warped external parts, and damaged enamel.

 **NOTE: ANY SYMPTOMS OF OVER-FIRING WILL VOID YOUR WARRANTY!!**

REMOVAL AND DISPOSAL OF ASHES

Remove ashes only when the stove is cold. Use protective fireplace gloves when the ash pan is warm. Exercise extreme caution when handling, storing or disposing of ashes.

The ash pan and ash pan access door are located under the ash lip. The ash pan collects ash from the fire and allows you to conveniently remove the ash from your wood stove. The firebox can be cleared of ashes daily by sliding the ash grate sideways, sifting the ashes across the grate into the ash pan, and then returning the grate to its closed position. The ash pan is easy to remove and has a handle for convenient

disposal of ashes. The back of the ash pan assembly is sloped upwards. Before removing the ash pan, push it (hard!) into the stove to force the pan up the slope, this kicks the ashes further into the pan.

Carefully dump ashes from the ash drawer into a **metal** container with a tight fitting lid. Do not place any other items or trash into the metal container. Replace the lid on the container and allow the ashes to cool, preferably outside your home. Do not place the ash disposal container on a combustible surface or vinyl flooring, as the container could contain live coals and be **hot!**

Pending disposal, place the closed ash container outside your living space on a noncombustible floor (bare concrete) or on the ground, well away from all combustible materials. Retain ashes in the closed container until all cinders have thoroughly cooled.

NEVER place ashes in wooden or plastic containers. Do not put them in paper or plastic bags either, no matter how long since the fire has gone out. Coals within a bed of ashes can remain hot for several days, and can revive once removed from the firebox and exposed to air.

MAINTENANCE

Contact your dealer for any parts, or service.

MONITORING STOVE TEMPERATURES

Monitor the stove temperatures with a stove thermometer (available from your dealer) placed on the top center stone of the stove. The thermometer could read as high as 500°F (260°C) on High Burn and 200°F (95°C) on low burn. Maintaining temperatures in excess of 500°F (260°C) will cause the stones to crack and cause other damage to the stove.

Do not over-fire the stove. (Refer to page 22).

Damage done by over-firing will void the warranty.

CREOSOTE FORMATION AND NEED FOR REMOVAL

When wood is burned slowly, it produces tar and other organic vapors, which combine with expelled moisture to form creosote. These creosote vapors condense in the relatively cool chimney flue of a slow-burning fire. As a result, creosote residue accumulates on the flue lining. When ignited, this creosote makes an extremely hot fire, which may damage the chimney, or even destroy the house. When burning wood, the chimney connector and chimney should be inspected at least once every two months during the heating season to determine if a creosote buildup has occurred.

To prevent the buildup of creosote:

1. Burn only seasoned (dry) cordwood.
2. Burn the stove with the primary air control fully open for 35 - 45 minutes daily to burn out creosote deposits from within the stove and the venting system (do not over-fire).
3. After reloading with wood, burn the stove with the primary air control fully open for 20 to 30 minutes. This manner of operation ensures early engagement of the secondary combustion system, which greatly minimizes creosote buildup in the chimney.

Inspect the stovepipe connector and chimney at least bi-monthly during the heating season to determine if creosote build-up has occurred. If a creosote residue greater than 1/4" (6 mm) has accumulated, remove it promptly to reduce the risk of a chimney fire.

If your glass remains dirty, your stove's operating temperatures are probably consistently lower than normal; therefore, there is a higher risk of creosote buildup.

The venting system must be inspected at the stove connection, *and* at the chimney top. Cooler surfaces tend to build creosote deposits faster, so it is important to check the chimney at the top (where it is coolest) as well as from the bottom near the stove.

Remove accumulated creosote with a cleaning brush specifically designed for the type of chimney in use. Use a certified chimney sweep to perform this service. Contact your dealer for the name of a

certified chimney sweep in your area (your dealer may be a certified sweep!).

We also recommend that you have the entire heating and venting system professionally inspected, cleaned and repaired, if necessary, before each heating season.

GASKETS

Replace gasket material every two to three seasons, depending on stove use. If the door seal is loose, a new gasket will assure a tight seal and improved stove performance. Contact your dealer for a gasket kit that includes instructions and gaskets for your stove.

The procedure for replacing gaskets on the glass is reviewed on page 22 – Glass.

To replace door gaskets, first remove the old gaskets with a utility or putty knife. Clean all gasket channels with a wire brush. Apply gasket cement (where needed) to the channels and push the new gasket into place without stretching the gasket material. Close the door immediately to fully press the gasket into place and assure a positive seal.

We require the use of the following gaskets:

GLASS: 54" (137 cm) Length, 3/4" (1.9 cm) Wide, Adhesive Backed Black Tape

FRONT DOOR: 60" (152 cm) Length, 3/8" (.95 cm) Diameter, Low Density Black Tube

ASH DOOR: 30" (76 cm) Length, 1/4" (.64 cm) Diameter, Low Density, Black Tube

GLASS

Do not operate the stove with a broken door glass. Do not abuse the front door by striking or slamming.

When necessary, the glass can be cleaned with low alkaline content commercial stove glass cleaners, which are available from your local dealer. Never attempt to clean the glass while the fire is burning or the glass is hot. Most deposits can be cleaned by following the instructions provided with the cleaner. To clean heavier deposits, open the door and lift it straight up and off the stove with the hinge pins remaining in the door (take care to save hinge pins and any washers for reuse). Lay the door face down

on a workbench or table. Apply the cleaner to the glass and allow it to sit for a few minutes. By laying the door flat, it will allow the cleaner to penetrate the deposits rather than just running off the surface of the glass. Wipe the cleaner off with a soft cloth.

Important: scratching or etching the glass will weaken the integrity of the glass. Do not use a razor blade, steel wool, or any other abrasive material to clean the glass. Use low alkaline content cleaners only.

The front door glass is a ceramic, shock-resistant glass, made specifically for use in woodstoves. Do not use any replacement glass other than the ceramic glass manufactured and supplied for use in this woodstove. Replacement glass is available through your local dealer.

Replace the door glass immediately if broken. Contact your local dealer for replacement glass, which is accompanied with instructions and everything needed for the repair. If you replace the glass yourself, wear suitable work gloves and safety glasses.

The procedure for glass and glass gasket replacement is as follows:

1. Remove the door by lifting it straight up off the hinges with the hinge pins remaining in the door.
2. Place the door face down on a flat, smooth surface.
3. Apply penetrating oil to the screws in the glass retainer clips. Remove the screws to separate the glass from the door.
4. Carefully lift the damaged glass from the door and discard.

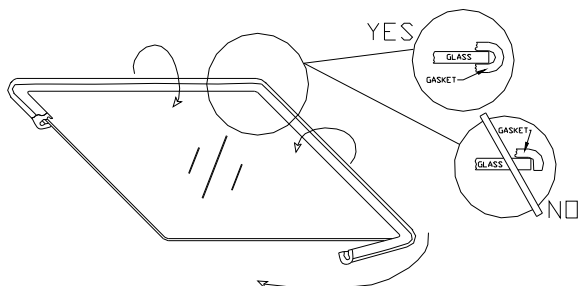

5. Peel the paper backing from the tape gasket. Apply the new gasket to the new glass as illustrated above.
6. Place the gasketed glass onto the door.

7. Screw the glass retainer clips back on the door.
8. Install the door.

STONE

To maintain the natural beauty of your stove's polished soapstone finish, only occasional cleaning is necessary. Clean the soapstone with water, any non-abrasive cleaner and a soft cloth. Wipe dust from the stone with a clean cloth. Soapstone is porous - do not use chemical agents to wash the stone; do not use waxes or any polishing agents on the stone.

Care must be taken not to scratch or chip the stone. Do not set items, which can scratch or chip the stone (or enamel finish), on top of your stove.

Often, with use, and over time, subtle earth tones of brown, red, and yellow appear in the soapstone. This is a natural reaction in the soapstone. Surface or hairline fractures may also appear in the stone after a stove is used. Such changes are normal and do not affect the operation or the integrity of the stove and do not require replacement. If you observe a completely broken stone, contact your dealer for service.

CAST IRON

Exterior cast iron parts are either painted with black, high-temperature stove paint or porcelainized with an enamel finish in various colors.

Use black, high-temperature stove paint (satin black by Stovebright for example) to touch up and maintain the original appearance of painted cast iron. Use a damp sponge to wipe clean. Dry the cast iron thoroughly to prevent rusting.

Enamel castings can be cleaned with a standard glass cleaner. With time and use, a very fine, subtle network of crazed lines may appear seemingly beneath the surface of the enamel. Crazing is a natural predictable process and does not represent a flaw.

TROUBLESHOOTING

Virtually all woodstove operators experience basic common problems at one time or another. Most are correctable and generally require only a minor adjustment of the stove, installation, or operating technique. In cases where weather conditions dramatically affect stove performance, the problems are typically temporary and solve themselves once the weather changes.

If you question whether your stove is producing adequate heat, the best way to troubleshoot the problem is to monitor the temperature of the stack. A 400 degree F (200 degree C) stovepipe confirms the stove is supplying sufficient heat. Keep in mind that your house itself will regulate room/house temperatures. How well the walls, floors and ceilings are insulated, the number and size of glass windows, the tightness of outside doors, and the construction or style of your house (vaulted ceilings or other open spaces which collect large percentages of heat, ceiling fans, etc.) all are determining factors of room temperature.

Your stove's performance is also dependant on its installation. One common cause of poor performance is an oversized chimney flue. Oversized chimney flues result in decreased velocity (draft), which prevents the smoke from rising out the chimney quickly. Oversized flues are also more difficult to heat effectively, especially when burning a high efficiency stove. Cool flue temperatures inhibit the establishment of a strong draft (and encourage the accumulation of creosote). The lack of a strong draft will cause the fire to die down and may even force the smoke to enter into the room.

If your chimney is the proper size, and a strong draft is not easily established, there is the possibility of the chimney being too cold. Again, hot chimneys promote a stronger draft.

Other draft guidelines are as follows:

An **"AIRTIGHT" HOUSE:** If your home is super-insulated or especially well sealed, the (infiltration) air supply to the interior of the house can be inadequate. This phenomenon of air starvation within the building can be exacerbated if exhaust fans, such as clothes

dryers, bathroom fans or cook stove exhaust fans, are in operation within the home. Outfitting your stove with the optional outside air supply adaptor connected to an air duct leading to the outside of the building should correct this problem.

TALL TREES OR BUILDINGS: These obstructions, when located in close proximity to the top of the chimney can cause chronic or occasional downdrafts. When selecting a site for a new chimney, take care to consider the placement of other objects near the proposed chimney location.

WIND VELOCITY: Generally, the stronger and steadier a wind, the stronger (better) the draft. However, "gusty" wind conditions may cause erratic downdrafts.

BAROMETRIC PRESSURE: Chimney drafts are typically sluggish on balmy, wet or muggy days (low, or dropping atmospheric pressure). This is a weather-related phenomenon, which generally is self-correcting as the weather changes.

BRISKNESS OF FIRE: The hotter the fire in your stove, the hotter your chimney and, therefore, the stronger the draft.

BREAKS IN THE VENTING SYSTEM: An unsealed clean-out door at the bottom of the chimney, leaky stovepipe joints, a poor stovepipe-to-thimble connection, or a leaky chimney may cause inadequate draft.

SEASONAL FACTORS: Early fall and late spring are generally difficult seasons in which to establish proper drafts. Generally, the colder the outside air is (relative to room temperature) the stronger the draft.

Operating the Stove

There are days when a draft is not easily established. As outlined above, seasonal factors, or a cold chimney may be the cause. Try starting the fire using only small kindling and wood to obtain a quick, hot fire. Tend the fire frequently with small, dry fuel until the chimney is hot and the draft is well established. Slightly opening a window in the same room as the stove during startup can help too.

TROUBLESHOOTING GUIDE

PROBLEM	POSSIBLE CAUSE	SOLUTIONS
STOVE SMOKES	<p>Operating Technique</p> <p>Cold Chimney Blocked Chimney</p> <p>Oversized Chimney Undersized Chimney Chimney Too Short Air Infiltration Into The Chimney More Than One Appliance Connected to the Flue</p>	<p>Fully open the primary air control one minute before opening doors.</p> <p>Preheat the chimney when first starting a fire.</p> <p>Examine the chimney and stovepipe for blockage or creosote accumulations.</p> <p>Reline the chimney to the appropriate diameter</p> <p>Install a draft inducer or replace the chimney.</p> <p>Lengthen the chimney.</p> <p>Seal chimney connections and openings in clean-out doors.</p> <p>Disconnect all other appliances and seal openings.</p>
BACK-PUFFING OR GAS EXPLOSIONS	<p>Operating Technique</p> <p>Extra Low Burn Rate Chimney Down-draft Excessive Ash Build-up</p>	<p>Fully open the primary air control one minute before opening the door and keep it fully open for a few minutes after reloading.</p> <p>Burn the stove at a higher burn rate.</p> <p>Install a chimney cap.</p> <p>Empty ash pan more frequently.</p>
UNCONTROLLED OR SHORT BURN	<p>Unsealed or Open Door Open ash grate Excessive Draft</p> <p>Deteriorated Cement Seals Extra Long Chimney Oversized Chimney High Winds or Hilltop Location: Excessive Draft</p>	<p>Close the door tightly or replace the gaskets.</p> <p>Slide ash grate to closed position.</p> <p>Check the installation. Operate at LOW BURN. Install stovepipe damper.</p> <p>Reseal the stove with furnace cement.</p> <p>Shorten the chimney. Install stovepipe damper.</p> <p>Reline the chimney to the proper diameter.</p> <p>Install a chimney cap.</p> <p>Draft in excess of 0.1 wc should be corrected with a stovepipe damper</p>
INSUFFICIENT HEAT AND/OR DIRTY GLASS	<p>Poor Quality or Green Wood</p> <p>Low Burn Rate Air Insulated Chimney</p> <p>Cold Exterior Chimney Leaky Stovepipe or Chimney Too Much Heat Loss From House</p>	<p>Use only air-dried wood, preferably dried <u>at least</u> one year.</p> <p>Operate the stove at a higher burn rate.</p> <p>Replace with a pre-fabricated insulated chimney system or a properly sized masonry chimney.</p> <p>Reline or insulate the chimney.</p> <p>Check the installation.</p> <p>Caulk windows, seal openings in home.</p>
BLISTERING OF ENAMEL CASTING	<p>Operating Technique</p> <p>Excessive Draft</p>	<p>Do not over-fire the stove. Monitor stove temperatures. Use seasoned cordwood only.</p> <p>Check the DRAFT. A damper may be required. Operate the stove at a LOW BURN range.</p>

REPLACEMENT PARTS & OPTIONAL ACCESSORIES

PART NUMBER:	DESCRIPTION:	PART NUMBER:	DESCRIPTION:
1641-301	SIDE STONES (8) 7-3/4 x 9-1/8	5010-080	HANDLE CRANK 45° (2)
1641-302	TOP SIDE STONES 6-17/32 x 16	5600-024	ASH PAN
1641-303	TOP CENTER STONE 10-3/4 x 11-1/8	5600-030	FRONT DOOR CATCH
26XX-003	TOP CASTING	5600-040	PRIMARY AIR PLENUM
26XX-004	FRONT PANEL	5600-041	SECONDARY AIR PIPE (TUBE 1)
26XX-005	FRONT DOOR	5600-042	SECONDARY AIR PIPE (TUBE 2)
26XX-006A	BOTTOM LEG	5600-043	SECONDARY AIR PIPE (TUBE 3)
26XX-009	SIDE RIB	5600-044	AIR TUBE RISER
26XX-010	ASH LIP	5600-045	SECONDARY AIR PLENUM
2610-011	ASH PAN DOOR	5600-046	AIR TUBE LOCATOR
2610-012	ASH PAN DOOR FRAME	5600-052	FRONT DOOR HINGE
26XX-016	FLUE COLLAR		
2610-017	GRATE FRAME		
2610-018	GRATE	5930-2000	REAR HEAT SHIELD
26XX-019	BOTTOM CASTING	5950-016	OUTSIDE AIR KIT
26XX-020	REAR PANEL		
3030-020	IR GLASS 10-1/4 x 15-5/8 x 5mm		
3060-426	FIREBRICK 4-1/2 x 9 x 1-1/4		
3060-428	FIREBRICK 6-3/8 x 11-3/4 x 1-1/4		
3060-430	FIREBRICK 4 x 9 x 1-1/4		
3120-210	CERAMIC BLANKET (11 X 22)		
3120-282	CERMIC BOARD 9-1/8 x 9-3/4		
3120-284	CERAMIC BOARD 5-1/4 x 14-1/2		
3900-177	WOOD HANDLES (2)		
5012-052	AIR INLET/ASH PAN BOX		
	PRIMARY AIR CONTROL SLIDER		
5012-056	ARM		
	PRIMARY AIR CONTROL SLIDER		
5012-057	HANDLE		
5012-066	PRIMARY SHUTTER BUSHING		
5012-304	FRONT BAFFLE SUPPORT		
5400-2202A	ASH DOOR SHAFT		
5400-2205	DOOR LATCH/SHAFT		





Hearthstone Woodstove Limited Warranties

These warranties give you specific legal rights. You may also have other rights which vary from State to State.

Hearthstone Quality Home Heating Products, Inc. (Hearthstone) warrants to the original purchaser only (the “Original Purchaser”) the new woodstove manufactured by Hearthstone and purchased by the Original Purchaser (the “Woodstove”) against any of the occurrences listed in this document that result from defects in material or workmanship. All obligations of Hearthstone under this document commence on the date the Original Purchaser purchases the Woodstove (the “Purchase Date”).



LIMITED LIFETIME WARRANTY

Hearthstone warrants the following parts of the Woodstove against the following occurrences that result from defects in material and workmanship:

-  All cast iron parts – against breakage, cracking or burn-through.
-  All stones – against cracking or breakage due to thermal stress, **excluding** surface and hairline cracks and scratches that do not affect the operation or safety of the Woodstove.
-  Primary and secondary air supply systems, including riser tubes, air wash system, secondary air manifold and stainless steel secondary air supply tubes – against breakage, cracking or burn-through.
-  Glass – against breakage due to thermal shock.

LIMITED FIVE-YEAR WARRANTY



Hearthstone warrants the following parts of the Woodstove against the following occurrences that result from defects in material and workmanship:

-  Refractory brick – against breakage and deterioration **not** resulting from physical damage or over-loading of the Woodstove.
-  Firebox baffle (the baffle above the secondary air tubes) – against breakage, cracking or burn-through.
-  Door handles and latch mechanisms – against breakage.

This warranty expires on the fifth (5th) anniversary of the Purchase Date.

LIMITED ONE-YEAR WARRANTY

Hearthstone warrants the following parts of the Woodstove against the following occurrences that result from defects in material and workmanship:

-  Enamel Finish – against peeling or fading, **excluding** chipping, mechanical abrasion, chemical abrasion or crazing.
-  Stove cement and all gaskets – against breakage or deterioration.
-  Accessories and electrical components such as blowers, switches and thermo discs, **excluding** venting components, hearth components, electrical components and other components or accessories used in conjunction with the installation of the Woodstove **not** manufactured or supplied by Hearthstone – against breakage or malfunction.

This warranty expires on the first (1st) anniversary of the Purchase Date.

EXCLUSIONS

The warranties contained in this document do not cover, nor is Hearthstone responsible for:

1. Damage resulting from installation or operation of the Woodstove in a manner contrary to the owner's manual.
2. Damage to the Woodstove or cracking of stones due to improper break-in firing procedures.
3. Damage or non-performance resulting from faulty or incomplete setup, installation and start-up or mishandling, abuse, or misuse of the Woodstove, including but not limited to over-firing.
4. Damage resulting from installation, modification, alteration, repair or service of the Woodstove by any party other than Hearthstone or an authorized Hearthstone dealer (a "Dealer").
5. Damage resulting from the use as fuel of driftwood, treated wood, wax, artificial or manufactured logs, coal or other material other than natural wood.
6. Damage due to water or due to installation of the Woodstove in a damp or high condensation area.
7. Damage due to installation of the Woodstove in an atmosphere contaminated by damaging chemicals, including but not limited to chlorine, fluorine or salts.
8. Scratches on glass, enameled surfaces or stones due to mechanical abrasion.
9. Standard wear and tear of the Woodstove resulting from normal usage over time.
10. Damage resulting from operational-related problems such as over-firing, downdrafts, smoke spillage, or use of corrosive driftwood.
11. Damage or inadequate performance caused by site, installation or environmental conditions beyond Hearthstone's control, including but not limited to nearby trees, rooftops, buildings, wind, hills, mountains, inadequate or excessive venting, insufficient make up air, or negative air pressure whether or not caused by mechanical systems such as furnaces, exhaust fans, clothes dryers, etc.
12. A defect in any part of the Woodstove if the Original Purchaser fails to comply with Hearthstone's or a Dealer's request to ship the part or the Woodstove to Hearthstone or a Dealer, as the case may be.

THE WARRANTIES CONTAINED IN THIS DOCUMENT ARE EXCLUSIVE AND ARE GIVEN BY HEARTHSTONE AND ACCEPTED BY THE ORIGINAL PURCHASER IN LIEU OF ALL OTHER EXPRESS WARRANTIES AND ANY OBLIGATIONS, LIABILITIES, RIGHTS, CLAIMS, OR REMEDIES IN CONTRACT OR TORT, WHETHER OR NOT ARISING FROM HEARTHSTONE'S NEGLIGENCE, ACTUAL OR IMPUTED. ALL IMPLIED WARRANTIES, INCLUDING THE WARRANTIES OF MERCHANTABILITY AND FITNESS FOR A PARTICULAR PURPOSE, ARE GIVEN **ONLY** TO THE EXTENT REQUIRED BY FEDERAL OR STATE LAW. EXCEPT AS OTHERWISE REQUIRED BY STATE LAW, UPON THE EXPIRATION OF THE EXPRESS LIMITED WARRANTIES CONTAINED HEREIN, **NO** IMPLIED WARRANTIES, INCLUDING THE IMPLIED WARRANTIES OF MERCHANTABILITY OR FITNESS FOR A PARTICULAR PURPOSE, SHALL APPLY TO THE SUBJECT WOODSTOVE. **SOME STATES DO NOT ALLOW LIMITATIONS ON HOW LONG AN IMPLIED WARRANTY LASTS, SO THE ABOVE LIMITATION MAY NOT APPLY TO YOU.**

THE WARRANTIES CONTAINED IN THIS DOCUMENT EXTEND **ONLY** TO THE ORIGINAL PURCHASER OF THE WOODSTOVE WARRANTED HEREUNDER. THEY DO NOT EXTEND TO ANY SUBSEQUENT OWNERS.

UNDER NO CIRCUMSTANCES SHALL HEARTHSTONE BE LIABLE TO THE ORIGINAL PURCHASER OR ANY OTHER PERSON FOR ANY INCIDENTAL OR CONSEQUENTIAL DAMAGES, INCLUDING BUT NOT LIMITED TO DAMAGE TO PROPERTY OR PERSONAL INJURIES, WHETHER ARISING OUT OF BREACH OF WARRANTY, TORT, OR OTHERWISE, EVEN IF HEARTHSTONE HAS BEEN APPRAISED OF THE POSSIBILITY OF SUCH DAMAGES. **SOME STATES DO NOT ALLOW THE EXCLUSION OR LIMITATION OF INCIDENTAL OR CONSEQUENTIAL DAMAGES, SO THE ABOVE LIMITATION OR EXCLUSION MAY NOT APPLY TO YOU.**

QUALIFYING FOR WARRANTY COVERAGE

To obtain performance of any obligation under this document, the Original Purchaser must, **within the applicable warranty time period**, contact their Hearthstone dealer, for instructions regarding the return of defective parts for repair, the return of the Woodstove for repair, or a Dealer service call. The Original Purchaser should refer to the Dealer Network search engine contained on Hearthstone's Web site (www.hearthstonestoves.com) if the original dealer is not available, to find a Hearthstone dealer nearest the Original Purchaser's location.

REMEDY

The remedy for any breach of the foregoing warranties will consist of repair or replacement, at Hearthstone's option, of any covered defect in the Woodstove. When the Original Purchaser contacts a Hearthstone Dealer, the Dealer or Hearthstone, as the case may be, will instruct the Original Purchaser to **either** return the defective part, or the entire Woodstove (if needed), with shipping prepaid, to a Dealer or Hearthstone **or** allow a Dealer to make a service call at the place where the Woodstove is located. In the event the Original Purchaser refuses to allow a Dealer to make a service call, a Dealer or Hearthstone, as the case may be, will request that the Original Owner return the defective part, or the entire Woodstove (if needed), with shipping prepaid, to a Dealer or Hearthstone. **Notwithstanding any other provision of this document, the Original Purchaser shall pay for any travel fees and service charges related to a Dealer's service call.**

Parts: Hearthstone will replace through an authorized dealer, defective parts covered by the foregoing warranties at no charge.

Labor: Within the first (1st) year after the Purchase Date, Hearthstone will pay for warranty labor performed by an authorized Dealer at Hearthstone's published labor rates in effect at the time the labor is performed. Thereafter, the Original Purchaser is responsible for the cost of labor.

Shipping cost for parts: Within the first ninety (90) days after the Purchase Date, Hearthstone will pay for the shipping of Woodstove parts covered by any of the foregoing warranties to and from Hearthstone or an authorized Dealer, as the case may be. Thereafter, the Original Purchaser is responsible for all shipping costs related to shipping Woodstove parts to and from Hearthstone or an authorized Dealer, as the case may be.

Shipping cost for the Woodstove: Within the first (1st) year after the Purchase Date, if the Original Purchaser is instructed to return the Woodstove to Hearthstone or an authorized Dealer for repair, Hearthstone will pay fifty percent (50%) and the Original Purchaser will pay fifty percent (50%) of the shipping costs related to shipping the Woodstove to and from Hearthstone or an authorized Dealer, as the case may be. Thereafter, the Original Purchaser is responsible for one hundred percent (100%) of all of the shipping costs related to shipping the Woodstove to and from Hearthstone or an authorized Dealer, as the case may be. Notwithstanding any other provision of this document, in no event will Hearthstone pay for any Dealer fees or other fees for pick up or delivery of the Woodstove returned for repair; the Original Purchaser shall be responsible for any such fees.

WARRANTY REGISTRATION

The Original Purchaser can complete their warranty registration on our website at www.hearthstonestoves.com, or send a completed and signed Warranty Registration Form, which is enclosed in the Woodstove warranty packet, to the following address:

Hearthstone Quality Home Heating Products, Inc.
Warranty Department
317 Stafford Avenue
Morrisville, VT 05661

 **NOTE: SENDING IN THE SIGNED WARRANTY REGISTRATION FORM IS NOT REQUIRED AS A CONDITION OF WARRANTY COVERAGE OR HEARTHSTONE'S PERFORMANCE.**