

847-141-5903  
Majestic Dealer

# Majestic THULMAN® FIREPLACE & CHIMNEY INSTALLATION INSTRUCTIONS

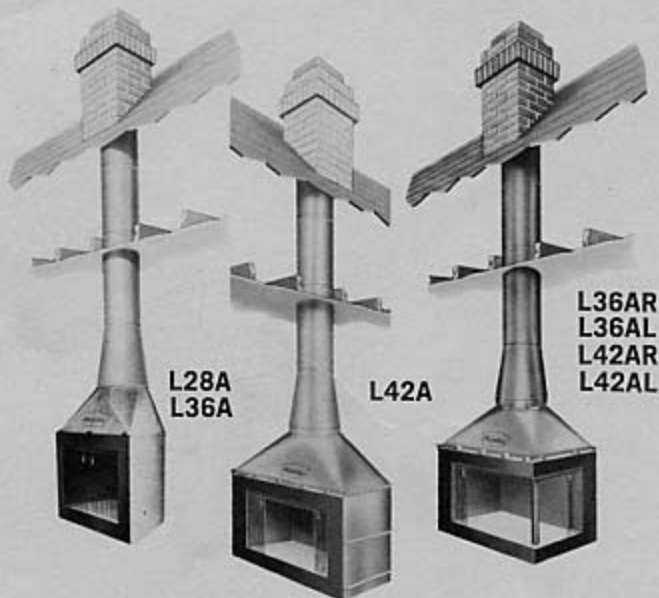

**Model L28A — OPEN FRONT**  
**Models L36A and L42A — OPEN FRONT**  
**Models L36AR and L42AR — OPEN RIGHT END**  
**Models L36AL and L42AL — OPEN LEFT END**

**READ INSTRUCTIONS CAREFULLY;  
REFER TO YOUR MODEL NUMBER**

## LOCAL CODES:

Local Building Codes should be consulted in all cases as to the particular requirements concerning the installation of factory-built fireplaces. Majestic Thulman Fireplaces are intended for use in accordance with Standard NFPA #211 of the National Fire Protection Association.

## CLEARANCES:

Any of these models may be placed directly on a combustible floor, against a combustible wall or raised on a wooden platform without clearance from combustible construction. Framing members may be placed directly against the side and back of the fireplace. Combustible floors must be protected at front and sides of openings, as shown below. Combustible walls, at right angles and within 40" of fireplace opening, must be protected as shown below. L28A, L36A sections require 2" clearance, and L42A sections require 1" clearance to combustibles.

Majestic Thulman fireplaces have the following guarantees, approvals, recommendations or listings:

 71-21 (Building Officials Code Administration)	INTERNATIONAL CONFERENCE OF BUILDING OFFICIALS REPORT NO. 1581	 No. 7177 (Southern Building Code Congress)
	 SINCE 1907	

Look for the U.L. Label on the Fireplace

Listed under one or more of the following U. S. Patents: 2634720; 2856837; and 2821975.

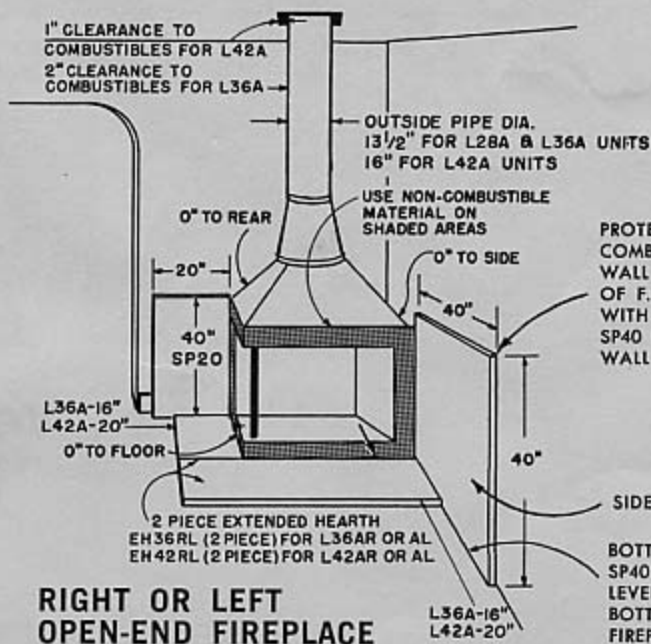
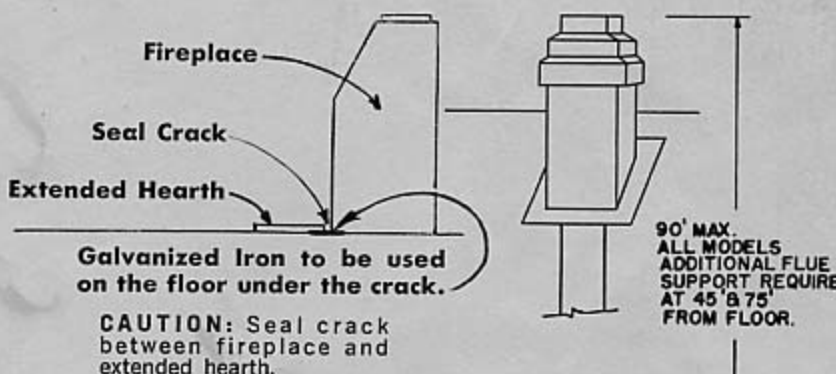

PROTECT ADJACENT COMBUSTIBLE SIDE WALL WITHIN 40" OF F.P. OPENING WITH MAJESTIC SP40 INSULATED WALL PANEL

SIDE WALL

BOTTOM OF SP40 TO BE LEVEL WITH BOTTOM OF FIREPLACE

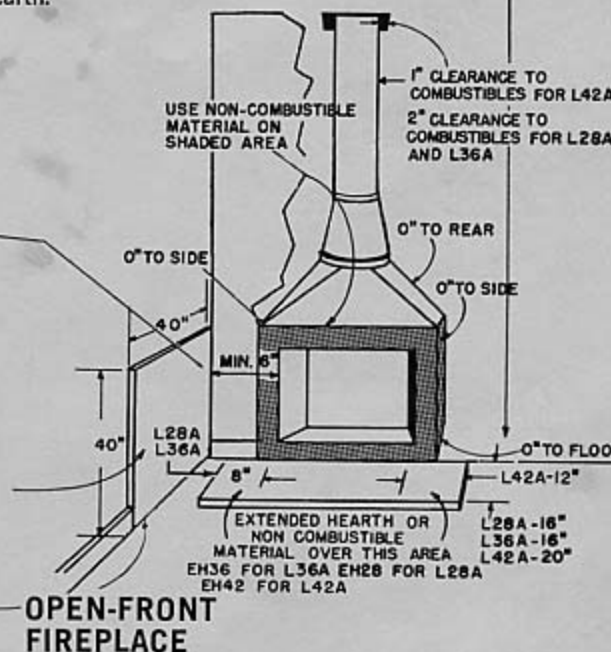

**DIMENSIONS FOR FRAMING:**

See Framing Instructions  
on Page 5.

**CORNER INSTALLATION**

**Model L28A**

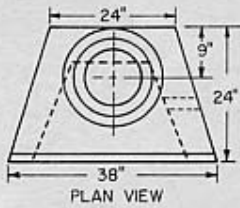

PLAN VIEW

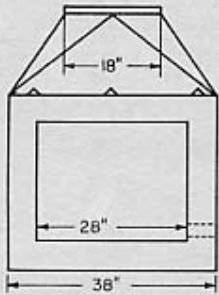

FRONT

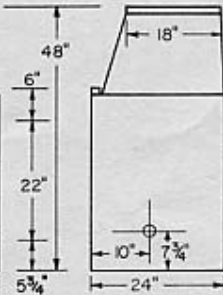

SIDE

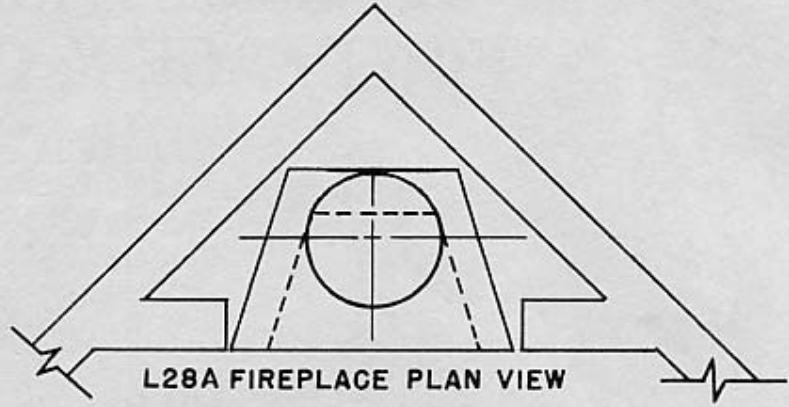

L28A FIREPLACE PLAN VIEW

**Model L36A**

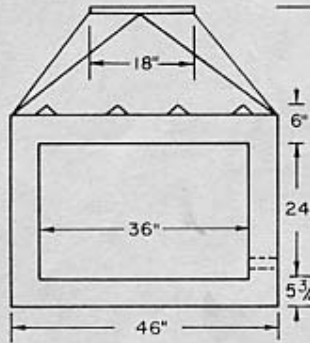
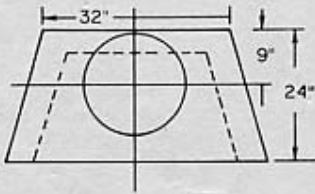

FRONT

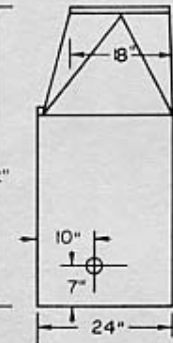

SIDE

**Models L36AR  
& L36AL (shown)**

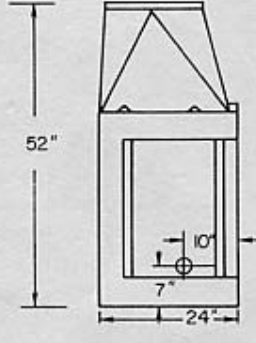
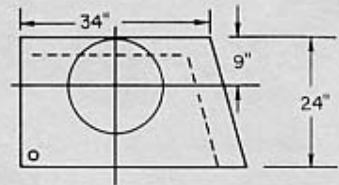

SIDE

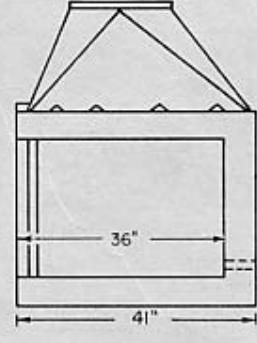

FRONT

**Model L42A**

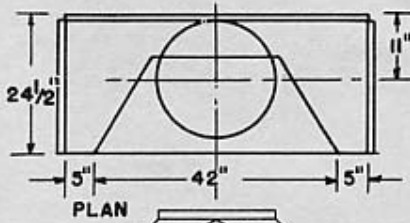

PLAN

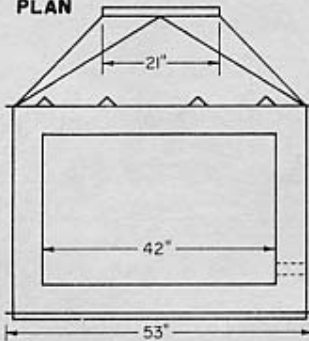

FRONT

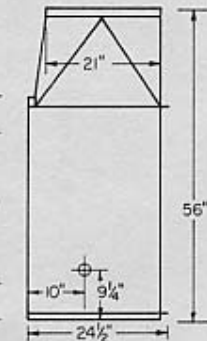

SIDE

**Models L42AR  
& L42AL (shown)**

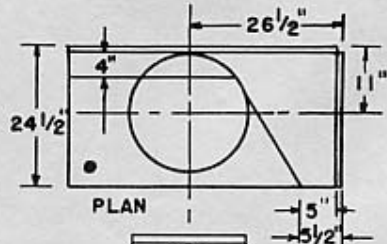

PLAN

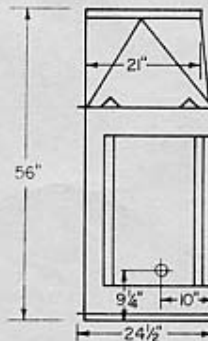

SIDE

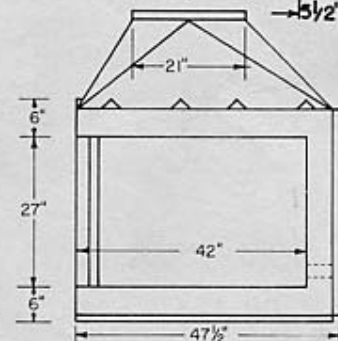

FRONT

**TYPICAL OFFSET INSTALLATIONS** (See separate instructions):

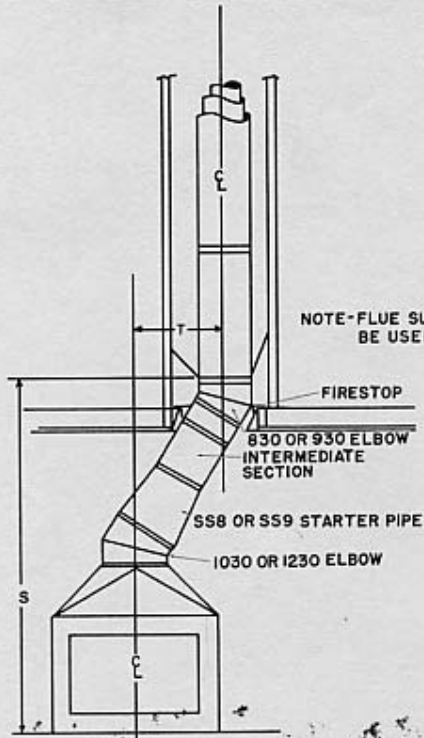

**USING 30° ELBOWS & SS8 or SS9 STARTER PIPE**

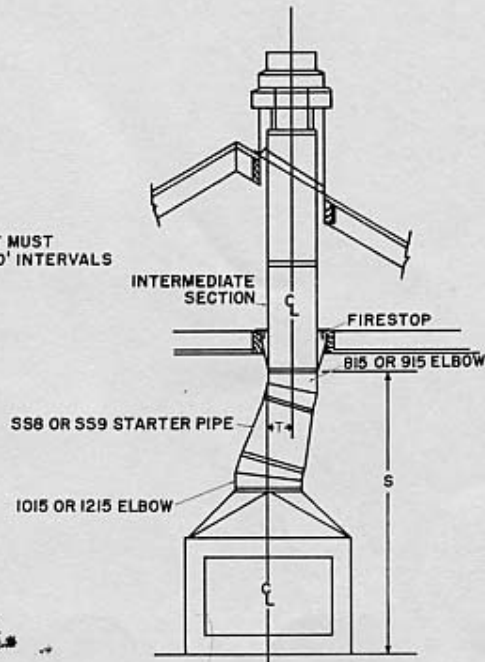

**USING 15° ELBOWS & SS8 or SS9 STARTER PIPE**

	Dim. "T" In Inches		Dim. "S" In Inches		
	L28A	L36A, L42A	L28A	L36A	L42A
For L28A & L36A: 1030, Elbow; SS8, Starter; 830, Elbow					
For L42A: 1230, Elbow; SS9, Starter; 930, Elbow					
No Section Added	16"	86"	90"	90"	94"
One 1' Section	22"	96"	100"	100"	104"
One 18" Section	25"	100"	104"	104"	108"
One 2' Section	28"	106"	110"	110"	114"
One 1' & One 18" Sections	31"	109"	113"	113"	117"
One 3' Section	35"	115"	119"	119"	123"
One 2' & One 18" Sections	37"	120"	124"	124"	128"
Two 2' Sections	40"	125"	129"	129"	133"
One 3' & One 18" Sections	43"	130"	134"	134"	138"
One 3' & One 2' Sections	46"	134"	138"	138"	142"
Two 2' & One 18" Sections	49"	140"	144"	144"	148"
Two 3' Sections	53"	144"	148"	148"	152"

	Dim. "T" In Inches		Dim. "S" In Inches		
	L28A	L36A, L42A	L28A	L36A	L42A
For L28A & L36A: 1015 Elbow; SS8-Starter; 815 Elbow					
For L42A: 1215 Elbow; SS9-Starter; 915 Elbow					
No Section Added	7"	85"	89"	89"	93"
One 1' Section	10"	95"	99"	99"	103"
One 18" Section	12"	101"	105"	105"	109"
One 2' Section	13"	106"	110"	110"	114"
One 1' & One 18" Sections	15"	111"	115"	115"	119"
One 3' Section	17"	117"	121"	121"	125"
One 2' & One 18" Sections	18"	122"	126"	126"	130"
Two 2' Sections	19"	127"	131"	131"	135"
One 3' & One 18" Sections	21"	133"	137"	137"	141"
One 3' & One 2' Sections	22"	139"	143"	143"	147"
Two 2' & One 18" Sections	23"	144"	147"	147"	151"
Two 3' Sections	25"	150"	154"	154"	158"

*extra 5" w. rashed*

**STARTER PIPE DIMENSIONS:**

**STRAIGHT**

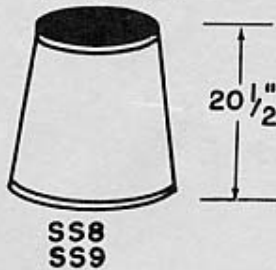

**FLUE SUPPORT**



**NOTE:** Chimney may incline left, right or rear as viewed from front of the Fireplace.



## INSTALLING THE CHIMNEY:

**STEP 1.** Installation of Majestic Thulman Fireplace Chimney may be made at any time after Fireplace has been set in desired location, preferably before any framework has been constructed around Fireplace to facilitate access to chimney connections.

**STEP 2.** Cut and frame openings through ceiling and roof levels (see opening sizes, Page 5). These sizes allow proper clearance between chimney and combustible construction. Roof opening should be cut to chimney housing to provide for attic ventilation.

**STEP 3.** Fasten triple-wall stainless steel starter pipe (with large diameter DOWN) or, large elbow, so that snaps engage. The three sections (inner, middle and outer) may be installed one at a time, starting with the inner one, or it may be necessary to hold middle and outer sections up toward ceiling opening while installing inner section. Be sure snap-locks engage all three sections of starter pipe or elbow to corresponding three rims of fireplace flue outlet.

**STEP 4.** At each ceiling level, install a firestop, with angle extending into joist space, and nail it to joist and headers around ceiling opening. No firestop is to be used at roof level.

**STEP 5.** Intermediate sections, consisting of inner stainless steel flue pipe, middle pipe and outer pipe, are installed like starter pipes. Continue with the intermediate sections until they extend through roof and above highest part of roof opening and at least high enough to fit 3" or more around telescoping pipe (in top housing). (CAUTION, see step 6 if sections are too long.)

**STEP 6.** T18 TOP HOUSING FLASHINGS (2 pieces). Center flashing (lower section under upper section) over roof opening. Nail each upper bracket to framing with a lead-headed screw nail. Cut top housing to proper length and pitch (see Page 6). Lower cut-off top housing over intermediate sections and slip sides of housing between "fingers" of flashing brackets. (CAUTION, at this step, check the height of the intermediate sections to be sure top falls within the dimensions shown at right.) Slide lower section of flashing down until inside flange rests against housing. Securely nail lower section by using lead-headed nails through holes in mounting brackets. (See separate instructions packed with T Series and Round Chimney Top Housings.) Using holes in mounting brackets as guides, punch or drill holes in top housing and metal-screw (two screws in each bracket). When roofing is laid, securely nail outer edges of flashing.

**T22 FLASHING.** Center one-piece flashing over intermediate sections. Nail securely through mounting brackets, using lead-headed nails. Cut top housing to pitch and length (see Page 6). Lower top housing over flashing, slipping sides between "fingers" of brackets. (CAUTION, at this step, check the height of the intermediate sections to be sure top falls within the dimensions shown at right.) Using holes in brackets as guides, punch holes in housing and metal-screw fast (2 screws to each bracket). When roofing is laid securely, nail outer edges of flashing.

**T40 & T62 FLASHINGS.** See Page 6 for installation instructions. (Be sure to observe the same caution note above about the height of the sections.)

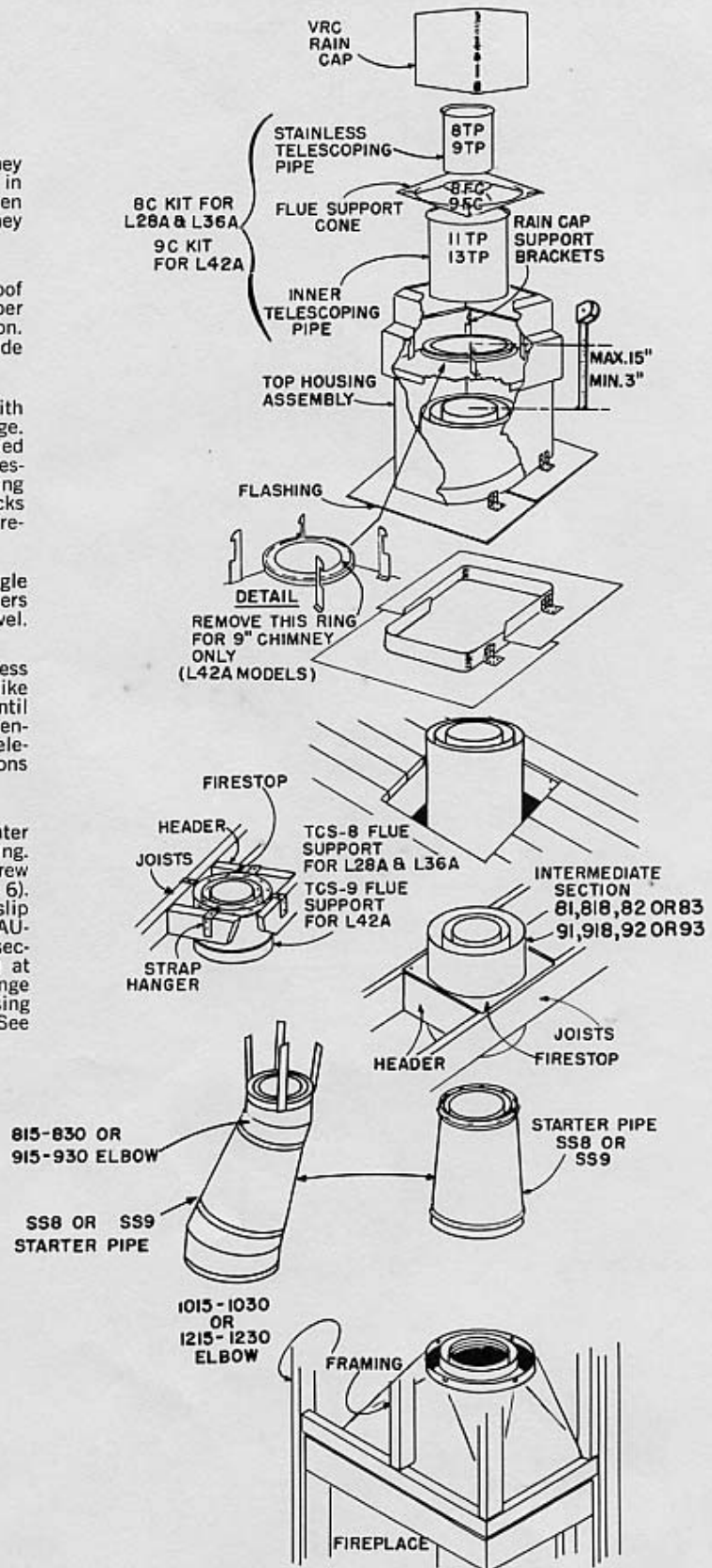

## INSTALLING THE CHIMNEY (continued):

**STEP 7.** Use 8C or 9C Adapter Kit, depending on flue diameter (8" or 9"). Slide larger telescoping pipe down through housing. Be sure this pipe enters flue 3" or more and that top rim of pipe rests on baffle in top housing to receive 13½" telescoping pipe when installing 42" fireplace. See detailed sketch.

**STEP 8.** Install flue support cone (cone up) with slots over vertical brackets, making sure brackets fit tight to outside edges of slots.

**STEP 9.** Slide stainless steel telescoping pipe through cone and into last section of flue pipe. Be sure this pipe enters 3" or more and that top rim rests on cone.

**STEP 10.** Install rain cap (all 4 vertical support brackets must be inside cap). Be sure each one snaps into slot in rain cap. Slight pressure downward is required for tight fit.

**STEP 11.** Complete installation should be inspected to assure all joints are locked and tight. Parts of chimney extending through accessible spaces should be enclosed. Chimney housing may be painted to suit architectural scheme. Check operation of fireplace damper, screens and security of back and side liners in combustion chamber.

## FRAMING FIREPLACE:

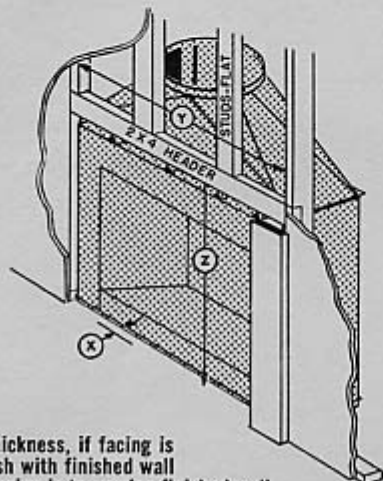

- X = Facing thickness, if facing is to be flush with finished wall
- X = Zero, if facing is to overlap finished wall
- Y = 46" for L36A; 53½" minimum for L42A
- Z = 33¾" for L28A; 35¾" for L36A; 39¼" minimum for L42A

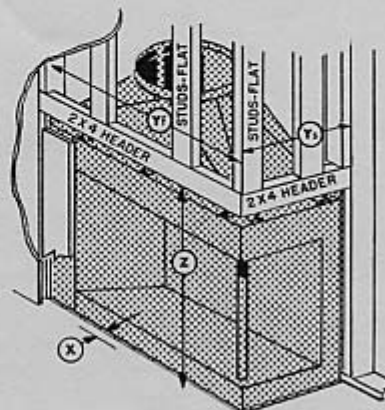

- X = Facing thickness, if facing is to be flush with finished wall
- X = Zero, if facing is to overlap finished wall
- Yf = 41" for L36AR & L36AL; 47½" for L42AR & L42AL
- Ys = 24" for L36AR & L36AL; 24½" for L42AR & L42AL

Fireplace may be properly located and framing built around it, or framing may be prepared and fireplace positioned later. In the latter case, fireplace must be pushed into position from rear.

Framework around the fireplace opening is illustrated above. Dimensions are shown also (Page 2) to facilitate construction of framing and enclosure.

Framing may be completed before delivery, if dimensions for enclosure are followed closely, particularly those in reference to framing around opening, (dimensions X, Y and Z). In illustration, Dimension "X" indicates position of finished wall surface with respect to surround face of fireplace.

As a general rule, when moulding or trim piece is to be installed around surround, finished surround is best installed

FLUSH with finished wall so a simpler trim piece may be used to cover joint. Position of header and framework around opening must be adjusted to accommodate thickness of finished surround when fireplace sits tight against wall at rear. If choice of finished surround is made AFTER INSTALLATION, it is suggested that framing be installed so finished surround will OVERLAP finished wall ("X"=Zero). Enclosure around fireplace is constructed of 2x4's, or heavier, in conventional manner.

Studs may be placed flat to conserve space. No clearances are required between framing and fireplace. Header across opening must be 2x4 if wall is non-supporting, and may rest on V-angles on fireplace front ledge. Refer to catalogs and price lists for surrounds, hearth extensions and bases.

## FRAMING CEILING & ROOF OPENINGS:

Frame ceiling and roof opening directly above one another, as flue should go straight up to top housing. Firestops must be used at each ceiling, but none is required at roof line. Roof framing must be 2x6's or 2x4's and securely nailed, as

top housing and flashing are anchored to this construction and must withstand heavy wind loads. NOTE: Opening dimensions are measured horizontally.

### CEILING OPENINGS

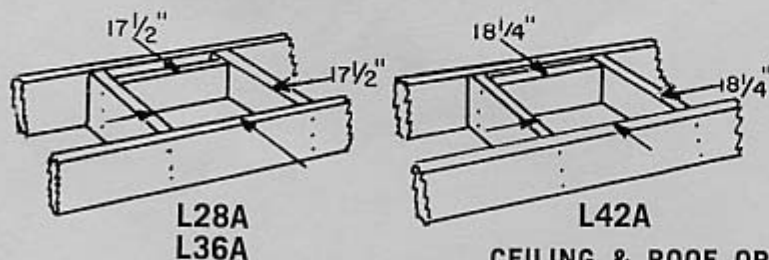

### ROOF OPENINGS

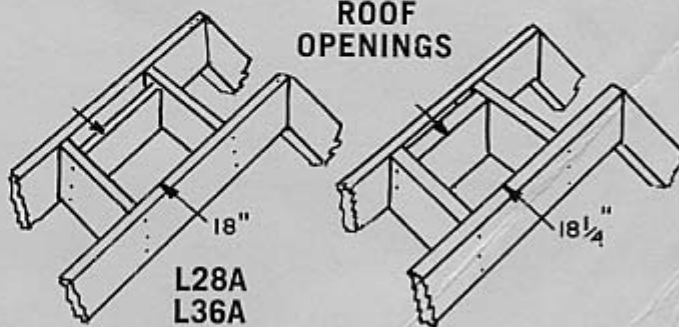

### CEILING & ROOF OPENING SIZES

Fireplace Chimney Size	Ceiling Opening	Roof Opening (horizontal)			
		T18	T22	T40	T62
8"	17½x17½	18x18	18x22½	22½x40	22½x62
9"	18¼x18¼	18¼x18¼	18¼x22½	22½x40	22½x62

L28A and L36A — 8" Chimney

L42A — 9" Chimney

## CUTTING TOP HOUSING TO HEIGHT & PITCH:

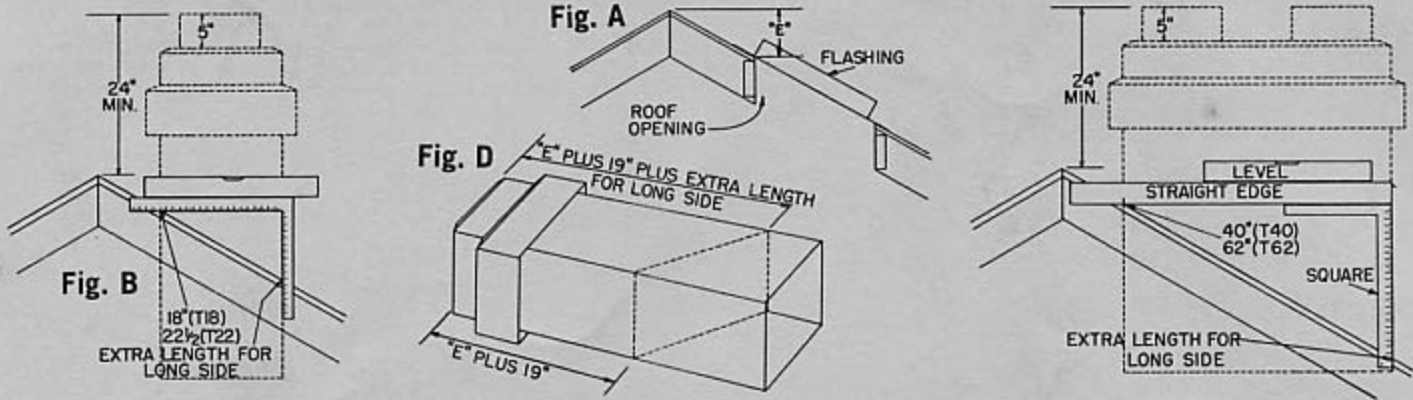

Determine "E" dimension (Fig. A). Add 19" to "E" to obtain height of short side of top housing (rain cap extends 5" above housing to give required total height of 24" above roof peak). Using a level and a square, as shown in Fig. A, B & C, determine height of long side of housing. Note that a straight edge is also needed with larger top housings. Scribe diagonal lines to correspond with roof pitch and cut housing with tin snips (a hacksaw may be needed at heavy corners). Mounting of T18 and T22 are shown in the sketches below. T22 should be installed with 18" side parallel to roof ridge as shown.

**MOUNTING T40 or T62 AT RIGHT ANGLE TO RIDGE:** Metal-screw mounting brackets to cut-off housing, (see drawings, below ) and form top and bottom brackets to roof pitch. Nail upper edge of upper half of flashing in position. Lay all other flashing in position as shown. Caulk each joint. Set top housing over flashing parts. Pull lower section of flashing down. Nail all flashing parts fast to roof through holes in brackets (use lead-headed nails). Also nail edges of flashing securely, leaving lower edges loose so roofing can be laid underneath.

**MOUNTING T40 or T62 PARALLEL TO RIDGE:** Follow same procedure as described above. Flashing parts are placed side by side, as shown below. Also see "Alternate."

**ALTERNATE** — Cut up corners and bend high side to roof pitch. Follow same procedure described above. Nail securely and lay roofing over top of this angle.

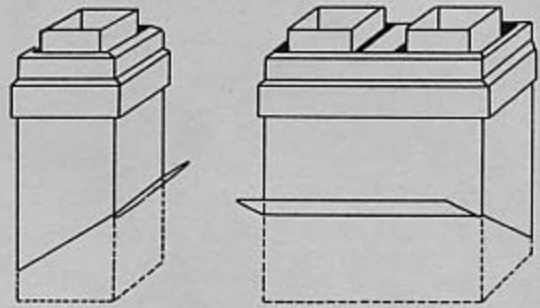

## TOP HOUSINGS — CUT TO PITCH & HEIGHT:

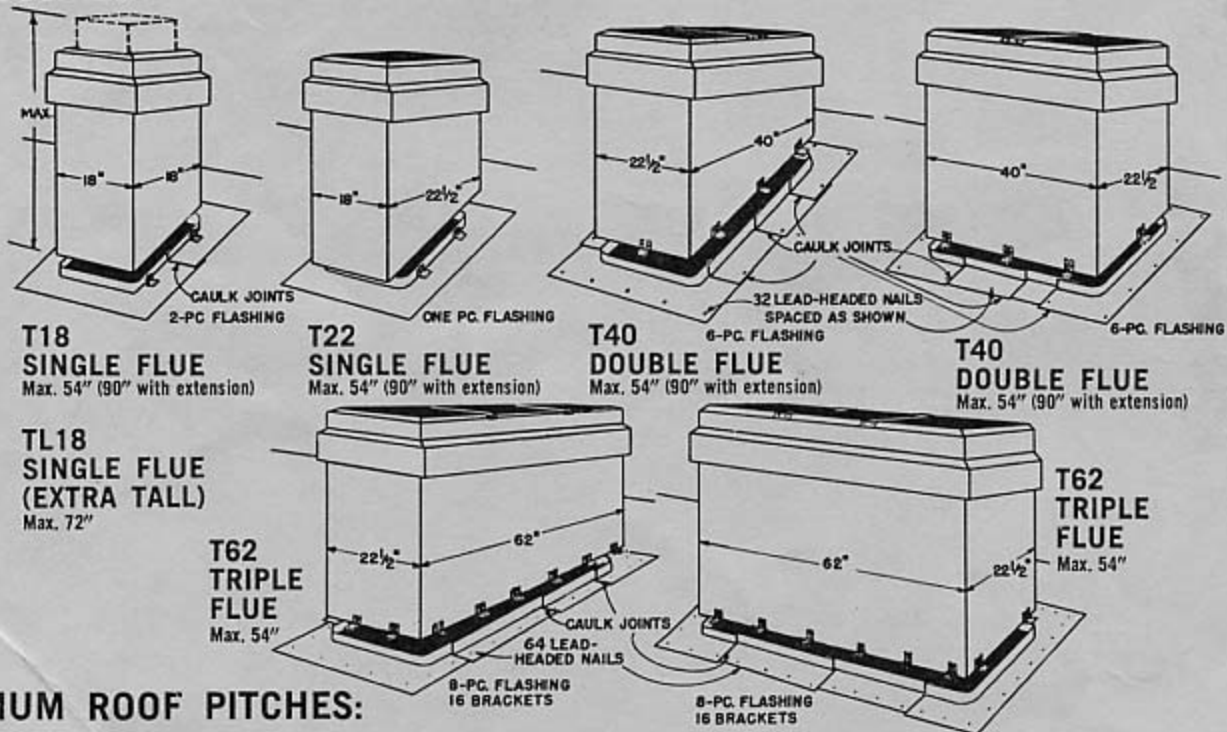

## MAXIMUM ROOF PITCHES:

T18 — 8" Chimneys 11/12 pitch	T22 — 8" Chimneys 12/12 pitch	T40 — 8" Chimneys At right angle or parallel — 12/12 pitch	T62 — 8" Chimneys At right angle or parallel — 12/12 pitch
T18 — 9" Chimneys 4/12 pitch	T22 — 9" Chimneys 12/12 pitch	T40 — 9" Chimneys At right angle or parallel — 12/12 pitch*	T62 — 9" Chimneys 12/12 pitch

\*NOTE: When pitch exceeds 9/12 on T40, 36" chimney extension must be used, when chimney top housing is installed at right angle to roof ridge.

Soldered flashing available by order. Specify Pitch.



847 741 5903  
 Majestic Dealer  
 Elgin Lenore

## CHIMNEY EXTENSIONS:

Chimney extensions have brick design, finished to match top housings in Red, Tan or White.

**INSTALLATIONS:** Top edge of chimney extensions have "S" locks. (Slide bottom end of chimney top housing into this joint and metal-screw these parts together at points 6" apart.)

Cut length and pitch as given on Page 6. **NOTE** — On installation where top housing is located far from roof ridge and where roof pitch exceeds those given on Page 6, it may be necessary to cut through this joint and into regular top housing (use hacksaw if needed). Use 2 additional brackets for T18, 4 for T22 and 10 for T40 extensions as shown.

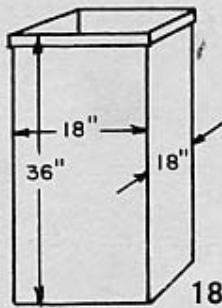

18-18-36

  
 2 EXTRA  
 MOUNTING  
 BRACKETS

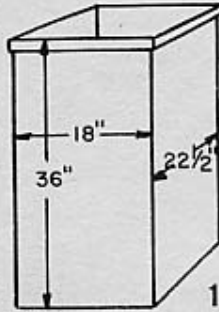

18-22-36

  
 4 EXTRA  
 MOUNTING  
 BRACKETS

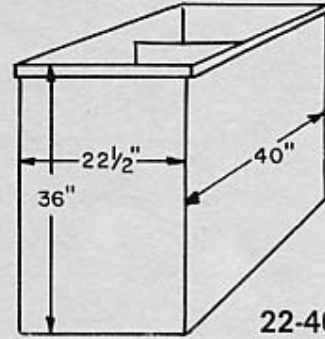

22-40-36

  
 10 EXTRA  
 MOUNTING  
 BRACKETS

## SPECIAL SOLDERED FLASHINGS:

Soldered flashings for standard top housings are recommended on roofs with unusual pitches or where chimney comes through roof at peak. If in doubt, write Majestic's Engineering Department.

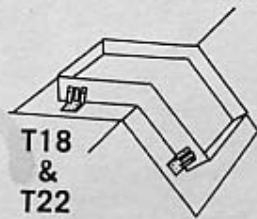

T18  
&  
T22

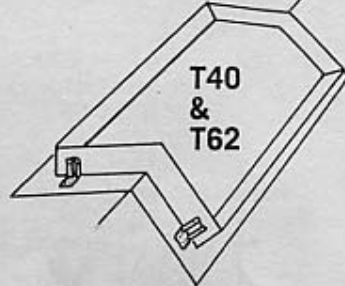

T40  
&  
T62

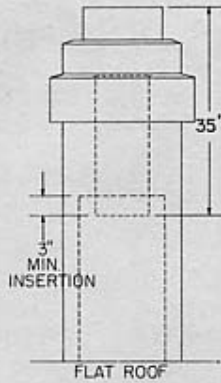

## FLAT ROOFS:

For flat or low-pitched roofs, full length of top housing should be used. This will require an extra 2' length of intermediate section. Soldered flashings recommended if water stands on flat roof.



SOLDERED  
FLASHING

## "A" FRAME HOUSES:

Standard chimney top housing flashings cannot be used with "A" frame houses. Order special soldered flashing, giving model number of top housing and exact roof pitch. For T22, T40 or T62, make sketch showing proposed location and position of top housing on roof.

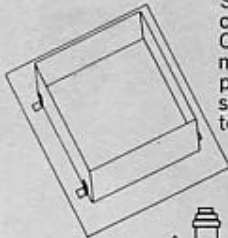

SOLDERED  
FLASHING

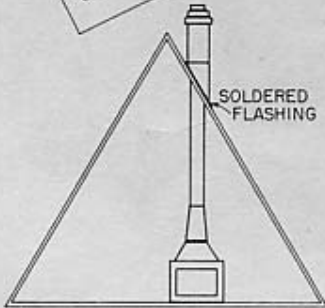

## FLAT RAIN CAP:

FRC

The "V" Baffle Rain Cap (No. VRC) is standard for most applications. In some areas of unusual wind or rain conditions, a Flat Rain Cap may be desired. The Majestic No. FRC may be used instead of the VRC.

## GAS LOG-LIGHTER

All Majestic Thulman Fireplaces have been designed with provision for inserting 1/2" gas line for a log-lighter. All OPEN-FRONT MODELS have a gas line access tube through lower right of unit behind solid liner. The units are shipped with liners installed, solid panel on right (covering the access hole provision in case log-lighter is not to be used), and liner with plugged hole near the top, on the left. If log-lighter is to be installed, remove liners and reverse positions (left to right). With liners removed you will find a square metal plate covering the log-lighter access tube through the lower right side of the firebox. Remove this plate. This hole continues through the side of the unit and is filled with insulation. Remove the insulation. Snap out the hole plug from the liner, which has already been switched from left to right, and align with the cleared tube hole through the side of the fireplace. With correct liner in place you'll have a 1 1/4" hole available for the gas line. After log-lighter gas line is in place, repack the insulation around line. All OPEN-END MODELS are shipped with the liner in correct position and the liner hole plugged directly over the access tube through the fireplace. Remove the liner and follow same procedure to completion.



# THULMAN FIREPLACE & CHIMNEY INSTALLATION INSTRUCTIONS

## MULTIPLE-FLUE TOP HOUSING INSTALLATIONS:

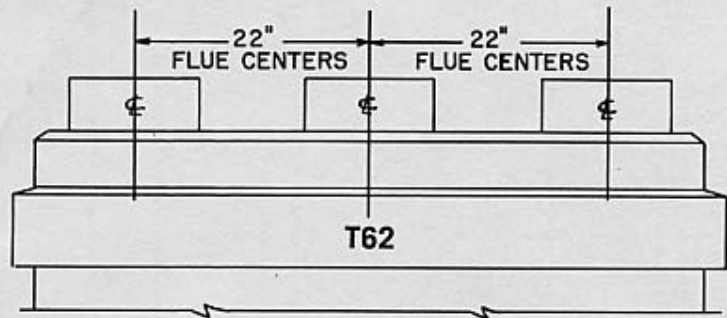
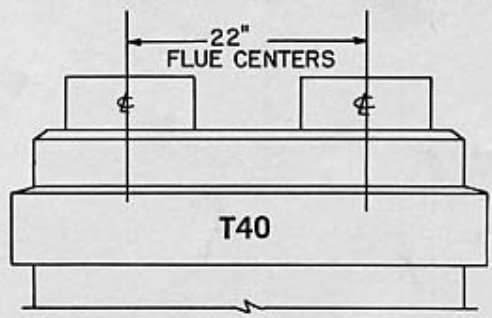

T40 top housing receives 2 flues and T62 top housing receives 3 flues. These top housings may have a combination of any of the following: L28A Fireplaces, L36A Fireplaces, L42A Fireplaces, 7", 8" and 9" all-purpose flue (for Oil Furnaces Incinerators, Free-Standing Fireplaces etc.), 5", 6", 7" and 8" gas

vent, or one opening may be blank (use BL Kit to close blank flue opening). Follow these instructions when multiple fireplaces are used. If all-purpose chimneys and gas vents are used, follow instructions furnished with equipment. Each additional flue requires a rain cap and corresponding adapter kit.

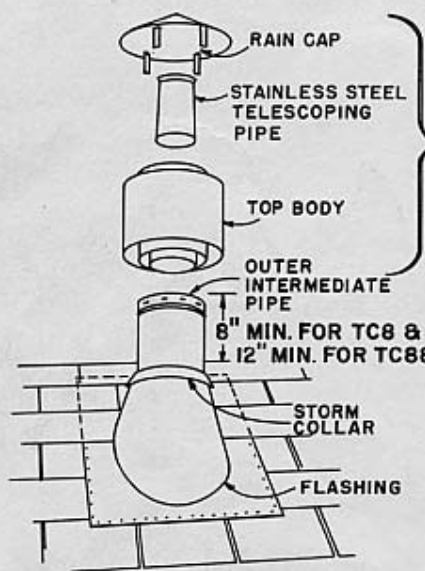

## CONTEMPORARY ROUND CHIMNEY TOP HOUSING:

Model TC8-TC88 for L28A and L36A Fireplaces  
Model TC9-TC99 for L42A Fireplace



TC88 WIRE ENCLOSED,  
TC99 SLIM LINE PROFILE  
TOP HOUSING.

### ADDITIONAL PARTS REQUIRED TO COMPLETE FIREPLACE

Fireplace Models	Flue Size	Starter Pipes	Firestop	Intermediate Sections	Flashing & Storm Collar
L28A, L36A Series	8"	SS8	FS2	82/83	8- 6-12 8-12-12
L42A Series	9"	SS9	FS3	92/93	9- 6-12 9-12-12

### FIREPLACE ROOF OPENING SIZES

Fireplace Model	Flue Size	Roof Opening Size
L28A, L36A Series	8"	17½ x 17½
L42A Series	9"	18¼ x 18¼

### HOW TO TRIM FLASHING

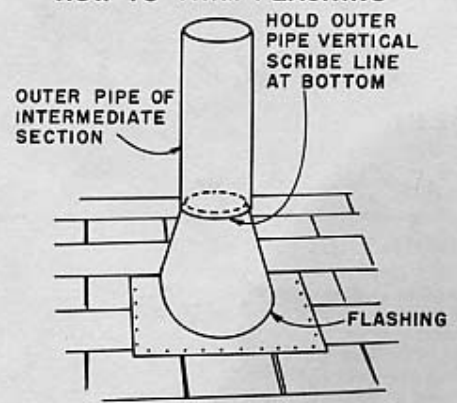

An American-Standard Company  
FORM NO. BF-1/272 LITHO IN U.S.A.

THE MAJESTIC COMPANY, HUNTINGTON, INDIANA 46750